

# MedLinket



**ECG NIBP**  
Pulse **SpO<sub>2</sub>** C.O.  
Temp. **ICG**  
**AED** EEG **IBP**  
EMG **RESP**  
**ETCO<sub>2</sub> ESU**



## PRODUCT CATALOG 2025

Focusing on providing high-quality medical sensors and cable assembly for Anesthesia, ICU, Neonatal & Emergency Departments

A collection of medical cables and connectors, including a multi-pin connector, several single-pin connectors in various colors (red, black, white, brown, green), and a white connector labeled 'RA'.

# CONTENTS

## EEG

01 [▶](#)

Disposable Non-invasive EEG Sensor

## EEG/EMG

04 [▶](#)

EEG EMG Sensor & Leadwires

## SpO2

13 [▶](#)

SpO2 Sensors & Adapter Cables

## EtCO2

112 [▶](#)

EtCO2 Sensors & Accessories

## Temp

130 [▶](#)

Temperature Probes & Adapters

## ECG

154 [▶](#)

ECG Cables & Leadwires

## EKG

210 [▶](#)

Diagnosis EKG Cables & Accessories

## AED

229 [▶](#)

Disposable Defibrillation Pads

## ICG

232 [▶](#)

Disposable ICG Electrode

## NIBP

234 [▶](#)

NIBP Cuffs & Accessories



## **IBP**

**272** [▶](#)

IBP Adapter Cables & Transducer

## **ESU**

**298** [▶](#)

ESU Pencil & Leadwires

## **Respiration**

**309** [▶](#)

Ventilator Accessories

### \*Remark:

Because of the constant upgrading of the products, some of the pictures are different from real products, please be subject to the real one. Besides, not all MED-LINKET products are included in this catalogue, welcome call for inquiry

### \*Declaration:

All registered trademark and brand style mentioned in this catalogue is always belonging to original equipment manufacturer. We only cite for machine compatibility use, no any other purpose exist. This is only for reference use; please do not take it as working guidance. Otherwise, we will not be responsible for any possible cost. This catalogue has been carried out since February 1, 2021, we would not further of the patient issues Med-link products might be involved with in the marketed ares, and are responsible for the relevant legal affairs.

©2021 Shenzhen Med-link Electronics Tech Co.,Ltd. All right are reserved. Reproduction in whole or in part is prohibited without the prior written consent of the copyright holder. Printed in the Shenzhen P.R.C.

## ABOUT MEDLINKET

Shenzhen Med-link Electronics Tech Co., Ltd. (hereinafter referred to as Medlinket) focuses on providing high-quality medical sensors and cable components for ICU and anesthesia operation. It is a national high-tech enterprise integrating R & D, manufacturing, marketing and service. Founded in Longhua of Shenzhen since 2004, with more than 450 employees, including factories in Shenzhen and shaoguan, covering an area of 10000 square meters.

Dedicated to the world's leading life signal acquisition experts, Medlinket has always been focusing on "customer-centric, striving-oriented, and highlight as example! Credit, integrity, win-win, responsibility, collaboration, innovation, growth", always Adhere to the mission of "make medical care easier and people healthier". Being down-to-earth and striving for excellence, Medlinket products are sold all over the world, become an indispensable part of human health.



SHENZHEN FACTORY



# COMPANY CULTURE



**Mission:** Make medical care easier and people healthier.

**Vision:** To become the world's leading expert in life signal acquisition, play an indispensable role of human health.

**Values:** Customer-centered, striver-oriented, and highlights as a model integrity.

## Collaboration



## Responsibility

## Integrity Win-win Concept



## Innovation Growth



# Certification

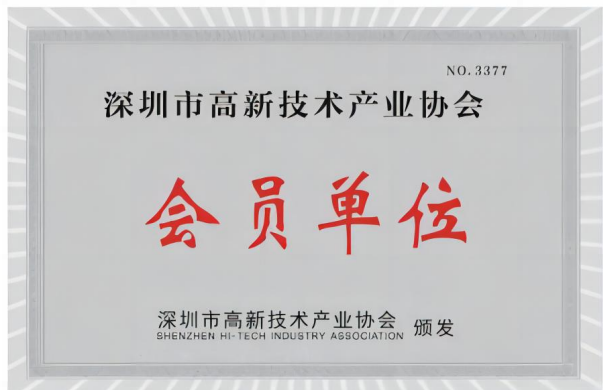

- National High-tech and New Third Board
- Enterprises with the Most Investment Value
- Medical device production license and registration certificate
- Has 22 national utility model patents, 3 invention patents, 7 appearance design patents and 11 copyrights
- NMPA (National Medical Products Administration)
- ISO13485/FDA/CE
- CMDCAS Medical Device Licence
- Obtained the Anvisa certificate issued by the Brazilian Health Agency
- Japan FMA Medical Device License
- Biocompatible report

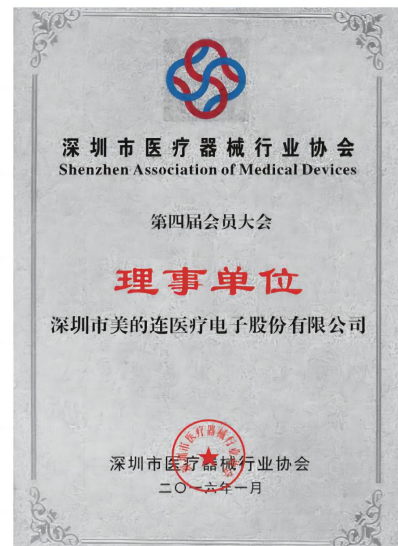
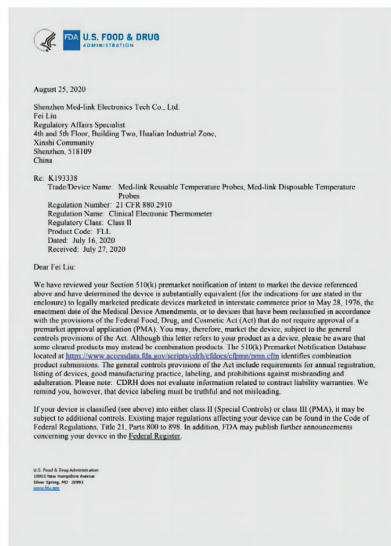

# Core Strengths

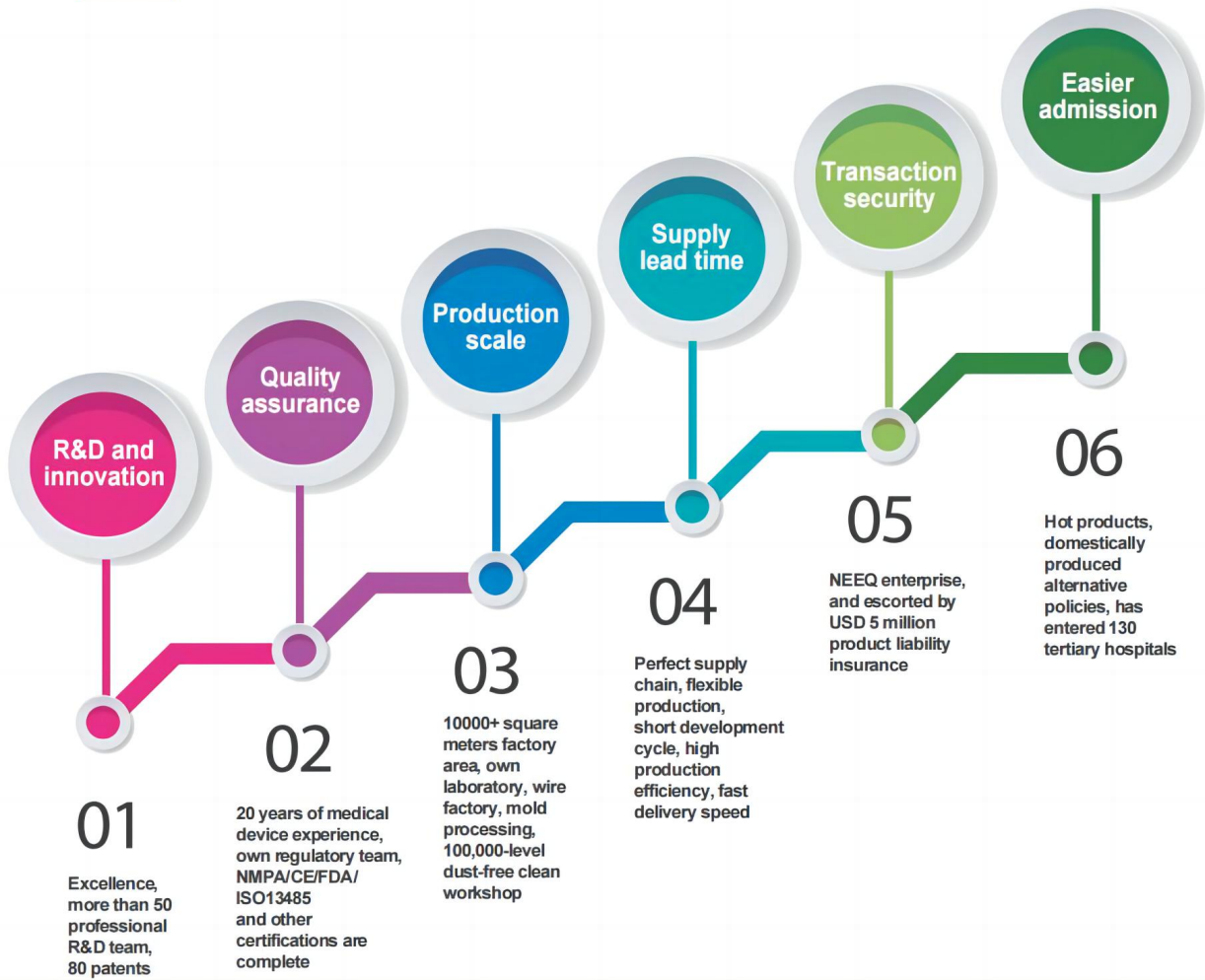

# Main Exhibitions



中华医学会  
CHINESE MEDICAL ASSOCIATION



# Sales Distribution



## OEM Vs. MED-LINKET

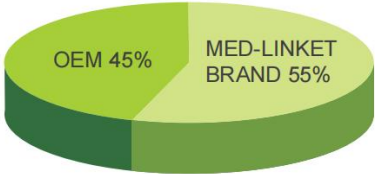

## Export Vs. Domestic Market

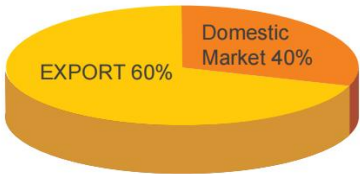

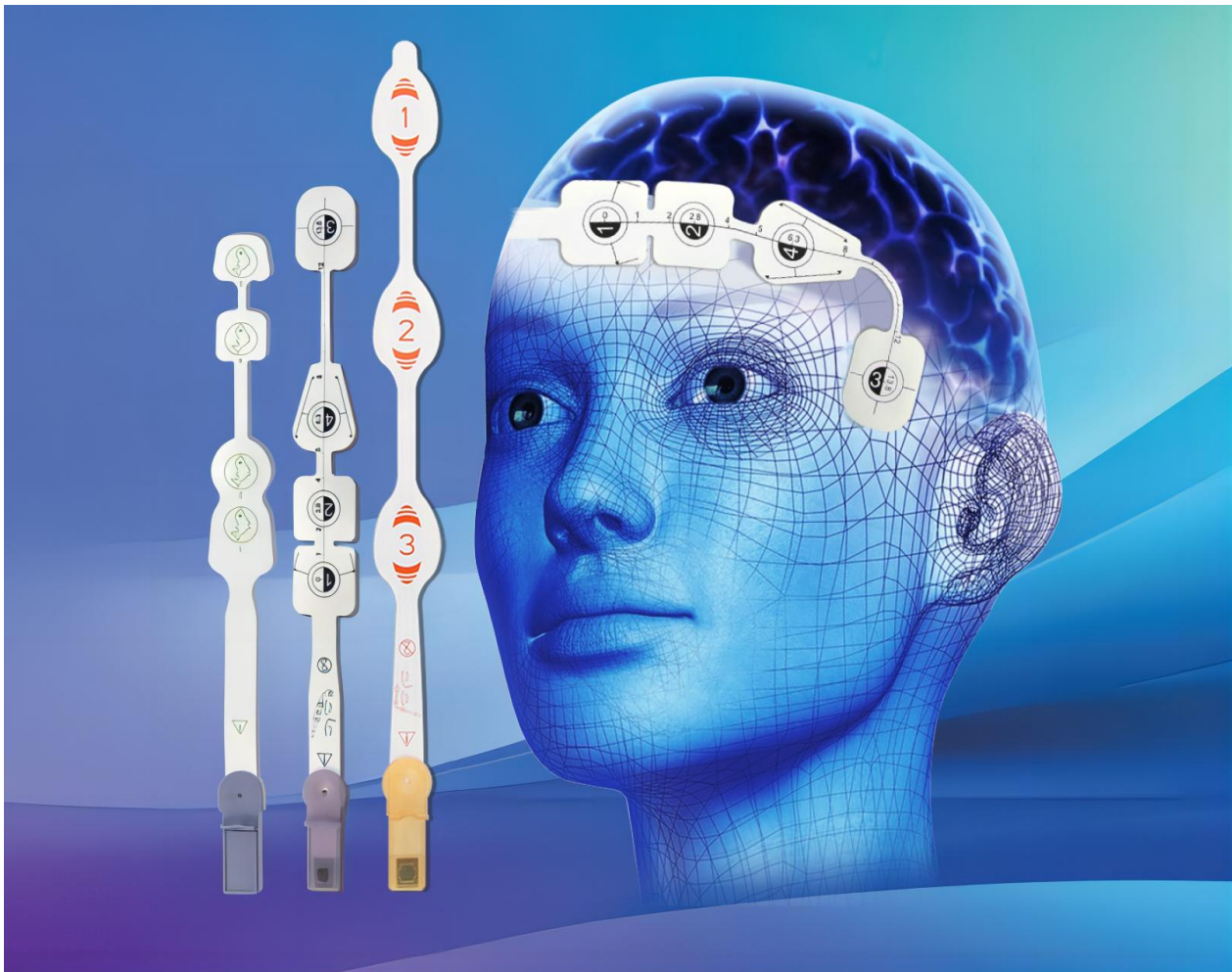







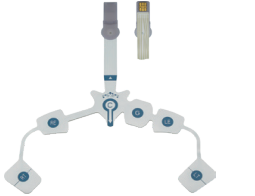

## Disposable Non-invasive EEG Sensor

### Product Features

1. More than 10 years of experience in the development of hemp deep electrodes and 20 years of experience in adapter development, supporting products with better compatibility;
2. Rich in products, we can provide sensors that are compatible with BIS, CSI, PSI, IOC, NTI, Entropy Index and other technologies;
3. We can provide dealers with a variety of adapter cables to support the development of new hospitals and increase usage;
4. Can provide connectors with better waterproof performance, suitable for head surgery;
5. The electrode size is small and can be used simultaneously with cerebral oxygen on the forehead.

Order Code	Original Part Number	Product Picture	Description	Compatible Module	OEM Manufacturer & Models
9902040904	186-0106		Adult, 4 LD	Double channel Bispectral Index Module (BIS)	Monitor using BIS module: Philips IntelliVue MP40/MP50/MP60/MP70; GE Dash Series, Eagle Series, Solar 8000 Series, Datex Ohmeda S/5 Series; Mindray BeneView Series; Dräger Infinity Delta, Kappa, Delta XL;
9902040502	186-0200		Pediatric, 4 LD		
9902060902	186-0212		Adult, 6 LD	Four channel Bispectral Index Module (BIS)	
9903030906	/		Adult, 3 LD	Entropy Index Module (EI)	GE B20/B40
B-BIS-3A	/		Adult, 3 LD	Index of Consciousness Module (IOC)	Level of Consciousness Monitor, IoC-View Monitor 08001
B-BIS-6A-01	2479		Adult, 6 LD	Patient State Index Module (PSI)	Masimo SedLine Brain Function Monitoring
B-BIS-3AL	/		Adult, 3 LD, Left Electrode	Cerebral State Index Module (CSI)	GMI G9D/G9L/G9M/G9N
B-BIS-3AR	/		Adult, 3 LD, Right Electrode		

Order Code	Original Part Number	Product Picture	Description	Compatible Module	OEM Manufacturer & Models
B0050I	186-0107		10pin to 6pin socket, 1.3m	Double channel Bispectral Index Module	Monitor using BIS module: Philips IntelliVue MP40/MP50/MP60/MP70; GE Dash Series, Eagle Series, Solar 8000 Series, Datex Ohmeda S/5 Series; Mindray BeneView Series;
B0052A	186-1018		12pin to 6pin socket, 1.3m	Four channel Bispectral Index Module (BIS)	
B0051A	M1050784		9pin to 6pin socket, 3.5m	Entropy Index Module (EI)	GE B20/B40
B0050A	/		4pin to 6pin socket, 2.4m	Index of Consciousness Modul (IOC)	Level of Consciousness Monitor, IoC-View Monitor 08001
B0061A	/		9pin to 9pin socket, 0.9m	Patient State Index Module (PSI)	Masimo SedLine Brain Function Monitoring
B0065I	/		4pin to 6pin socket, 2.5m	Cerebral State Index Module (CSI)	GMI G9D/G9L/G9M/G9N



# EEG/EMG Sensor & Leadwires

## CONTENTS

1. EEG Lead Wires with Electrodes
2. Sterile Disposable Subdermal Needle Electrodes
3. Pelvic Floor Muscle Rehabilitation Probe

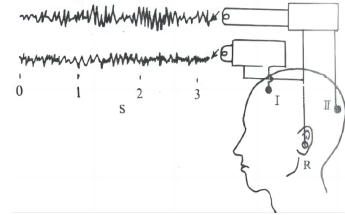

### Instrument Connect

143

134

112



### Patient End Termination or Electrodes

T

P

N





Order Code	Picture	Descriptions
------------	---------	--------------

Socket		
CT0254 Series		Din 1.0mm double socket, Multi color available: CT0254A (Black), CT0254D (Orange), CT0254C (Blue), CT0254B (Yellow)
CT0068 Series		Din 1.5mm single socket, Multi color available: Black, Brown, Red, Orange, Yellow, Green, Blue, Purple, Grey, White
CT0111 Series		Din 1.5mm single straight socket, Multi color available: Black, Brown, Red, Orange, Yellow, Green, Blue, Purple, Grey, White

Order Code	Instrument	Side	Descriptions (Name, Connector, Color, Length)
------------	------------	------	---

EEG Lead wires with Electrodes			
B143-T-BLA-60			Tooth type grabber EEG cord, 143>T, Black, L=60" (1.5m), 5pcs/bag
B143-T-RED-60			Tooth type grabber EEG cord, 143>T, Red, L=60" (1.5m), 5pcs/bag
B143-T-GRN-60			Tooth type grabber EEG cord, 143>T, Green, L=60" (1.5m), 5pcs/bag
B143-P-BLA-30			Cup Electrode EEG cord, 143>P, Black, L=30in" (750mm), 5pcs/bag
B143-P-BLA-60			Cup Electrode EEG cord, 143>P, Black, L=60in" (1.5m), 5pcs/bag
B143-P-RED-60			Cup Electrode EEG cord, 143>P, Red, L=60in" (1.5m), 5pcs/bag
B143-P-GRN-30			Cup Electrode EEG cord, 143>P, Green, L=30in" (750mm), 5pcs/bag
B143-P-GRN-60			Cup Electrode EEG cord, 143>P, Green, L=60" (1.5m), 5pcs/bag
B708-P-BLA-45			Compatible Biomedical Instruments EEG lead wires, 12 Lead, Radiotransparent Leadwires, Cup electrode.
B143-DP-10-40			Disposable EEG electrodes, Preattached Leadwires, Copper wires, 10 lead-Wire Set, L=40" (1m)
B143-DP-10-60			Disposable EEG electrodes, Preattached Leadwires, Copper wires, 10 lead-Wire Set, L=60" (1.5m)
B143-DP-10-80			Disposable EEG electrodes, Preattached Leadwires, Copper wires, 10 lead-Wire Set, L=80" (2m)
B143-DP-10-100			Disposable EEG electrodes, Preattached Leadwires, Copper wires, 10 lead-Wire Set, L=100" (2.5m)
CT0086A			EEG Electrode, Metal: Cu/AgCl, 10pcs/pk
SL0760A			Disposable EEG Cup Electrodes, 9.2mm diam, AgCl, 20pcs/pack

## EEG/EMG Lead wires with Electrodes

OEM Manufacturer & Models	Order Code	OEM #	Photo	Descriptions (Name, Connector, Color, Length)
Nihon Kohden, Natus Medical, Medtronic (Covidien), Compumedics, Micromed, Cadwell, EGI, NCC Medical, SYMTOPI, NEUROWERK, etc.	B143-S-10-72			EMG 10 lead-Wire Set, snap,72in
	B143-S-10-96			EMG 10 lead-Wire Set, snap,96in
	B143-S-10-120			EMG 10 lead-Wire Set, snap,120in
	B143-S-5I-72			ECG 5 lead-Wire Set, snap,IEC,72in
	B143-S-5A-72			ECG 5 lead-Wire Set, snap,AHA,72in
	B143-P-10-48			Cup Electrode EEG cord, 10 lead-Wire Set, 48in
	B143-P-10-72			Cup Electrode EEG cord, 10 lead-Wire Set, 72in
	B143-P-10-96			Cup Electrode EEG cord, 10 lead-Wire Set, 96in
	B143-P-10-120			Cup Electrode EEG cord, 10 lead-Wire Set, 120in

## OEM & ODM Service

- Medlinket is a leading provider of sockets, signal wires, medical cable and lead wires, electrode materials, processing technology, mould and product technical standard for ECG, EEG and EMG.
- OEM and ODM are available, which are supported by a wide range of technical support and services from experienced engineers.
- Let us know what you design or think, then we will do the rest as you imaged.

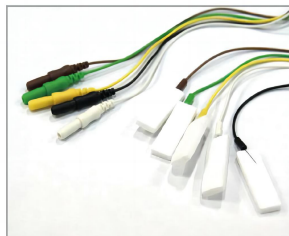
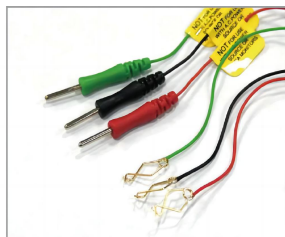
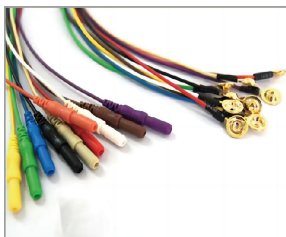

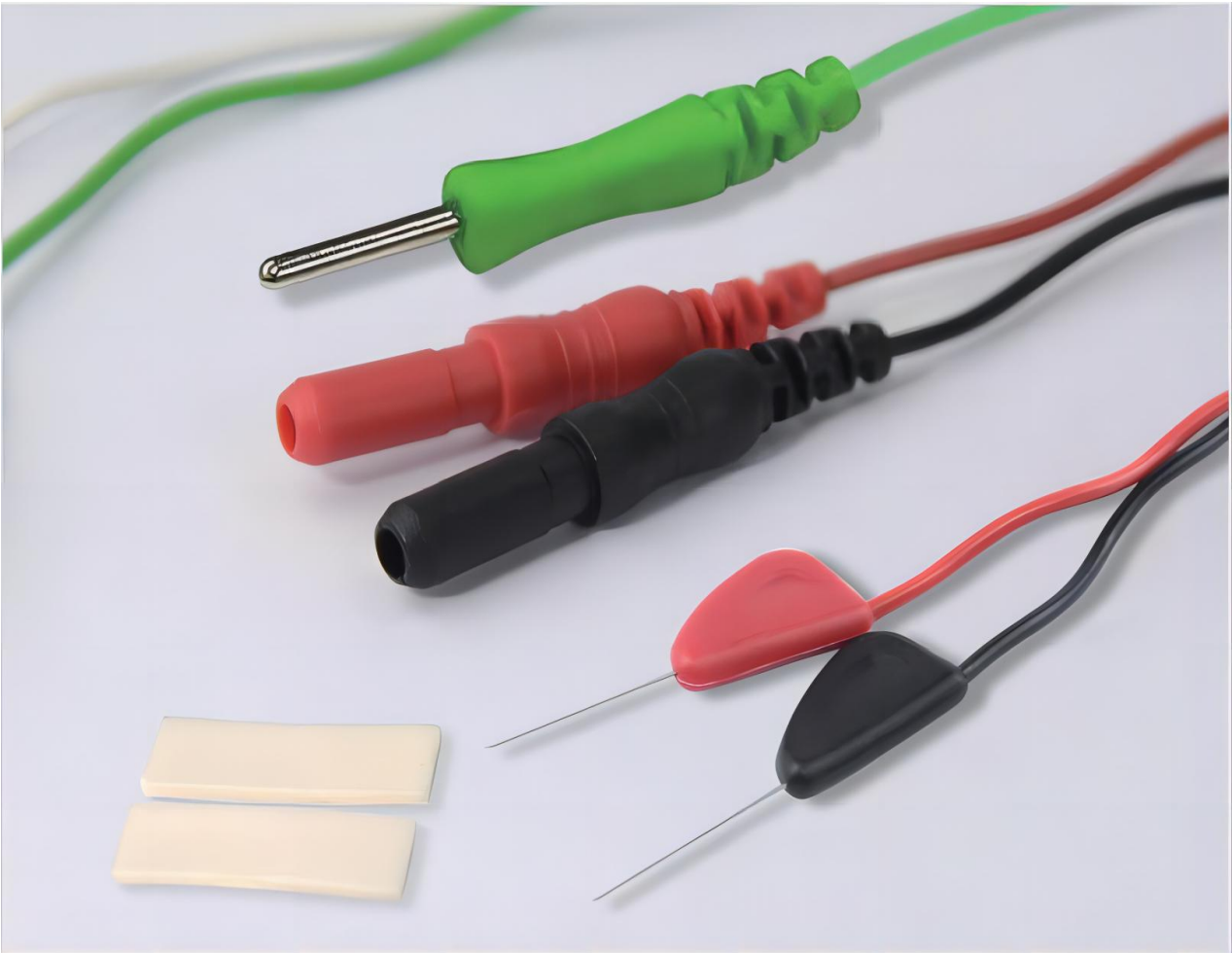









# 1 Sterile Disposable Subdermal Needle Electrodes

## Product Features

1. Sterilized by EO gas, Single patient use only;
2. To provide easy and secure recording when placed directly into the scalp;
3. Made of stainless steel and designed for strength and flexibility;
4. The tip is sharpened with precision to an ultra-sharp lancet cut for easy penetration;
5. The twisted lead wires reduce noise and impedance levels giving a clean, clear signal.

Instrument Side	OEM #	Order Code	Descriptions			Package
			Electrode Length	Electrode Diameter	Plug, Leadwire	
		B143-N-GRN-60	14mm/0.55in	0.40mm/27gauge	DIN Style, green plug, 1.5m, single wire	1pcs/bag 20pcs/box
		B143-N-RED-60	14mm/0.56in	0.40mm/28gauge	DIN Style, red plug, 1.5m, single wire	1pcs/bag 21pcs/box
		B143-N-WHE-60	14mm/0.57in	0.40mm/29gauge	DIN Style, white plug, 1.5m, single wire	1pcs/bag 22pcs/box
		B143-N-PUR-60	14mm/0.58in	0.40mm/30gauge	DIN Style, purple plug, 1.5m, single wire	1pcs/bag 23pcs/box
		B143-N-BLU-60	14mm/0.59in	0.40mm/31gauge	DIN Style, blue plug, 1.5m, single wire	1pcs/bag 24pcs/box
		B143-N-YEL-60	14mm/0.60in	0.40mm/32gauge	DIN Style, yellow plug, 1.5m, single wire	1pcs/bag 25pcs/box
		B143-N-BRO-60	14mm/0.61in	0.40mm/33gauge	DIN Style, brown plug, 1.5m, single wire	1pcs/bag 26pcs/box
		B143-N-ORA-60	14mm/0.62in	0.40mm/34gauge	DIN Style, orange plug, 1.5m, single wire	1pcs/bag 27pcs/box

Instrument Side	OEM #	Order Code	Descriptions			Package
			Electrode Length	Electrode Diameter	Plug, Leadwire	

**Two Twisted Disposable Subdermal Needle Electrodes**

    		B143-N-BLU	12mm/0.5in	0.40mm/27gauge	DIN 1.5, 1.5m, Green and white, blue and black twisted pairs	1set/bag 20set/box
		B143-N-BRO	12mm/0.6in	0.40mm/28gauge	DIN 1.5, 1.5m, Green and white, brown and black twisted pairs	1set/bag 21set/box
		B143-N-ORA	12mm/0.7in	0.40mm/29gauge	DIN 1.5, 1.5m, Green and white, orange and black twisted pairs	1set/bag 22set/box
		B143-N-PUR	12mm/0.8in	0.40mm/30gauge	DIN 1.5, 1.5m, Green and white, purple and black twisted pairs	1set/bag 23set/box
		B143-N-RED	12mm/0.9in	0.40mm/31gauge	DIN 1.5, 1.5m, Green and white, red and black twisted pairs	1set/bag 24set/box
		B143-N-YEL	12mm/0.10in	0.40mm/32gauge	DIN 1.5, 1.5m, Green and white, yellow and black twisted pairs	1set/bag 25set/box





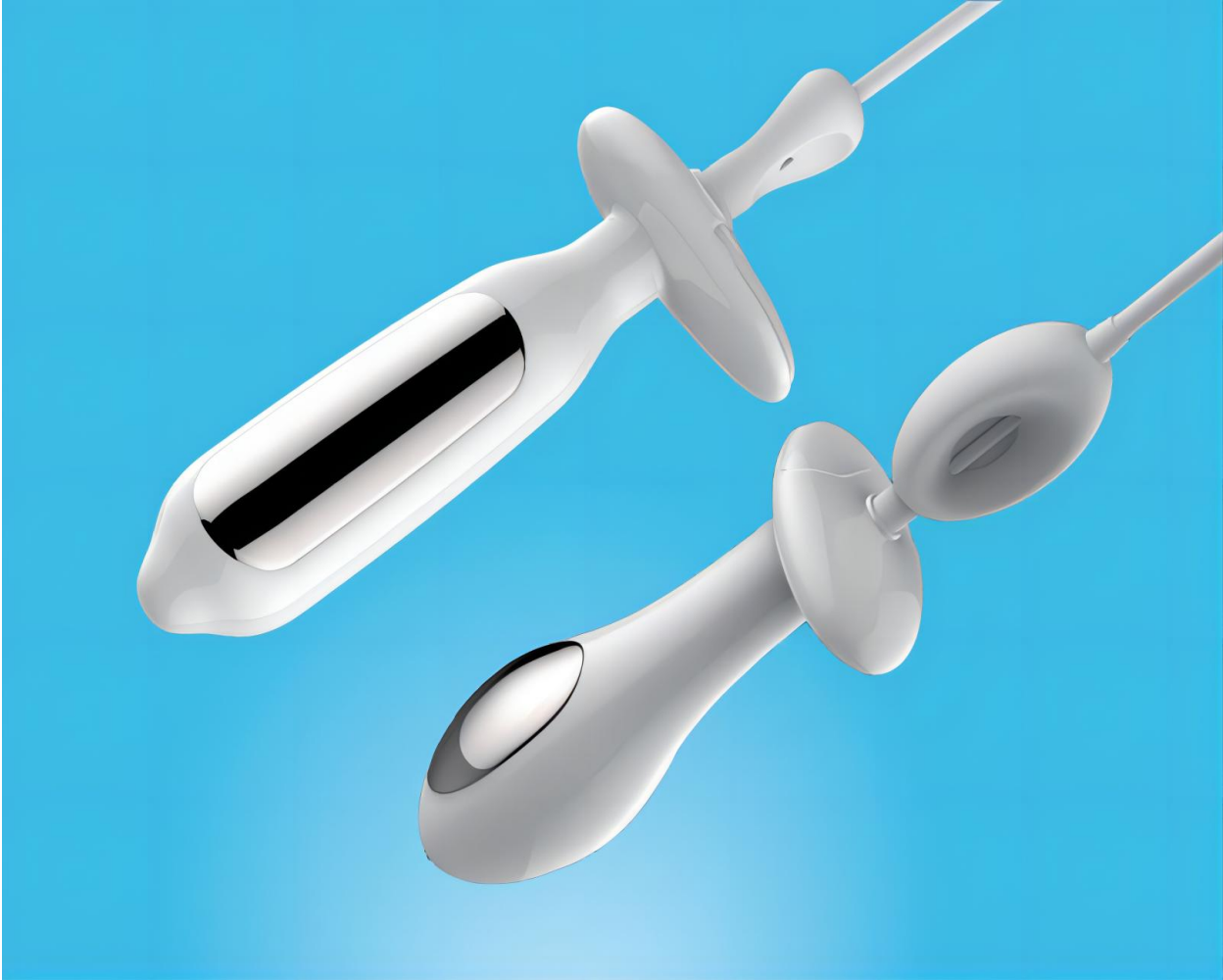

Model: Nr. 15.1-25, Nr. 15.1-28,  
Nr. 15.1-38, Nr. 15.1-50, Nr. 15.1-60  
Name: EMG Needle  
Size: 25mm, 28mm, 38mm, 50mm, 60mm



## 2 Pelvic Floor Muscle Rehabilitation Probe

### Product Features

1. Pelvic floor muscle probes designed on the foundation of customers demand and ergonomics are compatible with all types of hosts and play a role in health care;
2. The probes integrally designed have a smooth surface, which, to maximum degree, promote the comfort;
3. Flexible handle design not only can make it easy to place and remove probe, the handle can also be bent and hidden to protect privacy when wearing pants.

Brand	Picture	Order Code	Sensor Type	Specification	Package
<b>Order Information</b>					
Med-linke		PE0001	Rectal Pelvic Floor Muscle Rehabilitation Probe	Line length approximately 0.68m	1 pc/Bag
		PE0002	Vaginal Pelvic Floor Muscle Rehabilitation Probe	Line length approximately 0.68m	1 pc/Bag
		PE0003	Vaginal Pelvic Floor Muscle Rehabilitation Probe	Line length approximately 0.32m	1 pc/Bag
		PE0010	Vaginal Pelvic Floor Muscle Rehabilitation Probe	Line length approximately 0.68m	1 pc/Bag
		PE0020	Rectal Pelvic Floor Muscle Rehabilitation Probe	Line length approximately 0.68m	1 pc/Bag

### New Product PE0010

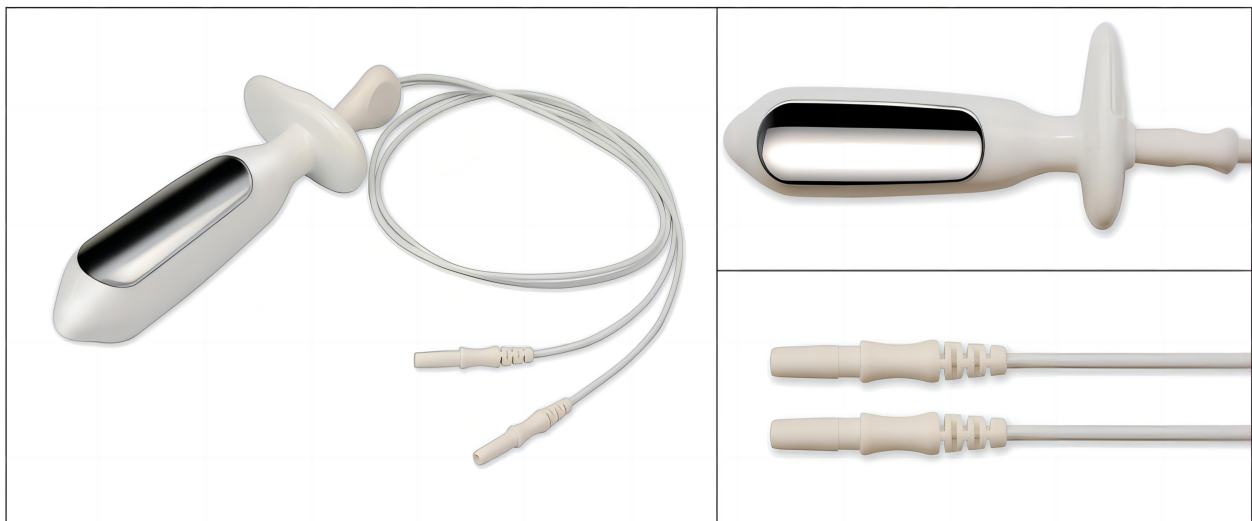

## Surface electrodes for nerve and muscle stimulators



### Product Features

1. Disposable use, avoiding cross-infection;
2. High-quality conductive hydrogel with good viscosity and low contact resistance;
3. Good biocompatibility, Latex free, free from biological hazard to skin.

### Scope of Application

It is used on the skin surface to conduct the electrical stimulation signal output by the electrotherapy equipment to the human body through the conductive material.

### Product Specifications

OEM Manufacturer & Models	Order Code	Description	Package
<b>Biostimulation feedback instrument, electrophysio_x005f logical parameter monitor, electrophysiological stimulator, physiotherapy instrument</b>	TE001NW	Din type 2.0, tail wire electrode, 100*50mm	2pcs/bag
	TE002NW	Din type 2.0, tail wire electrode, 50*50mm	3pcs/bag



## SpO<sub>2</sub> Sensors & Adapter Cables



S0026OX-L



S0015OX-L



S0190TS-L



S0442CS-L

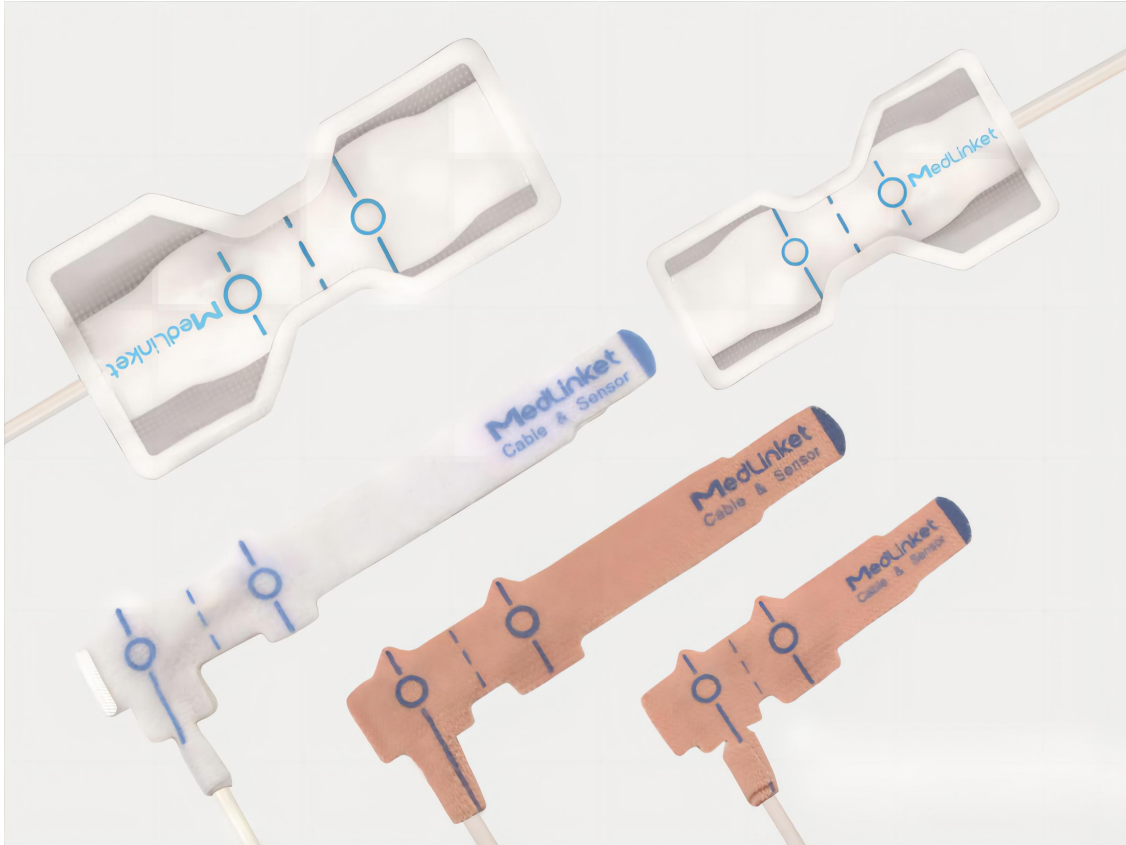

# 1 Disposable SpO<sub>2</sub> Sensors

## Code Rule Description

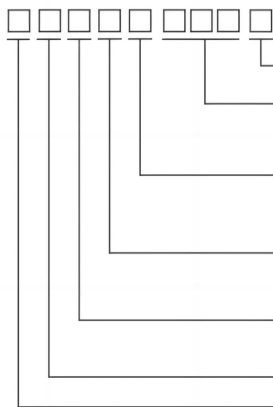

**Length specification:**  
1: 0.45m; 2: 0.9m

**Compatible feature No.:**  
010(Nellcor), 026(Nellcor-Oximax)

**Tape style or material:** 1: microfoam;  
2: transpore; 3: fabric; 4: elastic fabric;  
5: comfort foam;  
6: transpore(Medlinket new design);  
7: elastic fabric(Medlinket new design);  
8: comfort foam(Medlinket new design)

**Suitable patient size:** 1: adult;  
2: pediatric; 3: infant; 4: adult/pediatric/infant/  
neonate

**Product series:**  
1: S0026 series; 2: S0010 series;  
3: S0136 series; 4: S0010 series with  
temperature measurement function;

0: Disposable unsterilized SpO<sub>2</sub> sensors  
1: Disposable sterilized SpO<sub>2</sub> sensors

**Sales area:** 9: CN; 6: EU

## Product Features

1. Disposable, used by single patient without cross infection;
2. High accuracy: evaluation of SpO<sub>2</sub> accuracy by comparing arterial blood gas analyzers;
3. Good compatibility: it can be adapted to the mainstream brand monitor of the hospital, such as Nellcor, Masimo, GE, Philips, Mindray, etc.;
4. Safety guarantee: latex free, good biocompatibility, free from biological hazard to skin.



### Connector Type



## Sensor Type

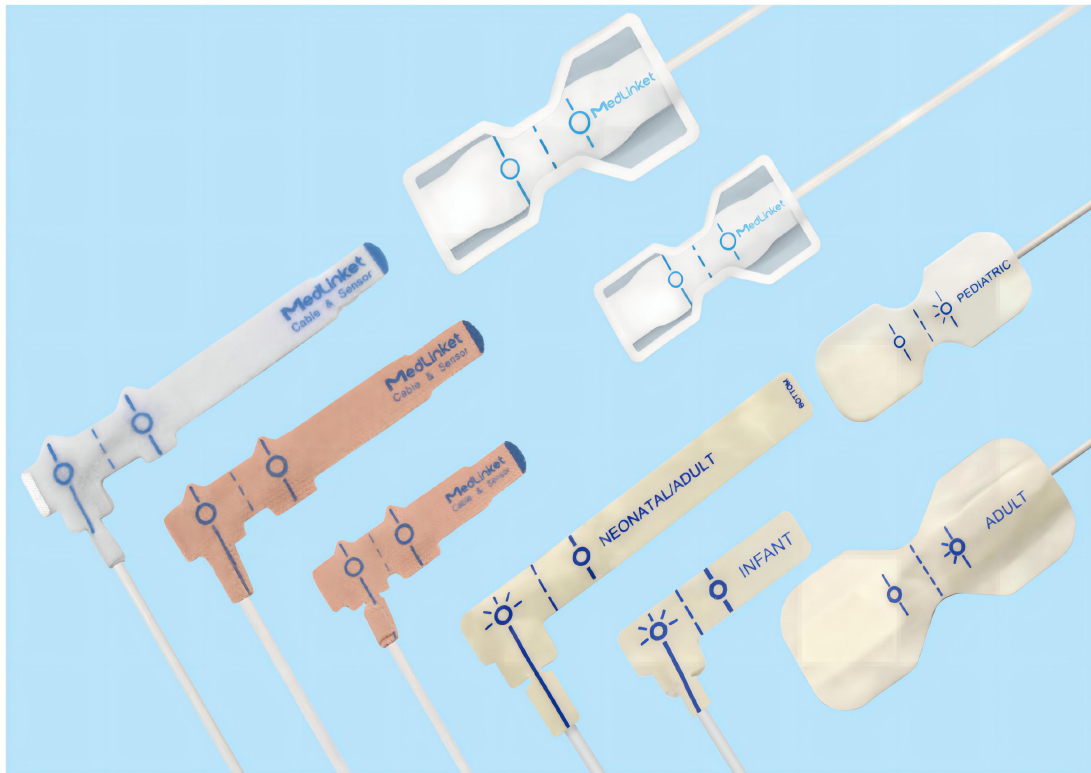

Sensor Picture	①	②	③	④	⑤
<b>Material</b>	Comfort Foam Non-Adhesive	Elastic Fabric Adhesive	Elastic Fabric Adhesive	3M Microfoam Adhesive	3M Microfoam Adhesive
<b>Use Schematic</b>					
<b>Application</b>	Neonate <3kg, Infant 3-20kg, Pediatric 10-50kg, Adult >30kg	Neonate <3kg, Infant 3-20kg, Pediatric 10-50kg, Adult >30kg	Infant 3-20kg	Neonate <3kg, Infant 3-20kg, Pediatric 10-50kg, Adult >30kg	Infant 3-20kg
<b>Application Site</b>	Neonate foot, infant toe, adult and pediatric finger	Neonate foot, infant toe, adult and pediatric finger	Great toe	Neonate foot, infant toe, adult and pediatric finger	Great toe
Sensor Picture	⑥	⑦	⑧	⑨	
<b>Material</b>	3M Microfoam Adhesive	3M Microfoam Adhesive	Transpore Adhesive	Transpore Adhesive	
<b>Use Schematic</b>					
<b>Application</b>	Adult >30kg	Pediatric 10-50kg	Pediatric 10-50kg	Adult >30kg	
<b>Application Site</b>	Index or other finger	Index or other finger	Index or other finger	Index or other finger	

## Product Advantages

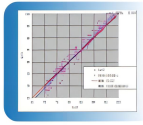

### High precision

1. Provide a reference blood gas analyzer for SpO<sub>2</sub> clinical validation report, accuracy meet the requirements of NMPA/FDA/CE standards;  
2. Optimize the wavelength of the light source and detector parameters through experimental design to adapt to different measurement areas such as thickness, skin color, gender, age, make sure accuracy and wider application range.



### Strong resistance to light interference

Inside with good anti light interference materials, it can maintain accuracy even under strong light.



### Accuracy

Unique sensor positioning design to avoid measurement errors and burn risks caused by severe misalignment between the light source and sensor.



### Comfortable

Breathable materials make patients more comfortable and reduce the impact of sweat on sensors.



### Unique patented design



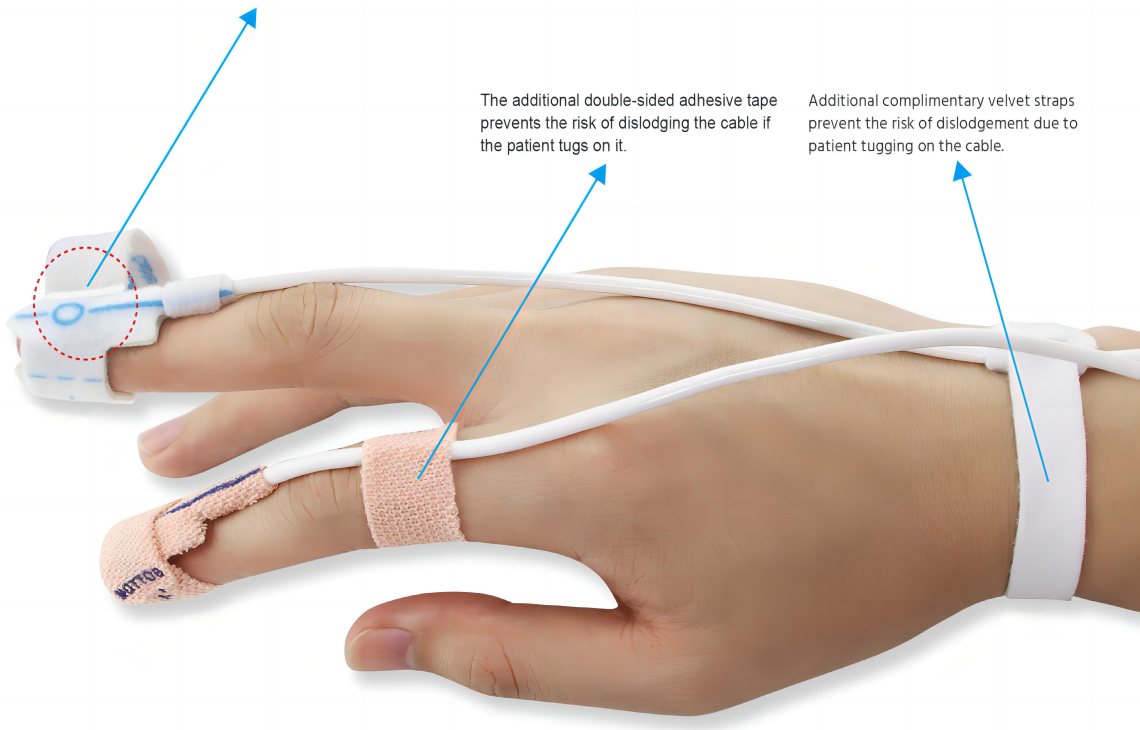

The wrapping tape can be quickly fixed when wrapping around the first circle of the patient's position, not easy to deviate, making the entire wrapping effect more firm and improving the quality of care.









The additional double-sided adhesive tape prevents the risk of dislodging the cable if the patient tugs on it.

Additional complimentary velvet straps prevent the risk of dislodgement due to patient tugging on the cable.







## Disposable SpO2 Sensors (New Sensor Appearance)

OEM Manufacturer & Models	Instrument Connector	OEM #	Patient Size	Microfoam (Adhesive Sensor)	Non-woven Fabric Adhesive	Elastic Fabric Adhesive	Comfort Foam Non-Adhesive	Transpore Adhesive	Price	Sensor Picture
<b>Compatible Masimo</b>										
Rad-5, Rad-57, Rad-8, Rad-87, (Compatible Masimo Tech)		1001 /LNOP Adtx	Adult		605130201			605160201		
		1025 /LN-OP Pdtx	Pediatric		605230201			605260201		
		1800 /LN-OP Inf-L	Infant			605370202				
		1798 /LN-OP Neo-L	Neonate/ Adult			605470202	605480202			
			Neonate (weight< 1.5kg)					605380202		
			Neonate/ Infant (weight: 1.5~20kg)					605280202		
Rad-5 Rad-57 Rad-8, Rad-87 (Compatible Masimo LNCS)		1859 /LN-CS Adtx	Adult		605134421			605164421		
		1860 /LN-CS Pdtx	Pediatric		605234421			605264421		
			Infant			605374422				
		2329 /LNCS Neo	Neonate/ Adult			605474422	605484422			
			Neonate (weight< 1.5kg)					605384422		
			Neonate/ Infant (weight: 1.5~20kg)					605284422		
Rad-5 Rad-57 Rad-8, Rad-87 (Compatible Masimo LNCS, opem system)		1859 /LN-CS Adtx	Adult		605132041			605162041		
		1860 /LN-CS Pdtx	Pediatric		605232041			605262041		
			Infant			605372042				
		2329 /LNCS Neo	Neonate/ Adult			605472042	605482042			
			Neonate (weight< 1.5kg)					605382042		
			Neonate/ Infant (weight: 1.5~20kg)					605282042		







## Disposable SpO2 Sensors (New Sensor Appearance)

OEM Manufacturer & Models	Instrument Connector	OEM #	Patient Size	Microfoam (Adhesive Sensor)	Non-woven Fabric Adhesive	Elastic Fabric Adhesive	Comfort Foam Non-Adhesive	Transpore Adhesive	Price	Sensor Picture	
<b>Compatible Masimo</b>											
Rad-5, Rad-57 Rad-8 Rad-87, (Compatible Masimo M-tech)			Adult		605135401			605165401			
			Pediatric		605235401			605265401			
			Infant				605375402				
			Neonate/Adult				605475402	605485402			
			Neonate (weight < 1.5kg)						605385402		
			Neonate/Infant (weight: 1.5~20kg)						605285402		
Rad-5, Rad-57, Rad-8, Rad-87, (Compatible Masimo RD)		4000	Adult		605134501			605164501			
		4001	Pediatric		605234501			605264501			
		4002	Infant				605374502				
		4003	Neonate/Adult				605474502	605484502			
		4005	Neonate (weight < 1.5kg)						605384502		
			Neonate/Infant (weight: 1.5~20kg)						605284502		







## Disposable SpO2 Sensors (New Sensor Appearance)

OEM Manufacturer & Models	Instrument Connector	OEM #	Patient Size	Microfoam (Adhesive Sensor)	Non-woven Fabric Adhesive	Elastic Fabric Adhesive	Comfort Foam Non-Adhesive	Transpore Adhesive	Price	Sensor Picture
<b>Compatible Nihon Kohden</b>										
Bedside Monitor: BSM-4101, 4103, 4111, 4113 Life scope P, BSM-5105, 5135 Life scope A, BSM-2351, 2353 Life scope L, BSM-2301, 2303 Life scope I		TL-251T	Adult		605130051			605160051		
		TL-252T	Pediatric		605230051			605260051		
		TL-252T	Infant			605370052				
		TL-253T	Neonate/Adult			605470052	605480052			
			Neonate (weight< 1.5kg)					605380052		
			Neonate/Infant (weight: 1.5~20kg)					605280052		
<b>Compatible Nonin</b>										
Nonin: 8500, 8600, 8700, 8800		6000CA/7000A	Adult		605130801			605160801		
		6000CP/7000P	Pediatric		605230801			605260801		
		6000CI/7000I	Infant			605370802				
		6000CN/7000N	Neonate/Adult			605470802	605480802			
			Neonate (weight< 1.5kg)					605380802		
			Neonate/Infant (weight: 1.5~20kg)					605280802		







## Disposable SpO2 Sensors (New Sensor Appearance)

OEM Manufacturer & Models	Instrument Connector	OEM #	Patient Size	Microfoam (Adhesive Sensor)	Non-woven Fabric Adhesive	Elastic Fabric Adhesive	Comfort Foam Non-Adhesive	Transpore Adhesive	Price	Sensor Picture	
<b>Compatible Nellcor</b>											
Nellcor-Tech OxiMax		MAX-A	Adult		605130261			605160261			
		MAX-P	Pediatric		605230261				605260261		
		MAX-I	Infant				605370262				
MAX-N	Neonate/ Adult				605470262	605480262					
	Neonate (weight< 1.5kg)						605380262				
	Neonate/ Infant (weight: 1.5~20kg)						605280262				
Nellcor-Tech OxiSmart		D25	Adult		605130101			605160101			
		D20	Pediatric		605230101				605260101		
		120	Infant				605370102				
N25	Neonate/ Adult				605470102	605480102					
	Neonate (weight< 1.5kg)						605380102				
	Neonate/ Infant weight 1.5-20kg)						605280102				







## Disposable SpO2 Sensors (New Sensor Appearance)

OEM Manufacturer & Models	Instrument Connector	OEM #	Patient Size	Microfoam (Adhesive Sensor)	Non-woven Fabric Adhesive	Elastic Fabric Adhesive	Comfort Foam Non-Adhesive	Transpore Adhesive	Price	Sensor Picture	
<b>Compatible Philips</b>											
M3, M4, MP20, MP30, MP40, MP50, MP70, MP80, VM4, VM6, VM8			Adult		605130151			605160151			
			Pediatric		605230151			605260151			
			Infant			605370152					
			Neonate/Adult			605470152	605480152				
			Neonate (weight< 1.5kg)					605380152			
			Neonate/Infant (weight: 1.5~20kg)						605280152		
<b>Compatible GE</b>											
GE-TruSignal+ (GE B650)			Adult		605131901			605161901			
			Pediatric		605231901			605261901			
			Infant			605371902					
			Neonate/Adult			605471902	605481902				
			Neonate (weight< 1.5kg)					605381902			
			Neonate/Infant (weight: 1.5~20kg)						605281902		
GE-Datex Ohmeda (GE-OxyTip+, 3740, 3710, only use for Ohmeda oximeter, EMITTER: 660/905/940-4)		OXY-AP	Adult		605131231			605161231			
			Pediatric		605231231			605261231			
			Infant			605371232					
		OXY-AF	Neonate/Adult			605471232	605481232				
			Neonate (weight< 1.5kg)					605381232			
			Neonate/Infant (weight: 1.5~20kg)						605281232		











## Disposable SpO2 Sensors (New Sensor Appearance)

OEM Manufacturer & Models	Instrument Connector	OEM #	Patient Size	Microfoam (Adhesive Sensor)	Non-woven Fabric Adhesive	Elastic Fabric Adhesive	Comfort Foam Non-Adhesive	Transpore Adhesive	Price	Sensor Picture
<b>Compatible Comen (China)</b>										
Comen C70 C30			Adult		605135421			605165421		
			Pediatric		605235421			605265421		
			Infant			605375422				
			Neonate/ Adult			605475422	605485422			
			Neonate (weight< 1.5kg)					605385422		
			Neonate/ Infant (weight: 1.5~20kg)					605285422		
<b>Compatible Biolight (China)</b>										
A Series; Q Series S Series After 2019 encryption (Digital Tech)			Adult		605135151			605165151		
			Pediatric		605235151			605265151		
			Infant			605375152				
			Neonate/ Adult			605475152	605485152			
			Neonate (weight< 1.5kg)					605385152		
			Neonate/ Infant (weight: 1.5~20kg)					605285152		
A Series; Q Series M Series Before 2018 (Digital Tech,open system)  Note: The encrypted sensor above can be replaced by this sensor with the adapter (S0165OB-A) and adapter cable (S0165DO-L/S).			Adult		605131651			605161651		
			Pediatric		605231651			605261651		
			Infant			605371652				
			Neonate/ Adult			605471652	605481652			
			Neonate (weight< 1.5kg)					605381652		
			Neonate/ Infant (weight: 1.5~20kg )					605281652		









## Disposable SpO2 Sensors (New Sensor Appearance)

OEM Manufacturer & Models	Instrument Connector	OEM #	Patient Size	Microfoam (Adhesive Sensor)	Non-woven Fabric Adhesive	Elastic Fabric Adhesive	Comfort Foam Non-Adhesive	Transpore Adhesive	Price	Sensor Picture	
<b>Compatible Medlinket</b>											
AM805, 806 (TYPE-C)			Adult		605135571			605165571			
			Pediatric		605235571			605265571			
			Infant			605375572					
			Neonate/Adult			605475572	605485572				
			Neonate (weight<1.5kg)					605385572			
			Neonate/Infant (weight: 1.5~20kg)					605285572			
Multi-compatible			Adult		605131631			605161631			
			Pediatric		605231631			605261631			
			Infant			605371632					
			Neonate/Adult			605471632	605481632				
			Neonate (weight<1.5kg)					605381632			
			Neonate/Infant (weight: 1.5~20kg)					605281632			
Over-temp. Protection			Adult								
			Pediatric								
			Infant								
			Neonate/Adult					604480102			
			Neonate (weight<1.5kg)								
			Neonate/Infant (weight: 1.5~20kg)								









## Disposable SpO2 Sensors (Old Sensor Appearance)

OEM Manufacturer & Models	Instrument Connector	OEM #	Patient Size	Microfoam (Adhesive Sensor)	Non-woven Fabric Adhesive	Elastic Fabric Adhesive	Comfort Foam Non-Adhesive	Transpore Adhesive	Price	Sensor Picture
<b>Compatible Masimo</b>										
Rad-5, Rad-57, Rad-8, Rad-87, (Compatible Masimo Tech)		1001 /LNOP Adtx	Adult	S0020J-S	S0020J-SP			S0020J-ST		
		1025 /LN-OP Pdx	Pediatric	S0020K-S	S0020K-SP			S0020K-ST		
		1800 /LN-OP Inf-L	Infant	S0020L-L		S0020L-LP				
		1798 /LN-OP Neo-L	Neonate/ Adult	S0020M-L		S0020M-LP	S0020N-L			
Rad-5 Rad-57 Rad-8, Rad-87 (Compatible Masimo LNCS)		1859 /LN-CS Adtx	Adult	S0442J-S	S0442J-SP			S0442J-ST		
		1860 /LN-CS Pdx	Pediatric	S0442K-S	S0442K-SP			S0442K-ST		
			Infant	S0442L-L		S0442L-LP				
		2329 /LNCS Neo	Neonate/ Adult	S0442M-L		S0442M-LP	S0442N-L			
Rad-5 Rad-57 Rad-8, Rad-87 (Compatible Masimo LNCS, open system)		1859 /LN-CS Adtx	Adult	S0204J-S	S0204J-SP			S0204J-ST		
		1860 /LN-CS Pdx	Pediatric	S0204K-S	S0204K-SP			S0204K-ST		
			Infant	S0204L-L		S0204L-LP				
		2329 /LNCS Neo	Neonate/ Adult	S0204M-L		S0204M-LP	S0204N-L			
Rad-5, Rad-57 Rad-8, Rad-87, (Compatible Masimo M-tech)			Adult	S0540J-S	S0540J-SP			S0540J-ST		
			Pediatric	S0540K-S	S0540K-SP			S0540K-ST		
			Infant	S0540L-L		S0540L-LP				
			Neonate/ Adult	S0540M-L		S0540M-LP	S0540N-L			
Rad-5, Rad-57, Rad-8, Rad-87, (Compatible Masimo RD)		4000	Adult	S0450J-S	S0450J-SP			S0450J-ST		
		4001	Pediatric	S0450K-S	S0450K-SP			S0450K-ST		
		4002	Infant	S0450L-L		S0450L-LP				
		4003	Neonate/ Adult	S0450M-L		S0450M-LP	S0450N-L			









## Disposable SpO2 Sensors (Old Sensor Appearance)

OEM Manufacturer & Models	Instrument Connector	OEM #	Patient Size	Microfoam (Adhesive Sensor)	Non-woven Fabric Adhesive	Elastic Fabric Adhesive	Comfort Foam Non-Adhesive	Transpore Adhesive	Price	Sensor Picture
<b>Compatible Nihon Kohden</b>										
Bedside Monitor: BSM-4101, 4103, 4111, 4113 Life scope P, BSM-5105, 5135 Life scope A, BSM-2351, 2353 Life scope L, BSM-2301, 2303 Life scope I		TL-251T	Adult	S0005J-S	S0005J-SP			S0005J-ST		
		TL-252T	Pediatric	S0005K-S	S0005K-SP			S0005K-ST		
		TL-252T	Infant	S0005L-L		S0005L-LP				
		TL-253T	Neonate/Adult	S0005M-L		S0005M-LP	S0005N-L			
<b>Compatible Nonin</b>										
Nonin: 8500, 8600, 8700, 8800		6000CA/7000A	Adult	S0080J-S	S0080J-SP			S0080J-ST		
		6000CP/7000P	Pediatric	S0080K-S	S0080K-SP			S0080K-ST		
		6000CI/7000I	Infant	S0080L-L		S0080L-LP				
		6000CN/7000N	Neonate/Adult	S0080M-L		S0080M-LP	S0080N-L			
<b>Compatible Nellcor</b>										
Nellcor-Tech OxiSmart		D25	Adult	S0010J-S	S0010J-SP			S0010J-ST		
		D20	Pediatric	S0010K-S	S0010K-SP			S0010K-ST		
		120	Infant	S0010L-L		S0010L-LP				
		N25	Neonate/Adult	S0010M-L		S0010M-LP	S0010N-L			
Nellcor-Tech OxiMax		MAX-A	Adult	S0026J-S	S0026J-SP			S0026J-ST		
		MAX-P	Pediatric	S0026K-S	S0026K-SP			S0026K-ST		
		MAX-I	Infant	S0026L-L		S0026L-LP				
		MAX-N	Neonate/Adult	S0026M-L		S0026M-LP	S0026N-L			







## Disposable SpO2 Sensors (Old Sensor Appearance)

OEM Manufacturer & Models	Instrument Connector	OEM #	Patient Size	Microfoam (Adhesive Sensor)	Non-woven Fabric Adhesive	Elastic Fabric Adhesive	Comfort Foam Non-Adhesive	Transpore Adhesive	Price	Sensor Picture
<b>Compatible Philips</b>										
M3, M4, MP20, MP30, MP40, MP50, MP70, MP80, VM4, VM6, VM8			Adult	S0015J-S	S0015J-SP			S0015J-ST		
			Pediatric	S0015K-S	S0015K-SP			S0015K-ST		
			Infant	S0015L-L		S0015L-LP				
			Neonate/Adult	S0015M-L		S0015M-LP	S0015N-L			
<b>Compatible GE</b>										
GE-TruSignal+ (GE B650)			Adult	S0190J-S	S0190J-SP			S0190J-ST		
			Pediatric	S0190K-S	S0190K-SP			S0190K-ST		
			Infant	S0190L-L		S0190L-LP				
			Neonate/Adult	S0190M-L		S0190M-LP	S0190N-L			
GE-Datex Ohmeda (GE-OxyTip+, 3740, 3710, only use for Ohmeda oximeter, EMITTER: 660/905/940-4)		OXY-AP	Adult	S0123J-S	S0123J-SP			S0123J-ST		
			Pediatric	S0123K-S	S0123K-SP			S0123K-ST		
			Infant	S0123L-L		S0123L-LP				
		OXY-AF	Neonate/Adult	S0123M-L		S0123M-LP	S0123N-L			
<b>Compatible Comen (China)</b>										
Comen C70 C30			Adult	S0542J-S	S0542J-SP			S0542J-ST		
			Pediatric	S0542K-S	S0542K-SP			S0542K-ST		
			Infant	S0542L-L		S0542L-LP				
			Neonate/Adult	S0542M-L		S0542M-LP	S0542N-L			









## Disposable SpO2 Sensors (Old Sensor Appearance)

OEM Manufacturer & Models	Instrument Connector	OEM #	Patient Size	Microfoam (Adhesive Sensor)	Non-woven Fabric Adhesive	Elastic Fabric Adhesive	Comfort Foam Non-Adhesive	Transpore Adhesive	Price	Sensor Picture
<b>Compatible Biolight (China)</b>										
A Series; Q Series S Series After 2019 encryption (Digital Tech)			Adult	S0515J-S	S0515J-SP			S0515J-ST		
			Pediatric	S0515K-S	S0515K-SP			S0515K-ST		
			Infant	S0515L-L		S0515L-LP				
			Neonate/Adult	S0515M-L		S0515M-LP	S0515N-L			
A Series; Q Series M Series Before 2018 (Digital Tech, open system)			Adult	S0165J-S	S0165J-SP			S0165J-ST		  
			Pediatric	S0165K-S	S0165K-SP			S0165K-ST		
			Infant	S0165L-L		S0165L-LP				
			Neonate/Adult	S0165M-L		S0165M-LP	S0165N-L			
<b>Compatible Medlinket</b>										
AM805, 806			Adult	S0557J-S	S0557J-SP			S0557J-ST		
			Pediatric	S0557K-S	S0557K-SP			S0557K-ST		
			Infant	S0557L-L		S0557L-LP				
			Neonate/Adult	S0557M-L		S0557M-LP	S0557N-L			
Multi-compatible			Adult	S0163J-S	S0163J-SP			S0163J-ST		
			Pediatric	S0163K-S	S0163K-SP			S0163K-ST		
			Infant	S0163L-L		S0163L-LP				
			Neonate/Adult	S0163M-L		S0163M-LP	S0163N-L			





## Disposable Forehead SpO2 Sensors

OEM Manufacturer & Models	Photo	OEM #	Patient Size	Order Code	Descriptions	Price
<b>Compatible Masimo Tech</b>						
Masimo Oximeter and all patient monitors with Masimo RD set module, such as Philips, Mindray, GE, etc		RD SET TFA-1	Pediatric (>10 kg) /Adult	S0020T-L	8PIN, Microfoam(Adhesive),Adult,0.9m	
<b>Compatible Masimo LNCS</b>						
Masimo Oximeter and all patient monitors with Masimo RD set module, such as Philips, Mindray, GE, etc		M-LNCS TFA-1	Pediatric (>10 kg) /Adult	S0442T-L	9PIN, Microfoam(Adhesive),Adult,0.9m	
<b>Compatible Masimo LNCS(open system)</b>						
Masimo Oximeter and all patient monitors with Masimo RD set module, such as Philips, Mindray, GE, etc		M-LNCS TFA-1	Pediatric (>10 kg) /Adult	S0204T-L	9PIN, Microfoam(Adhesive),Adult,0.9m	
<b>Compatible Masimo M-tech</b>						
Masimo Oximeter and all patient monitors with Masimo RD set module, such as Philips, Mindray, GE, etc			Pediatric (>10 kg) /Adult	S0540T-L	15PIN, Microfoam (Adhesive),Adult,0.9m	
<b>Compatible Masimo RD</b>						
Masimo Oximeter and all patient monitors with Masimo RD set module, such as Philips, Mindray, GE, etc		RD SET TF-I	Pediatric (>10 kg) /Adult	S0450T-L	11PIN, Microfoam(Adhesive),0.9m	
<b>Compatible Nihon Kohden</b>						
Masimo Oximeter and all patient monitors with Masimo RD set module, such as Philips, Mindray, GE, etc			Pediatric (>10 kg) /Adult	S0005T-L	9PIN, Microfoam(Adhesive),Adult,0.9m	
<b>Compatible Nonin</b>						
Nonin oximeter and patient monitors.		8000R (Reusable)	Pediatric (>10 kg) /Adult	S0080T-L	9PIN, Microfoam(Adhesive),Adult,0.9m	

## Disposable Forehead SpO2 Sensors

OEM Manufacturer & Models	Photo	OEM #	Patient Size	Order Code	Descriptions	Price
<b>Compatible Mindray (Nellcor OxiSmart)</b>						
Nellcor Oximeter and all patient monitors with Nellcor OxiSmart module, such as Philips,			Pediatric (>10 kg) /Adult	S0010T-L	7PIN, Microfoam(Adhesive),0.9m	
<b>Compatible Nellcor Oximax</b>						
Nellcor Oximeter and all patient monitors with Nellcor Oximax module, such as Philips, Mindray, GE,		MAXFAST	Pediatric (>10 kg) /Adult	S0026T-L	9PIN, Microfoam(Adhesive),Adult,0.9m	
<b>Compatible Philips</b>						
M3, M4, MP20, MP30, MP40, MP50, MP70, MP80, VM4, VM6, VM8			Pediatric (>10 kg) /Adult	S0015T-L	8PIN, Microfoam(Adhesive),Adult,0.9m	
<b>Compatible GE-TruSignal+</b>						
GE B650			Pediatric (>10 kg) /Adult	S0190T-L	9PIN, Microfoam(Adhesive),Adult,0.9m	
<b>Compatible GE-OxyTip+</b>						
3740, 3710, only use for Ohmeda oximeter, EMITTER: 660/905/940-4			Pediatric (>10 kg) /Adult	S0123T-L	8PIN, Microfoam(Adhesive),Adult,0.9m	
<b>Compatible Comen (China)</b>						
Comen C70 C30			Pediatric (>10 kg) /Adult	S0542T-L	7PIN, Microfoam(Adhesive),Adult,0.9m	
<b>Compatible Biolight (China)</b>						
A Series; Q Series S Series After 2019 encryption (Digital Tech)			Pediatric (>10 kg) /Adult	S0515T-L	9PIN, Microfoam(Adhesive),Adult,0.9m	
A Series; Q Series M Series Before 2018 (Digital Tech, open system)			Pediatric (>10 kg) /Adult	S0165T-L	7PIN, Microfoam(Adhesive),Adult,0.9m	

## Disposable Forehead SpO2 Sensors

OEM Manufacturer & Models	Photo	OEM #	Patient Size	Order Code	Descriptions	Price
<b>Compatible Medlinket</b>						
AM805, 806(TYEP C)			Pediatric (>10 kg) /Adult	S0557T-L	24PIN, Microfoam (Adhesive), Adult, 0.9m	
Multi-compatible			Pediatric (>10 kg) /Adult	S0163T-L	9PIN, Microfoam (Adhesive), Adult, 0.9m	
<b>SpO2 Accessories</b>						
Order Code	Photo	Product Name	Purpose of Use	Package	Price	
BZ0042K		Disposable 3M adhesive textile tape For adult and neonate	Used with NE tech D-YS or Medlinket SpO2 sensors or Other brands SpO2 sensors	50PCS/Bag		
SL0004C		Ear sensor hanger	Used with Medlinket ear clip sensors or other brands SpO2 sensors	1pcs/Bag		
HL0276C		Reusable foam tape For all patient sizes	Used with NE tech D-YS or Medlinket S0010/S0026 series sensors	50PCS/Bag		
SL0466A		Adult ear clip or as animal Small size lingua clip	Used with NE tech D-YS or Medlinket SpO2 sensors	1pcs/Bag		
SL0467A		Animal lingua clip, middle size				

**\*Disclaimer:**

All the registered trademarks, product names, models, etc. shown in the catalogue are owned by the original holder or the original manufacturer. This article is only used to explain the compatibility of the MEDLINKET products, and nothing else! All the above information is for reference only, and should not be used as a working guide for medical institutions or related units. Otherwise, any consequences will be irrelevant to the company.

Shenzhen Med-link Electronics Tech Co., Ltd

Address: Zone A of 1st and 2nd Floor, and 3rd Floor, Building A, No. 7, Tongsheng Industrial Park Road, Shanghenglang Community, Dalang Street, Longhua District, 518109 Shenzhen, PEOPLE'S REPUBLIC OF CHINA

Tel: 86-0755-61120085 Fax: 86-0755-61120055

E-mail: marketing@med-linket.com

Website: www.med-linket.com



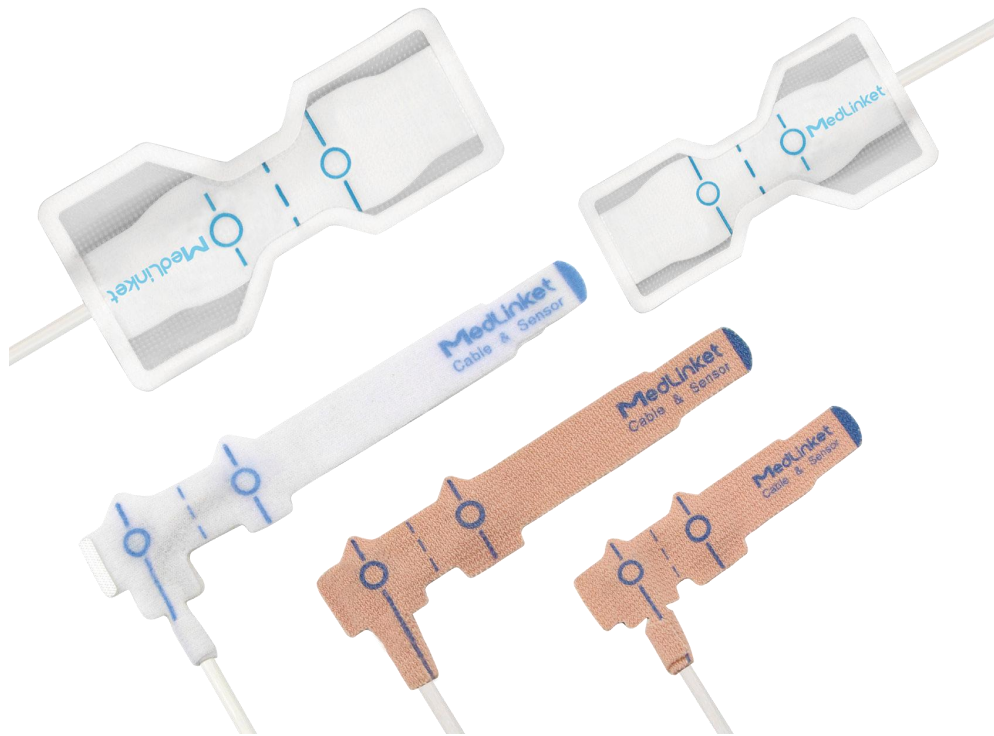

## 2 Multi-compatible Disposable SpO2 Sensors

Supplied a most range of SpO2 adapters, covering most patient monitors (such as Philips, GE, Drager, Mindray, Nihon Kohden, etc) in hospital departments. Connect the SpO2 adapters with SpO2 extension cable, to achieve one kind of SpO2 probe that can be compatible with most monitors in the hospital, reducing costs and improving efficiency.



### Time cost

Reduced workload by eliminating the need for staff matching;



### Inventory management

Single product, no need to consider the different models of compatible probes ought to be equipped with stock matters;



### Cost saving









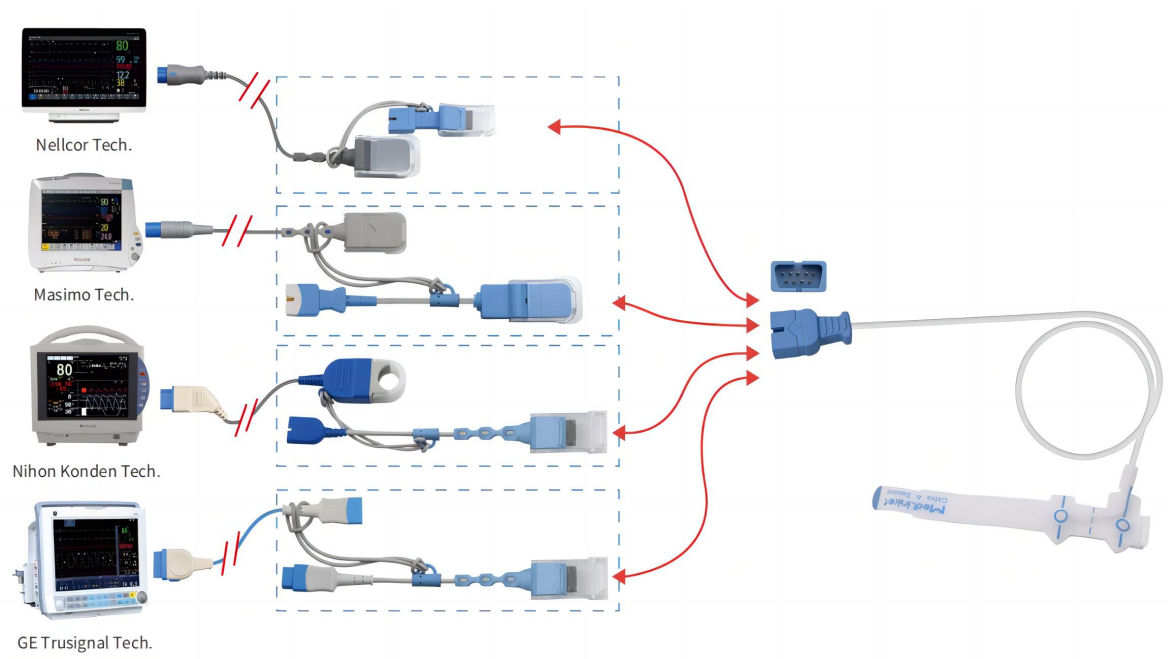

Single product, only consider the overall use for stock, no need to split compatible models;

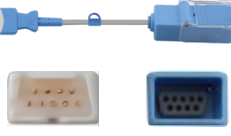

### Stock plan

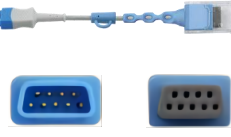
The SpO2 probe enables the compatibility of monitors with different SpO2 module technologies when occur inside and outside the patient transfer unit and operating theatre, it's save patient costs and enhancing the patient experience.

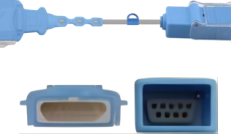

Adapters			Disposable SpO2 Sensors			Pice
Product Picture	Order Code	Descriptions	Product Picture	Order Code	Descriptions	
	S0026MU-A	DB9 female to male, 65mm		603481632	Adult, Pediatric, Infant, Neonatal, Comfort Foam (Non-Adhesive Sensor) 9pin, 0.9m	
	S0005MU-A	DB9 female to male, 0.2m		603471632	Adult, Pediatric, Infant, Neonatal, Elastic Fabric (Adhesive Sensor) 9pin, 0.9m	
	S0442MU-A	DB9 female to male, 0.2m		603371632	Infant, Elastic Fabric (Adhesive Sensor) 9pin, 0.9m	
	S0190MU-A	DB9 female to male, 0.2m		603261631	Pediatric, Transpore (Adhesive Sensor) 9pin, 0.9m	
	S0540MU-A	Masimo 15pin to DB9F, 0.15m		603161631	Adult, Transpore (Adhesive Sensor) 9pin, 0.9m	

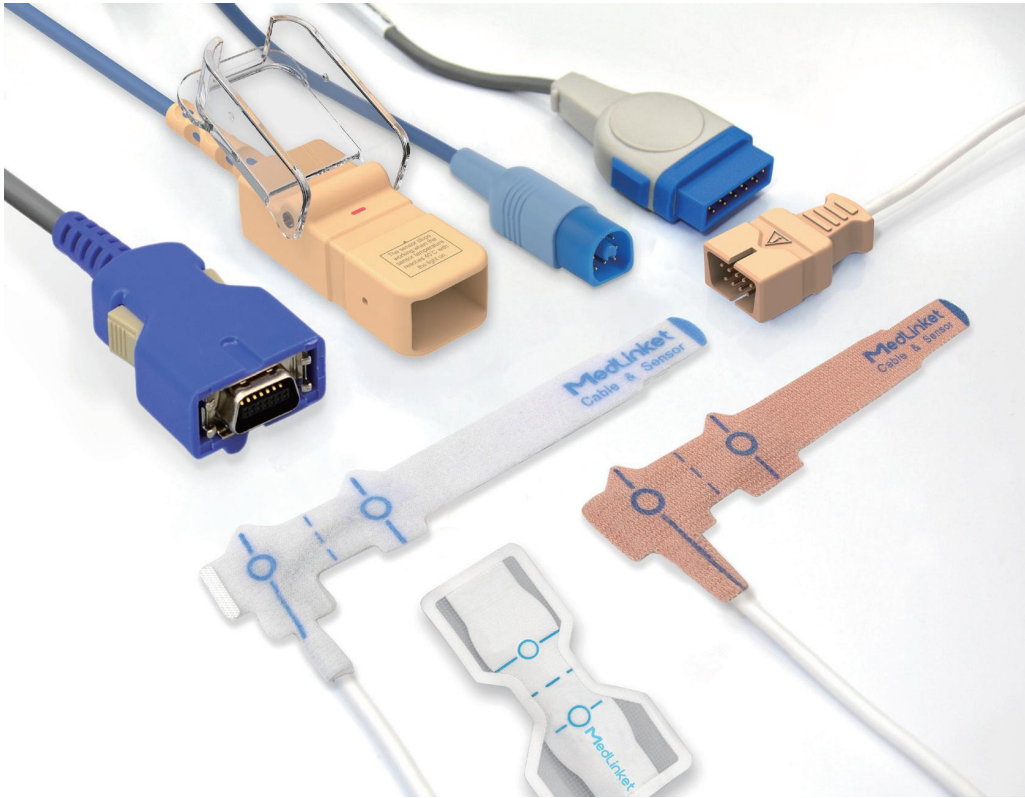

## 3 Over-temp. Protection SpO2 Sensors

### Product Features

1. Over-temperature monitoring: there is a temperature sensor at the probe end. After matching with a dedicated adapter cable and monitor, it has a partial over-temperature monitoring function, reducing the risk of burns and reducing the burden of regular inspections by medical personnel;
2. More comfortable: the smaller space of the probe wrapping part and good air permeability;
3. Efficient and convenient: v-shaped probe design, quick positioning of the monitoring position; connector handle design, easier connection;
4. Safety guarantee: good biocompatibility, no latex;
5. High accuracy: evaluation of SpO2 accuracy by comparing arterial blood gas analyzers;
6. Good compatibility: it can be adapted to mainstream brand monitors, such as Philips, GE, Mindray, etc;
7. Clean, safe and hygienic: production and packaging in the clean workshop to avoid cross-infection.

### Scope of Application

1. Operating Room (OR)
2. ICU
3. Neonatology
4. Internal Cardiovascular Dept.
5. Cardiothoracic Surgery Dept.

## Use Icons and Instructions

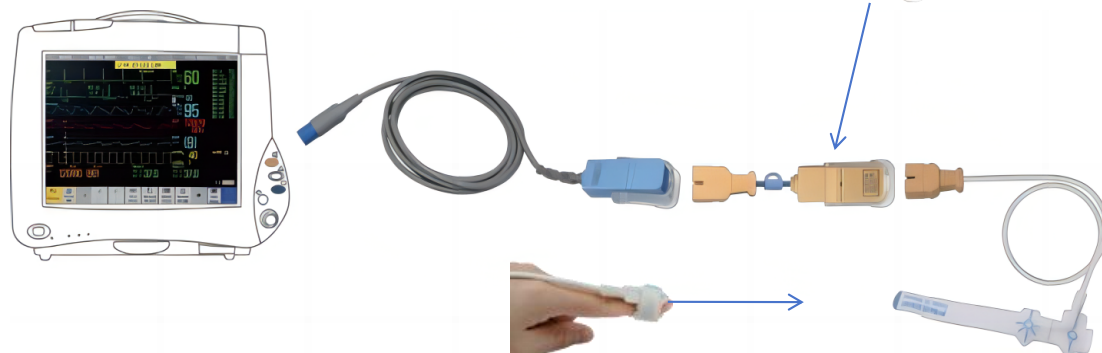

The SpO2 sensor is equipped with a temperature sensor. After being matched with dedicated adapter cable and monitor, it has a partial over-temperature monitoring function, which reduces the risk of burns and reduces the burden of regular inspections by medical personnel.

The following conditions may be at risk of skin burns:

- 1) The patient's measurement site has weak perfusion and cannot take away the sensor temperature through normal blood circulation;
- 2) The measurement site is too thick; (for example, the foot of newborns whose weight are more than 3.5KG are too thick and should not be wrapped for measurement)
- 3) Failure to regularly check the sensor and change the position.

1. Please read the instructions carefully before use, and use the product according to the instructions;

2. When the skin temperature of the patient's monitoring site exceeds 41°C, the sensor will stop working immediately. At the same time, the indicator light of the SpO2 sensor adapter cable emits a red light, and the monitor emits an alarm sound, which prompts medical personnel to take timely measures to avoid burns;





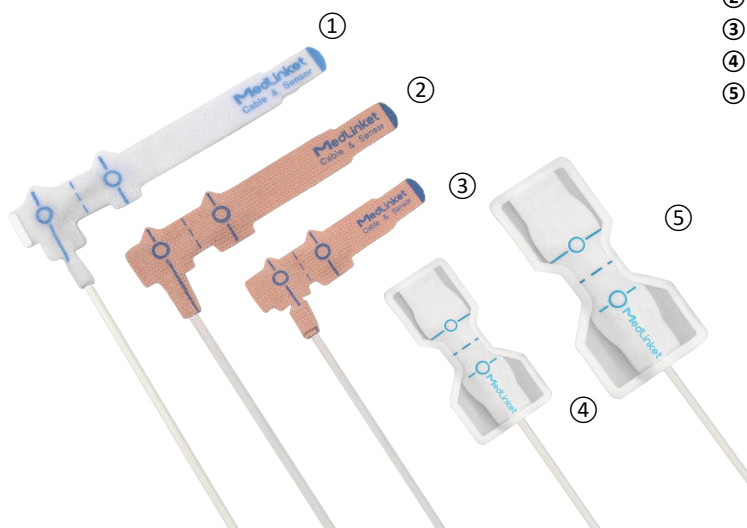

3. When the skin temperature drops below 41°C, the sensor will restart to monitor SpO2.

## Sensor Categories

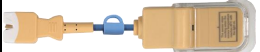

- ① Comfort Foam (Non-Adhesive)
- ② Elastic Fabric (Adhesive)
- ③ Elastic Fabric (Adhesive)
- ④ Transpore (Adhesive)
- ⑤ Transpore (Adhesive)

## Over-temp. Protection SpO2 Sensors

Adapters			Disposable SpO2 Sensors			Pice
Product Picture	Order Code	Descriptions	Product Picture	Order Code	Descriptions	
	S0026OP-A	9pin to 9pin, 0.15m		604480102 (EU) 504480102 (US)	Adult, Pediatric, Infant, Neonatal, Comfort Foam (Non-Adhesive Sensor) 9pin, 0.9m	
				604470102 (EU) 504470102 (US)	Adult, Pediatric, Infant, Neonatal, Elastic Fabric (Adhesive Sensor) 9pin, 0.9m	
	S0442OP-A	9pin to 9pin, 0.2m		604370102 (EU) 504370102 (US)	Infant, Elastic Fabric (Adhesive Sensor) 9pin, 0.9m	
				604260101 (EU) 504260101 (US)	Pediatric, Transpore (Adhesive Sensor) 9pin, 0.9m	
				604160101 (EU) 504160101 (US)	Adult, Transpore (Adhesive Sensor) 9pin, 0.9m	



## 4 Reusable SpO2 Sensors

### Code Rule Description

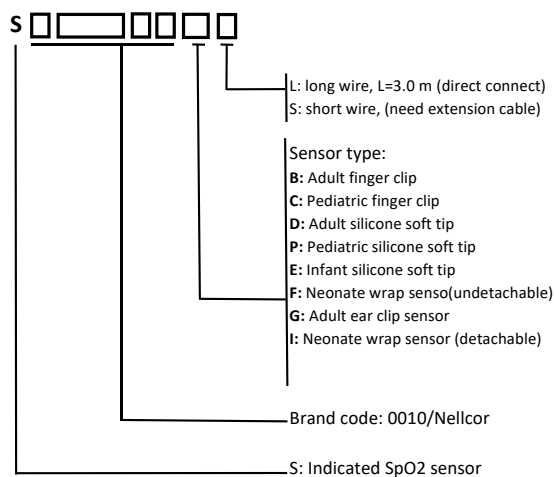



### Product Features











1. High SpO2 Accuracy: Passed the clinical accuracy verification of American clinical laboratory, the First Affiliated Hospital of Sun Yat-sen University, and Yuebei People's Hospital.
2. Compatible with Nellcor, Masimo, Philips, GE, Drager, Nihon Kohden, Mindray, Spacelabs, Nonin, etc.
3. Suitable for adults, Pediatric, Infant, Neonatal, and also other skin color people as well as veterinary.
4. Well anti-electromagnetic interference, suitable for complex electrical environment.
5. Anti-dust design, TPU cable, injection molding process(plugs, strain relief), durable and comfortable.
6. Biocompatibility passed, avoiding allergic reactions to patient.
7. Latex free.

OEM Manufacturer & Models	Instrument Connector	OEM#	Old Order Code	New Order Code	Descriptions	Adapter Cable	Price
<b>Compatible Anke (China)</b>							
ASC-553			S0007B-L	635170074	Adult Finger Clip, 10ft(3m)	/	C0
			S0007C-L	635210074	Pediatric Finger Clip, 10ft(3m)		D2
			S0007D-L	635120074	Adult Silicone Soft, 10ft(3m)		D2
			S0007P-L	635220074	Pediatric Silicone Soft, 10ft(3m)		D2
			S0007F-L	635430074	Neonate Silicone Wrap, 10ft(3m)		D2
			S0007I-L	635190074	Multi-site Y, 10ft(3m)		D2
			S0007G-L	635140074	Adult Ear Clip, 10ft(3m)		D2
ASC-554			S0003B-L	635170034	Adult Finger Clip, 10ft(3m)	/	C0
			S0003C-L	635210034	Pediatric Finger Clip, 10ft(3m)		D2
			S0003D-L	635120034	Adult Silicone Soft, 10ft(3m)		D2
			S0003P-L	635220034	Pediatric Silicone Soft, 10ft(3m)		D2
			S0003F-L	635430034	Neonate Silicone Wrap, 10ft(3m)		D2
			S0003I-L	635190034	Multi-site Y, 10ft(3m)		D2
			S0003G-L	635140034	Adult Ear Clip, 10ft(3m)		D2
<b>Compatible Artema/S&amp;W</b>							
Diascope 8000, Athena		SL033057	S0023B-L	635170234	Adult Finger Clip, 10ft(3m)	/	D0
			S0023C-L	635210234	Pediatric Finger Clip, 10ft(3m)		D2
			S0023D-L	635120234	Adult Silicone Soft, 10ft(3m)		D2
			S0023P-L	635220234	Pediatric Silicone Soft, 10ft(3m)		D2
			S0023F-L	635430234	Neonate Silicone Wrap, 10ft(3m)		D2
			S0023I-L	635190234	Multi-site Y, 10ft(3m)		D2
			S0023G-L	635140234	Adult Ear Clip, 10ft(3m)		D2
Diascope 8000			S0156B-L	635171564	Adult Finger Clip, 10ft(3m)	/	D0
			S0156C-L	635211564	Pediatric Finger Clip, 10ft(3m)		D2
			S0156D-L	635121564	Adult Silicone Soft, 10ft(3m)		D2
			S0156P-L	635221564	Pediatric Silicone Soft, 10ft(3m)		D2
			S0156F-L	635431564	Neonate Silicone Wrap, 10ft(3m)		D2
			S0156I-L	635191564	Multi-site Y, 10ft(3m)		D2
			S0156G-L	635141564	Adult Ear Clip, 10ft(3m)		D2
<b>Compatible AURORA</b>							
AURORA 12 Aurora 12s, Aurora 8, Aurora 10				635175814	Adult Finger Clip, 10ft(3m)	/	D0
				635215814	Pediatric Finger Clip, 10ft(3m)		D2
				635125814	Adult Silicone Soft, 10ft(3m)		D2
				635225814	Pediatric Silicone Soft, 10ft(3m)		D2
				635435814	Neonate Silicone Wrap, 10ft(3m)		D2
				635195814	Multi-site Y, 10ft(3m)		D2
				635145814	Adult Ear Clip, 10ft(3m)		D2









OEM Manufacturer & Models	Instrument Connector	OEM#	Old Order Code	New Order Code	Descriptions	Adapter Cable	Price
<b>Compatible BCI</b>							
3401, 3304, 3303, 3302, 3301, 3300; Spacelabs Burdick: PRO2; Drager: Drager Oxipac 2000 ChoiceMMed:MD300A ,MMED6000DP-M7, MMED 6000DP-SF		3044	S0076B-L	635170764	Adult Finger Clip,10ft(3m)	/	C0
		3178	S0076C-L	635210764	Pediatric Finger Clip,10ft(3m)		D2
			S0076D-1	635120764	Adult Silicone Soft,10ft(3m)		D2
			S0076P-L	635220764	Pediatric Silicone Soft,10ft(3m)		D2
			S0076E-L	635320764	Infant Silicone Soft, 10ft(3m)		D2
			S0076F-I	635430764	Neonate Silicone Wrap, 10ft(3m)		D2
			S0076I-L	635190764	Multi-site Y, 10ft(3m)		D2
			S0076G-L	635140764	Adult Ear Clip, 10ft(3m)		D2
3300 3301 3302 3303 3304 3401		3044	S0076B-S	635170762	Adult Finger Clip,3ft(0.9m)	Need S0076BC-L Instrument Connector:  Sensor Connector: 	C2
		3178	S0076C-S	635210762	Pediatric Finger Clip,3ft(0.9m)		C4
		3044	S0076D-S	635120762	Adult Silicone Soft,3ft(0.9m)		C4
			S0076P-S	635220762	Pediatric Silicone Soft,3ft(0.9m)		C4
		3178	S0076E-S	635320762	Infant Silicone Soft, 3ft(0.9m)		C4
			S0076F-S	635430762	Neonate Silicone Wrap, 3ft(0.9m)		C4
			S0076I-S	635190766	Multi-site Y, 4ft(1.2m)		C4
			S0076G-S	635140762	Adult Ear Clip, 3ft(0.9m)		C4
3300,3301, 6100,9100, Advisor, Autocorr MiniToor, Mini Torr Plus			S0111B-L	635171114	Adult Finger Clip,10ft(3m)	/	C0
			S0111C-L	635211114	Pediatric Finger Clip,10ft(3m)		D2
			S0111D-L	635121114	Adult Silicone Soft,10ft(3m)		D2
			S0111P-L	635221114	Pediatric Silicone Soft,10ft(3m)		D2
			S0111F-L	635431114	Neonate Silicone Wrap, 10ft(3m)		D2
			S0111I-L	635191114	Multi-site Y, 10ft(3m)		D2
			S0111G-L	635141114	Adult Ear Clip, 10ft(3m)		D2
<b>Compatible Biosys</b>							
BPM-200, SENTRY (OxiSmart Tech)			S0010B-S	635170102	Adult Finger Clip,3ft(0.9m)	Need S0010NE-L Instrument Connector:  Sensor Connector: 	B5
			S0010C-S	635210102	Pediatric Finger Clip,3ft(0.9m)		C4
			S0010D-S	635120102	Adult Silicone Soft,3ft(0.9m)		C4
			S0010P-S	635220102	Pediatric Silicone Soft,3ft(0.9m)		C4
			S0010F-S	635430102	Neonate Silicone Wrap, 3ft(0.9m)		C4
			S0010I-S	635190106	Multi-site Y, 4ft(1.2m)		C4
			S0010G-S	635140102	Adult Ear Clip, 3ft(0.9m)		C4

OEM Manufacturer & Models	Instrument Connector	OEM#	Old Order Code	New Order Code	Descriptions	Adapter Cable	Price
<b>Compatible Biocare (China)</b>							
BP-12B BP-12C (Digital tech)			S0160B-L	635171604	Adult Finger Clip, 10ft(3m)	/	C0
			S0160C-L	635211604	Pediatric Finger Clip, 10ft(3m)		D2
			S0160D-L	635121604	Adult Silicone Soft, 10ft(3m)		D2
			S0160P-L	635221604	Pediatric Silicone Soft, 10ft(3m)		D2
			S0160F-L	635431604	Neonate Silicone Wrap, 10ft(3m)		D2
			S0160I-L	635191604	Multi-site Y, 10ft(3m)		D2
			S0160G-L	635141604	Adult Ear Clip, 10ft(3m)		D2
BM-9000			S0040B-L	635170404	Adult Finger Clip, 10ft(3m)	/	C0
			S0040C-L	635210404	Pediatric Finger Clip, 10ft(3m)		D2
			S0040D-L	635120404	Adult Silicone Soft, 10ft(3m)		D2
			S0040P-L	635220404	Pediatric Silicone Soft, 10ft(3m)		D2
			S0040F-L	635430404	Neonate Silicone Wrap, 10ft(3m)		D2
			S0040I-L	635190404	Multi-site Y, 10ft(3m)		D2
			S0040G-L	635140404	Adult Ear Clip, 10ft(3m)		D2
Biocare M8, IM10, IM12				635175754	Adult Finger Clip, 10ft(3m)	/	C0
				635215754	Pediatric Finger Clip, 10ft(3m)		D2
				635125754	Adult Silicone Soft, 10ft(3m)		D2
				635225754	Pediatric Silicone Soft, 10ft(3m)		D2
				635435754	Neonate Silicone Wrap, 10ft(3m)		D2
				635195754	Multi-site Y, 10ft(3m)		D2
				635145754	Adult Ear Clip, 10ft(3m)		D2
<b>Compatible Baxter/Simed</b>							
ASAT, S-50/100/ 100a			S0023B-L	635170234	Adult Finger Clip, 10ft(3m)	/	C2
			S0023C-L	635210234	Pediatric Finger Clip, 10ft(3m)		D2
			S0023D-L	635120234	Adult Silicone Soft, 10ft(3m)		D2
			S0023P-L	635220234	Pediatric Silicone Soft, 10ft(3m)		D2
			S0023F-L	635430234	Neonate Silicone Wrap, 10ft(3m)		D2
			S0023I-L	635190234	Multi-site Y, 10ft(3m)		D2
			S0023G-L	635140234	Adult Ear Clip, 10ft(3m)		D2
Explorer, Monarch (Oximax Tech)		DS100A	S0026B-S	635170262	Adult Finger Clip, 3ft(0.9m)	Need S0026OX-L Instrument Connector:  Sensor Connector: 	C2
			S0026C-S	635210262	Pediatric Finger Clip, 3ft(0.9m)		C2
			S0026D-S	635120262	Adult Silicone Soft, 3ft(0.9m)		D5
			S0026P-S	635220262	Pediatric Silicone Soft, 3ft(0.9m)		D5
			S0026F-S	635430262	Neonate Silicone Wrap, 3ft(0.9m)		D5
		D-YS	S0026I-S	635190266	Multi-site Y, 4ft(1.2m)		D5
			S0026G-S	635140262	Adult Ear Clip, 3ft(0.9m)		D5

OEM Manufacturer & Models	Instrument Connector	OEM#	Old Order Code	New Order Code	Descriptions	AdapterCabl	Price
<b>Compatible Bionet (Korea)</b>							
BM3/BM5 (New)			S0121B-L	635171214	Adult Finger Clip, 10ft(3m)	/	C0
			S0121C-L	635211214	Pediatric Finger Clip, 10ft(3m)		C0
			S0121D-L	635121214	Adult Silicone Soft, 10ft(3m)		D2
			S0121P-L	635221214	Pediatric Silicone Soft, 10ft(3m)		D2
			S0121F-L	635431214	Neonate Silicone Wrap, 10ft(3m)		D2
			S0121I-L	635191214	Multi-site Y, 10ft(3m)		D2
			S0121G-L	635141214	Adult Ear Clip, 10ft(3m)		D2
BM3			S0084B-L	635170844	Adult Finger Clip, 10ft(3m)	/	C0
			S0084C-L	635210844	Pediatric Finger Clip, 10ft(3m)		C0
			S0084D-L	635120844	Adult Silicone Soft, 10ft(3m)		D2
			S0084P-L	635220844	Pediatric Silicone Soft, 10ft(3m)		D2
			S0084F-L	635430844	Neonate Silicone Wrap, 10ft(3m)		D2
			S0084I-L	635190844	Multi-site Y, 10ft(3m)		D2
			S0084G-L	635140844	Adult Ear Clip, 10ft(3m)		D2
BM3, BM3 Plus (OxiSmart Tech)			S0010B-S	635170102	Adult Finger Clip, 3ft(0.9m)	Need S0084BC-L Instrument Connector:  Sensor Connector: 	B5
			S0010C-S	635210102	Pediatric Finger Clip, 3ft(0.9m)		C4
			S0010D-S	635120102	Adult Silicone Soft, 3ft(0.9m)		C4
			S0010P-S	635220102	Pediatric Silicone Soft, 3ft(0.9m)		C4
			S0010F-S	635430102	Neonate Silicone Wrap, 3ft(0.9m)		C4
			S0010I-S	635190106	Multi-site Y, 4ft(1.2m)		C4
			S0010G-S	635140102	Adult Ear Clip, 3ft(0.9m)		C4
<b>Compatible Bruker (Odam)</b>							
Bruker(Odam) all, as DC-3002, IH, M3			S0071B-L	635170714	Adult Finger Clip, 10ft(3m)	/	C0
			S0071C-L	635210714	Pediatric Finger Clip, 10ft(3m)		D2
			S0071D-L	635120714	Adult Silicone Soft, 10ft(3m)		D2
			S0071P-L	635220714	Pediatric Silicone Soft, 10ft(3m)		D2
			S0071F-L	635430714	Neonate Silicone Wrap, 10ft(3m)		D2
			S0071I-L	635190714	Multi-site Y, 10ft(3m)		D2
			S0071G-L	635140714	Adult Ear Clip, 10ft(3m)		D2
<b>Compatible Biolight (China)</b>							
M900, M7000, M9500 A8 (Digital Tech)			S0419B-L	635174194	Adult Finger Clip, 10ft(3m)	/	C0
			S0419C-L	635214194	Pediatric Finger Clip, 10ft(3m)		D2
			S0419D-L	635124194	Adult Silicone Soft, 10ft(3m)		D2
			S0419P-L	635224194	Pediatric Silicone Soft, 10ft(3m)		D2
			S0419F-L	635434194	Neonate Silicone Wrap, 10ft(3m)		D2
			S0419I-L	635194194	Multi-site Y, 10ft(3m)		D2
			S0419G-L	635144194	Adult Ear Clip, 10ft(3m)		D2







OEM Manufacturer & Models	Instrument Connector	OEM#	Old Order Code	New Order Code	Descriptions	Adapter Cable	Price
<b>Compatible Biolight (China)</b>							
M6, M12, M69 (Analog Tech)			S0029B-L	635170294	Adult Finger Clip, 10ft(3m)	/	C0
			S0029C-L	635210294	Pediatric Finger Clip, 10ft(3m)		D2
			S0029D-L	635120294	Adult Silicone Soft, 10ft(3m)		D2
			S0029P-L	635220294	Pediatric Silicone Soft, 10ft(3m)		D2
			S0029F-L	635430294	Neonate Silicone Wrap, 10ft(3m)		D2
			S0029I-L	635190294	Multi-site Y, 10ft(3m)		D2
			S0029G-L	635140294	Adult Ear Clip, 10ft(3m)		D2
M12, M6, M66, M69, M8000, M9000 (Digital Tech)			S0155B-L	635171554	Adult Finger Clip, 10ft(3m)	/	C0
			S0155C-L	635211554	Pediatric Finger Clip, 10ft(3m)		D2
			S0155D-L	635121554	Adult Silicone Soft, 10ft(3m)		D2
			S0155P-L	635221554	Pediatric Silicone Soft, 10ft(3m)		D2
			S0155F-L	635431554	Neonate Silicone Wrap, 10ft(3m)		D2
			S0155I-L	635191554	Multi-site Y, 10ft(3m)		D2
			S0155G-L	635141554	Adult Ear Clip, 10ft(3m)		D2
			S0404B-S	635174042	Adult Finger Clip, 3ft(0.9m)	Need S0155DO-L Instrument Connector:	C0
			S0404C-S	635214042	Pediatric Finger Clip, 3ft(0.9m)		C0
			S0404D-S	635124042	Adult Silicone Soft, 3ft(0.9m)	D2	
			S0404P-S	635224042	Pediatric Silicone Soft, 3ft(0.9m)	D2	
			S0404F-S	635434042	Neonate Silicone Wrap, 3ft(0.9m)	Sensor Connector: 	D2
			S0404I-S	635194046	Multi-site Y, 4ft(1.2m)	D2	
			S0404G-S	635144042	Adult Ear Clip, 3ft(0.9m)		D2
A Series Q Series (Digital Tech) Before 2018			S0165B-L	635171654	Adult Finger Clip, 10ft(3m)	/	C0
			S0165C-L	635211654	Pediatric Finger Clip, 10ft(3m)		C0
			S0165D-L	635121654	Adult Silicone Soft, 10ft(3m)		D2
			S0165P-L	635221654	Pediatric Silicone Soft, 10ft(3m)		D2
			S0165F-L	635431654	Neonate Silicone Wrap, 10ft(3m)		D2
			S0165I-L	635191654	Multi-site Y, 10ft(3m)		D2
			S0165G-L	635141654	Adult Ear Clip, 10ft(3m)		D2
			S0404B-S	635174042	Adult Finger Clip, 3ft(0.9m)	Need S0165DO-L Instrument Connector:	C0
			S0404C-S	635214042	Pediatric Finger Clip, 3ft(0.9m)		C0
			S0404D-S	635124042	Adult Silicone Soft, 3ft(0.9m)	D2	
			S0404P-S	635224042	Pediatric Silicone Soft, 3ft(0.9m)	D2	
			S0404F-S	635434042	Neonate Silicone Wrap, 3ft(0.9m)	Sensor Connector: 	D2
			S0404I-S	635194046	Multi-site Y, 4ft(1.2m)	D2	
			S0404G-S	635144042	Adult Ear Clip, 3ft(0.9m)		D2

OEM Manufacturer & Models	Instrument Connector	OEM#	Old Order Code	New Order Code	Descriptions	Adapter Cable	Price
<b>Compatible Biolight (China)</b>							
After 2019 encryption (Analog Tech)			S0155B-S	635171552	Adult Finger Clip,3ft(0.9m)	Need S0165DO-L Instrument Connector:	D2
			S0155C-S	635211552	Pediatric Finger Clip,3ft(0.9m)		D2
			S0155D-S	635121552	Adult Silicone Soft,3ft(0.9m)		D3
			S0155P-S	635221552	Pediatric Silicone Soft,3ft(0.9m)	Sensor Connector:	D3
			S0155F-S	635431552	Neonate Silicone Wrap, 3ft(0.9m)		D3
			S0155I-S	635191556	Multi-site Y, 4ft(1.2m)		D3
			S0155G-S	635141552	Adult Ear Clip, 3ft(0.9m)		D3
After 2019 encryption (Digital Tech)		15-100-0013	S0515B-S	635175152	Adult Finger Clip,3ft(0.9m)	/	D2
			S0515C-S	635215152	Pediatric Finger Clip,3ft(0.9m)		D2
			S0515D-S	635125152	Adult Silicone Soft,3ft(0.9m)		D3
			S0515P_S	635225152	Pediatric Silicone Soft,3ft(0.9m)		D3
			S0515F-S	635435152	Neonate Silicone Wrap, 3ft(0.9m)		D3
			S0515I-S	635195156	Multi-site Y, 4ft(1.2m)		D3
			S0515G-S	635145152	Adult Ear Clip, 3ft(0.9m)		D3
A Series Q Series (Digital Tech) After 2019			S0515B-L	635175154	Adult Finger Clip,10ft(3m)	/	D2
			S0515C-L	635215154	Pediatric Finger Clip,10ft(3m)		D2
			S0515D-1	635125154	Adult Silicone Soft,10ft(3m)		D3
			S0515P-L	635225154	Pediatric Silicone Soft,10ft(3m)		D3
			S0515F-L	635435154	Neonate Silicone Wrap, 10ft(3m)		D3
			S0515I-L	635195154	Multi-site Y, 10ft(3m)		D3
			S0515G-L	635145154	Adult Ear Clip, 10ft(3m)		D3
		15-100-0013	S0515B-S	635175152	Adult Finger Clip,3ft(0.9m)	Need S0515DO-L Instrument Connector:	C2
			S0515C-S	635215152	Pediatric Finger Clip,3ft(0.9m)		C2
			S0515D-S	635125152	Adult Silicone Soft,3ft(0.9m)		D3
			S0515P-S	635225152	Pediatric Silicone Soft,3ft(0.9m)	Sensor Connector:	D3
			S0515F-S	635435152	Neonate Silicone Wrap, 3ft(0.9m)		D3
			S0515I-S	635195156	Multi-site Y, 4ft(1.2m)		D3
			S0515G-S	635145152	Adult Ear Clip, 3ft(0.9m)		D3
M6				635175644	Adult Finger Clip,10ft(3m)	/	C2
				635215644	Pediatric Finger Clip,10ft(3m)		C2
				635125644	Adult Silicone Soft,10ft(3m)		D3
				635225644	Pediatric Silicone Soft,10ft(3m)		D3
				635435644	Neonate Silicone Wrap, 10ft(3m)		D3
				635195644	Multi-site Y, 10ft(3m)		D3
				635145644	Adult Ear Clip, 10ft(3m)		D3

OEM Manufacturer & Models	Instrument Connector	OEM#	Old Order Code	New Order Code	Descriptions	Adapter Cable	Price
<b>Compatible Biolight (China)</b>							
Q5, Q7 Qseries				635175744	Adult Finger Clip, 10ft(3m)	/	C2
				635215744	Pediatric Finger Clip, 10ft(3m)		C4
				635125744	Adult Silicone Soft, 10ft(3m)		D5
				635225744	Pediatric Silicone Soft, 10ft(3m)		D5
				635435744	Neonate Silicone Wrap, 10ft(3m)		D5
				635195744	Multi-site Y, 10ft(3m)		D5
				635145744	Adult Ear Clip, 10ft(3m)		D5
A Series Q Series encryption (Analog Tech) After 2019			S0571B-L	635175714	Adult Finger Clip, 10ft(3m)	/	D2
			S0571C-L	635215714	Pediatric Finger Clip, 10ft(3m)		D2
			S0571D-L	635125714	Adult Silicone Soft, 10ft(3m)		D3
			S0571P-L	635225714	Pediatric Silicone Soft, 10ft(3m)		D3
			S0571F-L	635435714	Neonate Silicone Wrap, 10ft(3m)		D3
			S0571I-L	635195714	Multi-site Y, 10ft(3m)		D3
			S0571G-L	635145714	Adult Ear Clip, 10ft(3m)		D3
			S0155B-S	635171552	Adult Finger Clip, 3ft(0.9m)	Need S0165DO-L Instrument Connector:  Sensor Connector: 	D2
			S0155C-S	635211552	Pediatric Finger Clip, 3ft(0.9m)		D2
			S0155D-S	635121552	Adult Silicone Soft, 3ft(0.9m)		D3
			S0155P-S	635221552	Pediatric Silicone Soft, 3ft(0.9m)		D3
			S0155F-S	635431552	Neonate Silicone Wrap, 3ft(0.9m)		D3
			S0155I-S	635191556	Multi-site Y, 4ft(1.2m)		D3
			S0155G-S	635141552	Adult Ear Clip, 3ft(0.9m)		D3
Q5/Q7 After 2018 produce Model (OxiMax Tech)			S0117B-L	635171174	Adult finger clip, 10ft(3m)	/	C2
			S0117C-L	635211174	Pediatric finger clip, 10ft(3m)		C2
			S0117D-L	635121174	Adult silicone soft, 10ft(3m)		D5
			S0117P-L	635221174	Pediatric silicone soft, 10ft(3m)		D5
			S0117F-L	635431174	Neonate silicone wrap, 10ft(3m)		D5
			S0117I-L	635191174	Multi-site Y, 10ft(3m)		D5
			S0117G-L	635141174	Adult ear clip, 10ft(3m)		D5
		DS100A	S0026B-S	635170262	Adult Finger Clip, 3ft(0.9m)	Need S0117OX-L Instrument Connector:  Sensor Connector: 	C2
			S0026C-S	635210262	Pediatric Finger Clip, 3ft(0.9m)		C2
			S0026D-S	635120262	Adult Silicone Soft, 3ft(0.9m)		D5
			S0026P-S	635220262	Pediatric Silicone Soft, 3ft(0.9m)		D5
			S0026F-S	635430262	Neonate Silicone Wrap, 3ft(0.9m)		D5
		D-YS	S0026I-S	635190266	Multi-site Y, 4ft(1.2m)		D5
			S0026G-S	635140262	Adult Ear Clip, 3ft(0.9m)		D5

OEM Manufacturer & Models	Instrument Connector	OEM#	Old Order Code	New Order Code	Descriptions	Adapter Cable	Price	
<b>Compatible Biolight (China)</b>								
Q5/Q7 After 2018 produce Model (Compatible Masimo Tech)		2053	S0442B-L	635174424	Adult Finger Clip,10ft(3m)	/	D0	
			S0442C-L	635214424	Pediatric Finger Clip,10ft(3m)		D0	
			S0442D-L	635124424	Adult Silicone Soft,10ft(3m)		D0	
			S0442P-L	635224424	Pediatric Silicone Soft,10ft(3m)		D0	
			S0442E-L	635324424	Infant Silicone Soft, 10ft(3m)		D0	
			S0442F-L	635434424	Neonate Silicone Wrap, 10ft(3m)		D0	
			S0442I-L	635194424	Multi-site Y, 10ft(3m)		D0	
			S0442G-L	635144424	Adult Ear Clip, 10ft(3m)		D0	
				635184422	Adult Silicone ring type, 3ft (0.9m)		D0	
				S0442B-S	635174422	Adult Finger Clip,3ft(0.9m)	Need S0442CS-L Instrument Connector:	C0
			S0442C-S	635214422	Pediatric Finger Clip,3ft(0.9m)		C0	
			S0442D-S	635124422	Adult Silicone Soft,3ft(0.9m)	C0		
			S0442P-S	635224422	Pediatric Silicone Soft,3ft(0.9m)	Sensor Connector:	C0	
			S0442E-S	635324422	Infant Silicone Soft, 3ft(0.9m)		C0	
			S0442F-S	635434422	Neonate Silicone Wrap, 3ft(0.9m)	C0		
			S0442I-S	635194426	Multi-site Y, 4ft(1.2m)	C0		
	S0442G-S	635144422	Adult Ear Clip, 3ft(0.9m)	C0				
<b>Compatible Charmcare (Korea)</b>								
CX100 (OxiSmart Tech)			S0010B-S	635170102	Adult Finger Clip,3ft(0.9m)	Need S0010NE-L Instrument Connector:	B5	
			S0010C-S	635210102	Pediatric Finger Clip,3ft(0.9m)		C4	
			S0010D-S	635120102	Adult Silicone Soft,3ft(0.9m)	C4		
			S0010P-S	635220102	Pediatric Silicone Soft,3ft(0.9m)	Sensor Connector:	C4	
			S0010F-S	635430102	Neonate Silicone Wrap, 3ft(0.9m)		C4	
			S0010I-S	635190106	Multi-site Y, 4ft(1.2m)	C4		
			S0010G-S	635140102	Adult Ear Clip, 3ft(0.9m)	C4		
<b>Compatible ChoiceMed (China)</b>								
MMED300M MD300K1			S0010B-S	635170102	Adult Finger Clip,3ft(0.9m)	Need S0010NE-L Instrument Connector:	B5	
			S0010C-S	635210102	Pediatric Finger Clip,3ft(0.9m)		C4	
			S0010D-S	635120102	Adult Silicone Soft,3ft(0.9m)	C4		
			S0010P-S	635220102	Pediatric Silicone Soft,3ft(0.9m)	Sensor Connector:	C4	
			S0010F-S	635430102	Neonate Silicone Wrap, 3ft(0.9m)		C4	
			S0010I-S	635190106	Multi-site Y, 4ft(1.2m)	C4		
			S0010G-S	635140102	Adult Ear Clip, 3ft(0.9m)	C4		

OEM Manufacturer & Models	Instrument Connector	OEM#	Old Order Code	New Order Code	Descriptions	Adapter Cable	Price
<b>Compatible ChoiceMed (China)</b>							
MD300A, MD300I, MD300K1, MD300M, MMED6000 DP-M3, MMED6000 DP-M7, MMED6000 DP-S6, MMED6000 DP-SF		3044	S0076B-S	635170762	Adult Finger Clip,3ft(0.9m)	Need S0169NE-L Instrument Connector:	C2
		3178	S0076C-S	635210762	Pediatric Finger Clip,3ft(0.9m)		C4
		3044	S0076D-S	635120762	Adult Silicone Soft,3ft(0.9m)		C4
			S0076P-S	635220762	Pediatric Silicone Soft,3ft(0.9m)		C4
		3178	S0076E-S	635320762	Infant Silicone Soft, 3ft(0.9m)		C4
			S0076F-S	635430762	Neonate Silicone Wrap, 3ft(0.9m)		C4
			S0076I-S	635190766	Multi-site Y, 4ft(1.2m)	C4	
			S0076G-S	635140762	Adult Ear Clip, 3ft(0.9m)	C4	
Mmed 100H, Mmed 300A, Mmed 6000DP (Digital Tech)			S0402B-L	635174024	Adult Finger Clip,10ft(3m)	/	C0
			S0402C-L	635214024	Pediatric Finger Clip,10ft(3m)		D2
			S0402D-L	635124024	Adult Silicone Soft,10ft(3m)		D2
			S0402P-L	635224024	Pediatric Silicone Soft,10ft(3m)		D2
			S0402F-L	635434024	Neonate Silicone Wrap, 10ft(3m)		D2
			S0402I-L	635194024	Multi-site Y, 10ft(3m)		D2
			S0402G-L	635144024	Adult Ear Clip, 10ft(3m)		D2
MMED6000D/D; CSM-2000;Goldway:UT400 0A, UT4000C 4000B; BaoZhong; HongRunDa:EM-6; BIOCARE: BM9000			S0007B-L	635170074	Adult Finger Clip,10ft(3m)	/	C0
			S0007C-L	635210074	Pediatric Finger Clip,10ft(3m)		D2
			S0007D-L	635120074	Adult Silicone Soft,10ft(3m)		D2
			S0007P-L	635220074	Pediatric Silicone Soft,10ft(3m)		D2
			S0007F-L	635430074	Neonate Silicone Wrap, 10ft(3m)		D2
			S0007I-L	635190074	Multi-site Y, 10ft(3m)		D2
			S0007G-L	635140074	Adult Ear Clip, 10ft(3m)		D2
<b>Compatible CAS Medical</b>							
Oscillomate 9002, 9303, 9302S		8000AA	S0080B-L	635170804	Adult Finger Clip,10ft(3m)	/	C0
		8000AP	S0080C-L	635210804	Pediatric Finger Clip,10ft(3m)		D2
		8000AA	S0080D-L	635120804	Adult Silicone Soft,10ft(3m)		D2
			S0080P-L	635220804	Pediatric Silicone Soft,10ft(3m)		D2
		8000AP	S0080E-L	635320804	Infant Silicone Soft, 10ft(3m)		D2
			S0080F-L	635430804	Neonate Silicone Wrap, 10ft(3m)		D2
			S0080I-L	635190804	Multi-site Y, 10ft(3m)		D2
			S0080G-L	635140804	Adult Ear Clip, 10ft(3m)		D2

OEM Manufacturer & Models	Instrument Connector	OEM#	Old Order Code	New Order Code	Descriptions	Adapter Cable	Price
<b>Compatible CAS Medical</b>							
Oscillomate 9002, 9303, 9302S		8000AA,8000A A-2, 8000AA-3, 01-02-0250, 01-03-01170	S0080B-S	635170802	Adult Finger Clip,3ft(0.9m)	Need S0010NE-L Instrument Connector:	C0
		8000AP, 01-03-0121, 01-02-0106	S0080C-S	635210802	Pediatric Finger Clip,3ft(0.9m)		D2
		8000SL	S0080D-S	635120802	Adult Silicone Soft,3ft(0.9m)	Sensor Connector:	D2
		8000SM	S0080P-S	635220802	Pediatric Silicone Soft,3ft(0.9m)		D2
		8000SS	S0080E-S	635320802	Infant Silicone Soft, 3ft(0.9m)		D2
			S0080F-S	635430802	Neonate Silicone Wrap, 3ft(0.9m)		D2
			S0080I-S	635190802	Multi-site Y, 4ft(1.2m)		D2
			S0080G-S	635140802	Adult Ear Clip, 3ft(0.9m)		D2
740-750 (Compatible Masimo tech)		2053	S0442B-L	635174424	Adult Finger Clip,10ft(3m)	/	D0
			S0442C-L	635214424	Pediatric Finger Clip,10ft(3m)		D0
			S0442D-L	635124424	Adult Silicone Soft,10ft(3m)		D0
			S0442P-L	635224424	Pediatric Silicone Soft,10ft(3m)		D0
			S0442E-L	635324424	Infant Silicone Soft, 10ft(3m)		D0
			S0442F-L	635434424	Neonate Silicone Wrap, 10ft(3m)		D0
			S0442I-L	635194424	Multi-site Y, 10ft(3m)		D0
			S0442G-L	635144424	Adult Ear clip, 10ft(3m)		D0
			635184422	Adult Silicone ring type, 3ft (0.9m)	D0		
		S0442B-S	635174422	Adult Finger Clip,3ft(0.9m)	Need S0442CS-L Instrument Connector:	C0	
		S0442C-S	635214422	Pediatric Finger Clip,3ft(0.9m)		C0	
		S0442D-S	635124422	Adult Silicone Soft,3ft(0.9m)	Sensor Connector:	C0	
		S0442P-S	635224422	Pediatric Silicone Soft,3ft(0.9m)		C0	
		S0442E-S	635324422	Infant Silicone Soft, 3ft(0.9m)		C0	
	S0442F-S	635434422	Neonate Silicone Wrap, 3ft(0.9m)		C0		
	S0442I-S	635194426	Multi-site Y, 4ft(1.2m)		C0		
	S0442G-S	635144422	Adult Ear Clip, 3ft(0.9m)		C0		
<b>Compatible Contec (China)</b>							
CMS60C/CW/ D/DW, CMS60, PM50, PM60D, CSM5000, CMS5000C, CMS5100, CMS6000, CMS7000/ 8000/9000 (*Digital Tech)			S0160B-L	635171604	Adult Finger Clip,10ft(3m)	/	C0
			S0160C-L	635211604	Pediatric Finger Clip,10ft(3m)		D2
			S0160D-L	635121604	Adult Silicone Soft,10ft(3m)		D2
			S0160P-L	635221604	Pediatric Silicone Soft,10ft(3m)		D2
			S0160F-L	635431604	Neonate Silicone Wrap, 10ft(3m)		D2
			S0160I-L	635191604	Multi-site Y, 10ft(3m)		D2
			S0160G-L	635141604	Adult Ear Clip, 10ft(3m)		D2

OEM Manufacturer & Models	Instrument Connector	OEM#	Old Order Code	New Order Code	Descriptions	Adapter Cable	Price
<b>Compatible Contec (China)</b>							
CMS60C/CW/ D/DW, CMS60, PM50, PM60D, CSM5000, CMS5000C, CMS5100, CMS6000, CMS7000/ 8000/9000 (*Digital Tech)			S0424B-L	635174244	Adult Finger Clip, 10ft(3m)	/	C2
			S0424C-L	635214244	Pediatric Finger Clip, 10ft(3m)		C0
			S0424D-L	635124244	Adult Silicone Soft, 10ft(3m)		C0
			S0424P-L	635224244	Pediatric Silicone Soft, 10ft(3m)		C0
			S0424F-L	635434244	Neonate Silicone Wrap, 10ft(3m)		C0
			S0424I-L	635194244	Multi-site Y, 10ft(3m)		C0
			S0424G-L	635144244	Adult Ear Clip, 10ft(3m)		C0
Contec: CMS8000, CMS 60C, Biolight: M6, M69			S0155B-L	635171554	Adult Finger Clip, 10ft(3m)	/	C2
			S0155C-L	635211554	Pediatric Finger Clip, 10ft(3m)		C0
			S0155D-L	635121554	Adult Silicone Soft, 10ft(3m)		C0
			S0155P-L	635221554	Pediatric Silicone Soft, 10ft(3m)		C0
			S0155F-L	635431554	Neonate Silicone Wrap, 10ft(3m)		C0
			S0155I-L	635191554	Multi-site Y, 10ft(3m)		C0
			S0155G-L	635141554	Adult Ear Clip, 10ft(3m)		C0
			S0155B-S	635171552	Adult Finger Clip, 3ft(0.9m)	Need S0155NE-L Instrument Connector:	C0
			S0155C-S	635211552	Pediatric Finger Clip, 3ft(0.9m)		D2
			S0155D-S	635121552	Adult Silicone Soft, 3ft(0.9m)		D2
			S0155P-S	635221552	Pediatric Silicone Soft, 3ft(0.9m)		D2
			S0155F-S	635431552	Neonate Silicone Wrap, 3ft(0.9m)		D2
			S0155I-S	635191556	Multi-site Y, 4ft(1.2m)	D2	
Creative PC9000 EDAN: M9... BIOCARE: BM9000 Goldway; CONTEC; DHR960...			S0040B-L	635170404	Adult Finger Clip, 10ft(3m)	/	C2
			S0040C-L	635210404	Pediatric Finger Clip, 10ft(3m)		C0
			S0040D-L	635120404	Adult Silicone Soft, 10ft(3m)		C0
			S0040P-L	635220404	Pediatric Silicone Soft, 10ft(3m)		C0
			S0040F-L	635430404	Neonate Silicone Wrap, 10ft(3m)		C0
			S0040I-L	635190404	Multi-site Y, 10ft(3m)		C0
			S0040G-L	635140404	Adult Ear Clip, 10ft(3m)		C0
<b>Compatible Colin (Omron)</b>							
BP88S			S0001B-L	635170014	Adult Finger Clip, 10ft(3m)	/	C0
			S0001C-L	635210014	Pediatric Finger Clip, 10ft(3m)		D2
			S0001D-L	635120014	Adult Silicone Soft, 10ft(3m)		D2
			S0001P-L	635220014	Pediatric Silicone Soft, 10ft(3m)		D2
			S0001F-L	635430014	Neonate Silicone Wrap, 10ft(3m)		D2
			S0001I-L	635190014	Multi-site Y, 10ft(3m)		D2
			S0001G-L	635140014	Adult Ear Clip, 10ft(3m)		D2

OEM Manufacturer & Models	Instrument Connector	OEM#	Old Order Code	New Order Code	Descriptions	Adapter Cable	Price
<b>Compatible Colin (Omron)</b>							
BP88S (Oxismart tech)			S0010B-S	635170102	Adult Finger Clip,3ft(0.9m)	Need S0008CO-L (SCP-10) Instrument Connector:	B5
			S0010C-S	635210102	Pediatric Finger Clip,3ft(0.9m)		C4
			S0010D-S	635120102	Adult Silicone Soft,3ft(0.9m)		C4
			S0010P-S	635220102	Pediatric Silicone Soft,3ft(0.9m)		C4
			S0010F-S	635430102	Neonate Silicone Wrap, 3ft(0.9m)		C4
			S0010I-S	635190106	Multi-site Y, 4ft(1.2m)		C4
			S0010G-S	635140102	Adult Ear Clip, 3ft(0.9m)		C4
BP-306, BP-508, BP-808, BP-88, BP-88S, BP-S510, Press-Mate, T105NXM (Oxismart tech)			S0010B-S	635170102	Adult Finger Clip,3ft(0.9m)	Need S0010NE-L Instrument Connector:	B5
			S0010C-S	635210102	Pediatric Finger Clip,3ft(0.9m)		C4
			S0010D-S	635120102	Adult Silicone Soft,3ft(0.9m)		C4
			S0010P-S	635220102	Pediatric Silicone Soft,3ft(0.9m)		C4
			S0010F-S	635430102	Neonate Silicone Wrap, 3ft(0.9m)	Sensor Connector:	C4
			S0010I-S	635190106	Multi-site Y, 4ft(1.2m)		C4
			S0010G-S	635140102	Adult Ear Clip, 3ft(0.9m)		
BX 10NE (Oximax Tech)		DS100A	S0026B-S	635170262	Adult Finger Clip,3ft(0.9m)	Need S0117OX-L Instrument Connector:	C2
			S0026C-S	635210262	Pediatric Finger Clip,3ft(0.9m)		C2
			S0026D-S	635120262	Adult Silicone Soft,3ft(0.9m)		D5
			S0026P-S	635220262	Pediatric Silicone Soft,3ft(0.9m)		D5
			S0026F-S	635430262	Neonate Silicone Wrap, 3ft(0.9m)	Sensor Connector:	D5
		D-YS	S0026I-S	635190266	Multi-site Y, 4ft(1.2m)		D5
	S0026G-S	635140262	Adult Ear Clip, 3ft(0.9m)		D5		
BX 10MA (Compatible Masimo Tech)			S0442B-S	635174422	Adult Finger Clip,3ft(0.9m)	Need S0442CS-L Instrument Connector:	C0
			S0442C-S	635214422	Pediatric Finger Clip,3ft(0.9m)		C0
			S0442D-S	635124422	Adult Silicone Soft,3ft(0.9m)		C0
			S0442P-S	635224422	Pediatric Silicone Soft,3ft(0.9m)		C0
			S0442E-S	635324422	Infant Silicone Soft, 3ft(0.9m)	Sensor Connector:	C0
			S0442F-S	635434422	Neonate Silicone Wrap, 3ft(0.9m)		C0
			S0442I-S	635194426	Multi-site Y, 4ft(1.2m)		C0
	S0442G-S	635144422	Adult Ear Clip, 3ft(0.9m)		C0		
<b>Compatible Comen (China)</b>							
STAR-1000			S0066B-L	635170664	Adult Finger Clip,10ft(3m)	/	C0
			S0066C-L	635210664	Pediatric Finger Clip,10ft(3m)		D2
			S0066D-L	635120664	Adult Silicone Soft,10ft(3m)		D2
			S0066P-L	635220664	Pediatric Silicone Soft,10ft(3m)		D2
			S0066F-L	635430664	Neonate Silicone Wrap, 10ft(3m)		D2
			S0066I-L	635190664	Multi-site Y, 10ft(3m)		D2
			S0066G-L	635140664	Adult Ear Clip, 10ft(3m)		D2

OEM Manufacturer & Models	Instrument Connector	OEM#	Old Order Code	New Order Code	Descriptions	Adapter Cable	Price	
<b>Compatible Comen (China)</b>								
C60 Neonatal Dedicated Monitor (Masimo Tech)			S0442B-S	635174422	Adult Finger Clip, 3ft(0.9m)	Need S0117OX-L Instrument Connector:	C0	
			S0442C-S	635214422	Pediatric Finger Clip, 3ft(0.9m)		C0	
			S0442D-S	635124422	Adult Silicone Soft, 3ft(0.9m)		C0	
				S0442P-S	635224422	Pediatric Silicone Soft, 3ft(0.9m)		C0
				S0442E-S	635324422	Infant Silicone Soft, 3ft(0.9m)	Sensor Connector:	C0
				S0442F-S	635434422	Neonate Silicone Wrap, 3ft(0.9m)		C0
					S0442I-S	635194426	Multi-site Y, 4ft(1.2m)	
			S0442G-S	635144422	Adult Ear Clip, 3ft(0.9m)		C0	
Star-8000 Series, star-5000 Series, c50 (Digital Tech)			S0400B-L	635174004	Adult Finger Clip, 10ft(3m)	/	C0	
			S0400C-L	635214004	Pediatric Finger Clip, 10ft(3m)		D2	
			S0400D-L	635124004	Adult Silicone Soft, 10ft(3m)		D2	
			S0400P-L	635224004	Pediatric Silicone Soft, 10ft(3m)		D2	
			S0400F-L	635434004	Neonate Silicone Wrap, 10ft(3m)		D2	
			S0400I-L	635194004	Multi-site Y, 10ft(3m)		D2	
			S0400G-L	635144004	Adult Ear Clip, 10ft(3m)		D2	
C60, C80, NC Series (Oximax Tech)			S0411B-L	635174114	Adult Finger Clip, 10ft(3m)	/	C0	
			S0411C-L	635214114	Pediatric Finger Clip, 10ft(3m)		D2	
			S0411D-L	635124114	Adult Silicone Soft, 10ft(3m)		D2	
			S0411P-L	635224114	Pediatric Silicone Soft, 10ft(3m)		D2	
			S0411F-L	635434114	Neonate Silicone Wrap, 10ft(3m)		D2	
			S0411I-L	635194114	Multi-site Y, 10ft(3m)		D2	
			S0411G-L	635144114	Adult Ear Clip, 10ft(3m)		D2	
Comen C80 (Digital Tech)			S0530B-L	635175304	Adult Finger Clip, 10ft(3m)	/	C0	
			S0530C-L	635215304	Pediatric Finger Clip, 10ft(3m)		D2	
			S0530D-L	635125304	Adult Silicone Soft, 10ft(3m)		D2	
			S0530P-L	635225304	Pediatric Silicone Soft, 10ft(3m)		D2	
			S0530F-L	635435304	Neonate Silicone Wrap, 10ft(3m)		D2	
			S0530I-L	635195304	Multi-site Y, 10ft(3m)		D2	
			S0530G-L	635145304	Adult Ear Clip, 10ft(3m)		D2	
Comen NC12				635175534	Adult Finger Clip, 10ft(3m)	/	C0	
				635215534	Pediatric Finger Clip, 10ft(3m)		D2	
				635125534	Adult Silicone Soft, 10ft(3m)		D2	
				635225534	Pediatric Silicone Soft, 10ft(3m)		D2	
				635435534	Neonate Silicone Wrap, 10ft(3m)		D2	
				635195534	Multi-site Y, 10ft(3m)		D2	
			635145534	Adult Ear Clip, 10ft(3m)	D2			

OEM Manufacturer & Models	Instrument Connector	OEM#	Old Order Code	New Order Code	Descriptions	Adapter Cable	Price
<b>Compatible Comen (China)</b>							
Comen C30/C50/C60/C80/C90 (Nellcor OxiMax)				635175684	Adult Finger Clip, 10ft(3m)	/	C0
				635215684	Pediatric Finger Clip, 10ft(3m)		D2
				635125684	Adult Silicone Soft, 10ft(3m)		D2
				635225684	Pediatric Silicone Soft, 10ft(3m)		D2
				635435684	Neonate Silicone Wrap, 10ft(3m)		D2
				635195684	Multi-site Y, 10ft(3m)		D2
			635145684	Adult Ear Clip, 10ft(3m)	D2	D2	
<b>Compatible Creative (China)</b>							
UP-6000, PC-9000			S0010B-S	635170102	Adult Finger Clip, 3ft(0.9m)	Need S0010NE-L Instrument Connector:  Sensor Connector: 	B5
			S0010C-S	635210102	Pediatric Finger Clip, 3ft(0.9m)		C4
			S0010D-S	635120102	Adult Silicone Soft, 3ft(0.9m)		C4
			S0010P-S	635220102	Pediatric Silicone Soft, 3ft(0.9m)		C4
			S0010F-S	635430102	Neonate Silicone Wrap, 3ft(0.9m)		C4
			S0010I-S	635190106	Multi-site Y, 4ft(1.2m)		C4
			S0010G-S	635140102	Adult Ear Clip, 3ft(0.9m)		C4
PC9000, UP6000 TOB-MED: TOM MS-6-P EDAN: M9, M99A, M8, M8A, M8B, M3, M3B Goldway, CONTEC, DHR960			S0063B-L	635170634	Adult Finger Clip, 10ft(3m)	/	C0
			S0063C-L	635210634	Pediatric Finger Clip, 10ft(3m)		D2
			S0063D-L	635120634	Adult Silicone Soft, 10ft(3m)		D2
			S0063P-L	635220634	Pediatric Silicone Soft, 10ft(3m)		D2
			S0063F-L	635430634	Neonate Silicone Wrap, 10ft(3m)		D2
			S0063I-L	635190634	Multi-site Y, 10ft(3m)		D2
			S0063G-L	635140634	Adult Ear Clip, 10ft(3m)		D2
UP-7000, UP-9000, PC-900, PC-900A, PC-900S PC-900, SNPC-3000, PC-5000A/B, PC-9000B, PC-66A, PC-66B, PC-66V (Digital tech)			S0108B-S	635171082	Adult Finger Clip, 3ft(0.9m)	/	D2
			S0108C-S	635211082	Pediatric Finger Clip, 3ft(0.9m)		D2
			S0108D-S	635121082	Adult Silicone Soft, 3ft(0.9m)		D2
			S0108P-S	635221082	Pediatric Silicone Soft, 3ft(0.9m)		D2
			S0108F-S	635431082	Neonate Silicone Wrap, 3ft(0.9m)		D2
			S0108I-S	635191086	Multi-site Y, 4ft(1.2m)		D2
			S0108G-S	635141082	Adult Ear Clip, 3ft(0.9m)		D2
			S0160B-L	635171604	Adult Finger Clip, 10ft(3m)	/	C0
			S0160C-L	635211604	Pediatric Finger Clip, 10ft(3m)		D2
			S0160D-L	635121604	Adult Silicone Soft, 10ft(3m)		D2
			S0160P-L	635221604	Pediatric Silicone Soft, 10ft(3m)		D2
			S0160F-L	635431604	Neonate Silicone Wrap, 10ft(3m)		D2
			S0160I-L	635191604	Multi-site Y, 10ft(3m)		D2
			S0160G-L	635141604	Adult Ear Clip, 10ft(3m)		D2

OEM Manufacturer & Models	Instrument Connector	OEM#	Old Order Code	New Order Code	Descriptions	Adapter Cable	Price
<b>Compatible Creative (CSI)</b>							
510, 503, 504, 507, 507SD, 508, 581, 1100, 8100, Poet (602-3A), Scholar (CSI Tech)			S0044B-S	635170442	Adult Finger Clip, 3ft(0.9m)	Need S0100BC-L Instrument Connector:  Sensor Connector: 	C0
			S0044C-S	635210442	Pediatric Finger Clip, 3ft(0.9m)		D2
			S0044D-S	635120442	Adult Silicone Soft, 3ft(0.9m)		D2
			S0044P-S	635220442	Pediatric Silicone Soft, 3ft(0.9m)		D2
			S0044F-S	635430442	Neonate Silicone Wrap, 3ft(0.9m)		D2
			S0044I-S	635190446	Multi-site Y, 4ft(1.2m)		D2
		1563-10L	S0100B-L	635171004	Adult Finger Clip, 10ft(3m)	/	D0
			S0100C-L	635211004	Pediatric Finger Clip, 10ft(3m)		D0
			S0100D-L	635121004	Adult Silicone Soft, 10ft(3m)		D0
			S0100P-L	635221004	Pediatric Silicone Soft, 10ft(3m)		D0
			S0100F-L	635431004	Neonate Silicone Wrap, 10ft(3m)		D0
			S0100I-L	635191004	Multi-site Y, 10ft(3m)		D0
			S0100G-L	635141004	Adult Ear Clip, 10ft(3m)		D0
	503 Spot, 503DX, 503DX-W, 503S, 504DX, Scholar (CSI Tech)		934-10DN, CAT93410DN	S0044B-L	635170444	Adult Finger Clip, 10ft(3m)	/
			S0044C-L	635210444	Pediatric Finger Clip, 10ft(3m)	D2	
			S0044D-L	635120444	Adult Silicone Soft, 10ft(3m)	D2	
			S0044P-L	635220444	Pediatric Silicone Soft, 10ft(3m)	D2	
			S0044F-L	635430444	Neonate Silicone Wrap, 10ft(3m)	D2	
			S0044I-L	635190444	Multi-site Y, 10ft(3m)	D2	
	S0044G-L	635140444	Adult Ear Clip, 10ft(3m)	D2			
<b>Compatible Dolphin Medical (OSI)</b>							
Dolphin ONE Oximeters 2150, 2100 compatible for: 2G00751. original factory code: 201 original factory code: 360 digital PD output directly DS.		210	S0099B-S	635170992	Adult Finger Clip, 3ft(0.9m)	Need S0099BC-L Instrument Connector:  Sensor Connector: 	C0
			S0099C-S	635210992	Pediatric Finger Clip, 3ft(0.9m)		D2
			S0099D-S	635120992	Adult Silicone Soft, 3ft(0.9m)		D2
			S0099P-S	635220992	Pediatric Silicone Soft, 3ft(0.9m)		D2
			S0099F-S	635430992	Neonate Silicone Wrap, 3ft(0.9m)		D2
			S0099I-S	635190996	Multi-site Y, 4ft(1.2m)		D2
			S0099G-S	635140992	Adult Ear Clip, 3ft(0.9m)		D2
			S0099B-L	635170994	Adult Finger Clip, 10ft(3m)	/	D8
			S0099C-L	635210994	Pediatric Finger Clip, 10ft(3m)		D0
			S0099D-L	635120994	Adult Silicone Soft, 10ft(3m)		D0
			S0099P-L	635220994	Pediatric Silicone Soft, 10ft(3m)		D0
			S0099F-L	635430994	Neonate Silicone Wrap, 10ft(3m)		D0
			S0099I-L	635190994	Multi-site Y, 10ft(3m)		D0
			S0099G-L	635140994	Adult Ear Clip, 10ft(3m)		D0

OEM Manufacturer & Models	Instrument Connector	OEM#	Old Order Code	New Order Code	Descriptions	Adapter Cable	Price
<b>Compatible Dixtal (Brazil)</b>							
DX 2010, DX 2020, DX 2021, DX 2022, DX 2023, DX 2025, DX 2405, DX 2515, DX 405, DX 7100, DX 7300, DX 8100			S0406B-L	635174064	Adult Finger Clip, 10ft(3m)	/	D8
			S0406C-L	635214064	Pediatric Finger Clip, 10ft(3m)		D0
			S0406D-L	635124064	Adult Silicone Soft, 10ft(3m)		D0
			S0406P-L	635224064	Pediatric Silicone Soft, 10ft(3m)		D0
			S0406F-L	635434064	Neonate Silicone Wrap, 10ft(3m)		D0
			S0406I-L	635194064	Multi-site Y, 10ft(3m)		D0
			S0406G-I	635144064	Adult Ear Clip, 10ft(3m)		D0
<b>Compatible Datascope</b>							
3000A, Accusat, Accutorr 3 SAT Passport Datascope 3000		0600-00 0026-02	S0052B-L	635170524	Adult Finger Clip, 10ft(3m)	/	C0
			S0052C-L	635210524	Pediatric Finger Clip, 10ft(3m)		D2
			S0052D-L	635120524	Adult Silicone Soft, 10ft(3m)		D2
			S0052P-L	635220524	Pediatric Silicone Soft, 10ft(3m)		D2
			S0052F-L	635430524	Neonate Silicone Wrap, 10ft(3m)		D2
			S0052I-L	635190524	Multi-site Y, 10ft(3m)		D2
			S0052G-L	635140524	Adult Ear Clip, 10ft(3m)		D2
Accutorr Plus PassportII, Exper, (OxiSmart tech)			S0010B-S	635170102	Adult Finger Clip, 3ft(0.9m)	Need S0010NE-L Instrument Connector:	B5
			S0010C-S	635210102	Pediatric Finger Clip, 3ft(0.9m)		C4
			S0010D-S	635120102	Adult Silicone Soft, 3ft(0.9m)		 C4
			S0010P-S	635220102	Pediatric Silicone Soft, 3ft(0.9m)		Sensor Connector: C4
			S0010F-S	635430102	Neonate Silicone Wrap, 3ft(0.9m)		C4
			S0010I-S	635190106	Multi-site Y, 4ft(1.2m)		 C4
			S0010G-S	635140102	Adult Ear Clip, 3ft(0.9m)		C4
Accutorr Plus, BeneView T1, DPM5, DPM6, DPM7, Duo, Expert, MEC-1200 Vet, PM-9000Vet, Passport Series Passport XG, Spectrum, Spectrum OR, Trio, V-Series, V12 (Oximax tech)		DS100A	S0026B-S	635170262	Adult Finger Clip, 3ft(0.9m)	Need S0117OX-L Instrument Connector:	C2
			S0026C-S	635210262	Pediatric Finger Clip, 3ft(0.9m)		C2
			S0026D-S	635120262	Adult Silicone Soft, 3ft(0.9m)		 D5
			S0026P-S	635220262	Pediatric Silicone Soft, 3ft(0.9m)		Sensor Connector: D5
			S0026F-S	635430262	Neonate Silicone Wrap, 3ft(0.9m)		D5
		D-YS	S0026I-S	635190266	Multi-site Y, 4ft(1.2m)		 D5
			S0026G-S	635140262	Adult Ear Clip, 3ft(0.9m)		D5

OEM Manufacturer & Models	Instrument Connector	OEM#	Old Order Code	New Order Code	Descriptions	Adapter Cable	Price	
<b>Compatible Datascope</b>								
Accutor plus (Compatible Masimo Tech)		2053	S0442B-L	635174424	Adult Finger Clip, 10ft(3m)	/	D0	
			S0442C-L	635214424	Pediatric Finger Clip, 10ft(3m)		D0	
			S0442D-L	635124424	Adult Silicone Soft, 10ft(3m)		D0	
			S0442P-L	635224424	Pediatric Silicone Soft, 10ft(3m)		D0	
			S0442E-L	635324424	Infant Silicone Soft, 10ft(3m)		D0	
			S0442F-L	635434424	Neonate Silicone Wrap, 10ft(3m)		D0	
			S0442I-L	635194424	Multi-site Y, 10ft(3m)		D0	
			S0442G-L	635144424	Adult Ear Clip, 10ft(3m)		D0	
				635184422	Adult Silicone ring type, 3ft (3m)	D0		
				S0442B-S	635174422	Adult Finger Clip, 3ft(0.9m)	Need S0442CS-L Instrument Connector:	C0
			S0442C-S	635214422	Pediatric Finger Clip, 3ft(0.9m)		C0	
			S0442D-S	635124422	Adult Silicone Soft, 3ft(0.9m)		C0	
			S0442P-S	635224422	Pediatric Silicone Soft, 3ft(0.9m)	Sensor Connector:	C0	
			S0442E-S	635324422	Infant Silicone Soft, 3ft(0.9m)		C0	
			S0442F-S	635434422	Neonate Silicone Wrap, 3ft(0.9m)		C0	
			S0442I-S	635194426	Multi-site Y, 4ft(1.2m)		C0	
				S0442G-S	635144422	Adult Ear Clip, 3ft(0.9m)	C0	
<b>Compatible Drager</b>								
Infinity Delta/XL, Infinity Gamma, Infinity Gamma X/XL, Infinity Kappa/XLT, Infinity Vista/XL, SC 6000, SC 6002XL, SC 7000, SC 8000, SC 9000, SC 9000X (OxiSmart Tech)			S0072B-L	635170724	Adult Finger Clip, 10ft(3m)	/	C0	
			S0072C-L	635210724	Pediatric Finger Clip, 10ft(3m)		D2	
			S0072D-L	635120724	Adult Silicone Soft, 10ft(3m)		D2	
			S0072P-	635220724	Pediatric Silicone Soft, 10ft(3m)		D2	
			S0072F-L	635430724	Neonate Silicone Wrap, 10ft(3m)		D2	
			S0072I-L	635190724	Multi-site Y, 10ft(3m)		D2	
			S0072G-L	635140724	Adult Ear Clip, 10ft(3m)		D2	
				S0010B-S	635170102	Adult Finger Clip, 3ft(0.9m)	Need S0072BC-L S0072BC-S Instrument Connector:	B5
			S0010C-S	635210102	Pediatric Finger Clip, 3ft(0.9m)		C4	
			S0010D-S	635120102	Adult Silicone Soft, 3ft(0.9m)		C4	
			S0010P-S	635220102	Pediatric Silicone Soft, 3ft(0.9m)	Sensor Connector:	C4	
			S0010F-S	635430102	Neonate Silicone Wrap, 3ft(0.9m)		C4	
			S0010I-S	635190106	Multi-site Y, 4ft(1.2m)		C4	
			S0010G-S	635140102	Adult Ear Clip, 3ft(0.9m)		C4	

OEM Manufacturer & Models	Instrument Connector	OEM#	Old Order Code	New Order Code	Descriptions	Adapter Cable	Price	
<b>Compatible Drager</b>								
Narkomed 6400 (OxiMax Tech)		7262764,MS13235,DS100A	S0026B-S	635170262	Adult Finger Clip,3ft(0.9m)	Need S0072OX-L Instrument Connector:	C2	
			S0026C-S	635210262	Pediatric Finger Clip,3ft(0.9m)		C2	
			S0026D-S	635120262	Adult Silicone Soft,3ft(0.9m)		D5	
			S0026P-S	635220262	Pediatric Silicone Soft,3ft(0.9m)		D5	
			S0026F-S	635430262	Neonate Silicone Wrap, 3ft(0.9m)		D5	
			MX01004 D-YS	S0026I-S	635190266	Multi-site Y, 4ft(1.2m)		D5
			S0026G-S	635140262	Adult Ear Clip, 3ft(0.9m)	D5		
Oxipac 2000, Oxipac 2500 (BCI Tech)		3044	S0076B-S	635170762	Adult Finger Clip,3ft(0.9m)	/	C2	
		3178	S0076C-S	635210762	Pediatric Finger Clip,3ft(0.9m)		C4	
		3044	S0076D-S	635120762	Adult Silicone Soft,3ft(0.9m)		C4	
			S0076P-S	635220762	Pediatric Silicone Soft,3ft(0.9m)		C4	
		3178	S0076E-S	635320762	Infant Silicone Soft, 3ft (0.9m)		C4	
			S0076F-S	635430762	Neonate Silicone Wrap, 3ft(0.9m)		C4	
			S0076I-S	635190766	Multi-site Y, 4ft(1.2m)		C4	
			S0076G-S	635140762	Adult Ear Clip, 3ft(0.9m)		C4	
Infinity M540, Narkomed 6400 (Compatible Masimo Tech)		2053	S0442B-L	635174424	Adult Finger Clip,10ft(3m)	/	D0	
			S0442C-L	635214424	Pediatric Finger Clip,10ft(3m)		D0	
			S0442D-L	635124424	Adult Silicone Soft,10ft(3m)		D0	
			S0442P-L	635224424	Pediatric Silicone Soft,10ft(3m)		D0	
			S0442E-L	635324424	Infant Silicone Soft, 10ft (3m)		D0	
			S0442F-L	635434424	Neonate Silicone Wrap, 10ft(3m)		D0	
			S0442I-L	635194424	Multi-site Y, 10ft(3m)		D0	
			S0442G-L	635144424	Adult Ear Clip, 10ft(3m)		D0	
				635184422	Adult Silicone ring type, 3ft (0.9m)		D0	
			S0442B-S	635174422	Adult Finger Clip,3ft(0.9m)	Need S0442CS-L Instrument Connector:	C0	
			S0442C-S	635214422	Pediatric Finger Clip,3ft(0.9m)		C0	
			S0442D-S	635124422	Adult Silicone Soft,3ft(0.9m)		C0	
			S0442P-S	635224422	Pediatric Silicone Soft,3ft(0.9m)		C0	
			S0442E-S	635324422	Infant Silicone Soft, 3ft (0.9m)		C0	
			S0442F-S	635434422	Neonate Silicone Wrap, 3ft(0.9m)		C0	
			S0442I-S	635194426	Multi-site Y, 4ft(1.2m)		C0	
	S0442G-S	635144422	Adult Ear Clip, 3ft(0.9m)	C0				

OEM Manufacturer & Models	Instrument Connector	OEM#	Old Order Code	New Order Code	Descriptions	Adapter Cable	Price
<b>Compatible Drager</b>							
Cicero, Infinity Delta XL, Infinity Gamma XL, Infinity Kappa, Julian, Vitalert 1000 (OxiSmart Tech)			S0119B-L	635171194	Adult Finger Clip, 10ft(3m)	/	E0
			S0119C-L	635211194	Pediatric Finger Clip, 10ft(3m)		E0
			S0119D-L	635121194	Adult Silicone Soft, 10ft(3m)		E0
			S0119P-L	635221194	Pediatric Silicone Soft, 10ft(3m)		E0
			S0119F-L	635431194	Neonate Silicone Wrap, 10ft(3m)		E0
			S0119I-L	635191194	Multi-site Y, 10ft(3m)		E0
			S0119G-L	635141194	Adult Ear Clip, 10ft(3m)		E0
			S0010B-S	635170102	Adult Finger Clip, 3ft(0.9m)	Need S0119NE-L (M35370) Instrument Connector:	B5
			S0010C-S	635210102	Pediatric Finger Clip, 3ft(0.9m)		C4
			S0010D-S	635120102	Adult Silicone Soft, 3ft(0.9m)		C4
			S0010P-S	635220102	Pediatric Silicone Soft, 3ft(0.9m)		C4
			S0010F-S	635430102	Neonate Silicone Wrap, 3ft(0.9m)	Sensor Connector:	C4
			S0010I-S	635190106	Multi-site Y, 4ft(1.2m)		C4
			S0010G-S	635140102	Adult Ear Clip, 3ft(0.9m)		C4
Drager (Oxi-Tech)+ infinity Gamma XL				635170734	Adult Finger Clip, 10ft(3m)	/	C2
				635210734	Pediatric Finger Clip, 10ft(3m)		C2
				635120734	Adult Silicone Soft, 10ft(3m)		D5
				635220734	Pediatric Silicone Soft, 10ft(3m)		D5
				635430734	Neonate Silicone Wrap, 10ft(3m)		D5
				635190734	Multi-site Y, 10ft(3m)		D5
				635140734	Adult Ear Clip, 10ft(3m)		D5
<b>Compatible Emtel</b>							
Fx2000 (OxiSmart Tech)		DS100A	S0026B-S	635170262	Adult Finger Clip, 3ft(0.9m)	Need S0178OX-L Instrument Connector:	C2
			S0026C-S	635210262	Pediatric Finger Clip, 3ft(0.9m)		C2
			S0026D-S	635120262	Adult Silicone Soft, 3ft(0.9m)		D5
			S0026P-S	635220262	Pediatric Silicone Soft, 3ft(0.9m)		D5
			S0026F-S	635430262	Neonate Silicone Wrap, 3ft(0.9m)	Sensor Connector:	D5
		D-YS	S0026I-S	635190266	Multi-site Y, 4ft(1.2m)		D5
			S0026G-S	635140262	Adult Ear Clip, 3ft(0.9m)		D5
<b>Compatible Edan (China), See Nellcor</b>							
EDAN Oximetry M3, M3A, M3B, M8, M8A, M8B, M9, M9A, M50, M80, iM8, iM8A, iM8B, iM9, iM9A, iM50, iM80 (Oxismart Non-Oximax)		MS3-109069	S0040B-L	635170404	Adult Finger Clip, 10ft(3m)	/	C0
			S0040C-L	635210404	Pediatric Finger Clip, 10ft(3m)		C2
			S0040D-L	635120404	Adult Silicone Soft, 10ft(3m)		C2
			S0040P-L	635220404	Pediatric Silicone Soft, 10ft(3m)		C2
			S0040F-L	635430404	Neonate Silicone Wrap, 10ft(3m)		C2
			S0040I-L	635190404	Multi-site Y, 10ft(3m)		C2
			S0040G-L	635140404	Adult Ear Clip, 10ft(3m)		C2





OEM Manufacturer & Models	Instrument Connector	OEM#	Old Order Code	New Order Code	Descriptions	Adapter Cable	Price
<b>Compatible Edan (China), See Nellcor</b>							
Digital Tech			S0424B-L	635174244	Adult Finger Clip, 10ft(3m)	/	C0
			S0424C-L	635214244	Pediatric Finger Clip, 10ft(3m)		D2
			S0424D-L	635124244	Adult Silicone Soft, 10ft(3m)		D2
			S0424P-L	635224244	Pediatric Silicone Soft, 10ft(3m)		D2
			S0424F-L	635434244	Neonate Silicone Wrap, 10ft(3m)		D2
			S0424I-L	635194244	Multi-site Y, 10ft(3m)		D2
			S0424G-L	635144244	Adult Ear Clip, 10ft(3m)		D2
EDAN M3/ M4/M9/IM9/ IM80 (Nellcor Oxismart )				635174164	Adult Finger Clip, 10ft(3m)	/	C2
				635214164	Pediatric Finger Clip, 10ft(3m)		C4
				635124164	Adult Silicone Soft, 10ft(3m)		C4
				635224164	Pediatric Silicone Soft, 10ft(3m)		C4
				635434164	Neonate Silicone Wrap, 10ft(3m)		C4
				635194164	Multi-site Y, 10ft(3m)		C4
				635144164	Adult Ear Clip, 10ft(3m)		C4
<b>Compatible Fukuda Denshi, See Nellcor/Oximax Tech.</b>							
DS7100- DS7300 (Nellcor Oximax )		DS100A	S0026B-S	635170262	Adult Finger Clip, 3ft(0.9m)	Need S0117OX-L Instrument Connector:  Sensor Connector: 	C2
			S0026C-S	635210262	Pediatric Finger Clip, 3ft(0.9m)		C2
			S0026D-S	635120262	Adult Silicone Soft, 3ft(0.9m)		D5
			S0026P-S	635220262	Pediatric Silicone Soft, 3ft(0.9m)		D5
			S0026F-S	635430262	Neonate Silicone Wrap, 3ft(0.9m)		D5
		D-YS	S0026I-S	635190266	Multi-site Y, 4ft(1.2m)		D5
			S0026G-S	635140262	Adult Ear Clip, 3ft(0.9m)		D5
<b>Compatible GMI (General Meditech Inc.)</b>							
G2A Vital Signs Monitor, G3D, G3A, G3C Patient monitor, G3D, G3F, G3G Patient monitor, G3H Patient monitor, digital PD output directly DS.			S0108B-L	635171084	Adult Finger Clip, 10ft(3m)	/	C0
			S0108C-L	635211084	Pediatric Finger Clip, 10ft(3m)		D2
			S0108D-L	635121084	Adult Silicone Soft, 10ft(3m)		D2
			S0108P-L	635221084	Pediatric Silicone Soft, 10ft(3m)		D2
			S0108F-L	635431084	Neonate Silicone Wrap, 10ft(3m)		D2
			S0108I-L	635191084	Multi-site Y, 10ft(3m)		D2
			S0108G-L	635141084	Adult Ear Clip, 10ft(3m)		D2
NT1, NT1A			S0108B-S	635171082	Adult Finger Clip, 3ft(0.9m)	/	D5
			S0108C-S	635211082	Pediatric Finger Clip, 3ft(0.9m)		D0
			S0108D-S	635121082	Adult Silicone Soft, 3ft(0.9m)		D0
			S0108P-S	635221082	Pediatric Silicone Soft, 3ft(0.9m)		D0
			S0108F-S	635431082	Neonate Silicone Wrap, 3ft(0.9m)		D0
			S0108I-S	635191086	Multi-site Y, 4ft(1.2m)		D0
			S0108G-S	635141082	Adult Ear Clip, 3ft(0.9m)		D0

OEM Manufacturer & Models	Instrument Connector	OEM#	Old Order Code	New Order Code	Descriptions	Adapter Cable	Price
<b>Compatible GMI (General Meditech Inc.)</b>							
NT3A, NT3B, NT3E, NT3F, NT3B 60 (Digital Tech)			S0402B-L	635174024	Adult Finger Clip, 10ft(3m)	/	C0
			S0402C-L	635214024	Pediatric Finger Clip, 10ft(3m)		D2
			S0402D-L	635124024	Adult Silicone Soft, 10ft(3m)		D2
			S0402P-L	635224024	Pediatric Silicone Soft, 10ft(3m)		D2
			S0402F-L	635434024	Neonate Silicone Wrap, 10ft(3m)		D2
			S0402I-L	635194024	Multi-site Y, 10ft(3m)		D2
			S0402G-L	635144024	Adult Ear Clip, 10ft(3m)		D2
<b>Compatible GE Critikon</b>							
Dianmap, ProCare, ProSeries V2Pro1000 V3 (Oxi Tech)		DS100A	S0026B-S	635170262	Adult Finger Clip, 3ft(0.9m)	Need S0117OX-L Instrument Connector:	C2
			S0026C-S	635210262	Pediatric Finger Clip, 3ft(0.9m)		C2
			S0026D-S	635120262	Adult Silicone Soft, 3ft(0.9m)		D5
			S0026P-S	635220262	Pediatric Silicone Soft, 3ft(0.9m)		 D5
			S0026F-S	635430262	Neonate Silicone Wrap, 3ft(0.9m)		Sensor Connector: D5
		D-YS	S0026I-S	635190266	Multi-site Y, 4ft(1.2m)		D5
			S0026G-S	635140262	Adult Ear Clip, 3ft(0.9m)		 D5
Dianmap 9700/9701 9702 PLUS, MPS ORTABLE, /COMPACT, (OxiSmart) (Non-oximax)			S0010B-S	635170102	Adult Finger Clip, 3ft(0.9m)	Need S0010NE-L (EC-8) Instrument Connector:	B5
			S0010C-S	635210102	Pediatric Finger Clip, 3ft(0.9m)		C4
			S0010D-S	635120102	Adult Silicone Soft, 3ft(0.9m)		C4
			S0010P-S	635220102	Pediatric Silicone Soft, 3ft(0.9m)		 C4
			S0010F-S	635430102	Neonate Silicone Wrap, 3ft(0.9m)		Sensor Connector: C4
			S0010I-S	635190106	Multi-site Y, 4ft(1.2m)		C4
			S0010G-S	635140102	Adult Ear Clip, 3ft(0.9m)		 C4
Dianmap, ProSeries V1 Pro 1000 V2 (OxiSmart) (Non-oximax)			S0010B-S	635170102	Adult Finger Clip, 3ft(0.9m)	Need S0008CO-L (SCP-10) Instrument Connector:	B5
			S0010C-S	635210102	Pediatric Finger Clip, 3ft(0.9m)		C4
			S0010D-S	635120102	Adult Silicone Soft, 3ft(0.9m)		C4
			S0010P-S	635220102	Pediatric Silicone Soft, 3ft(0.9m)		 C4
			S0010F-S	635430102	Neonate Silicone Wrap, 3ft(0.9m)		Sensor Connector: C4
			S0010I-S	635190106	Multi-site Y, 4ft(1.2m)		C4
			S0010G-S	635140102	Adult Ear Clip, 3ft(0.9m)		 C4
Dinamap 8700/ 8710/8720 Plus, Critikon Dinamap Oxytrak			S0142B-S	635171422	Adult Finger Clip, 3ft(0.9m)	Need CB-A400-1027A Temporarily unavailable	D5
			S0142C-S	635211422	Pediatric Finger Clip, 3ft(0.9m)		D0
			S0142D-S	635121422	Adult Silicone Soft, 3ft(0.9m)		D0
			S0142P-S	635221422	Pediatric Silicone Soft, 3ft(0.9m)		D0
			S0142F-S	635431422	Neonate Silicone Wrap, 3ft(0.9m)		D0
			S0142I-S	635191426	Multi-site Y, 4ft(1.2m)		D0
			S0142G-S	635141422	Adult Ear Clip, 3ft(0.9m)		D0

OEM Manufacturer & Models	Instrument Connector	OEM#	Old Order Code	New Order Code	Descriptions	Adapter Cable	Price
<b>Compatible GE Critikon</b>							
Dianmap 8700/ 8710/8720 Pulse, Oxyshuttle11 et 2 Critikon Dinamap 8721, 9710, 9700, 8280			S0059B-L	635170594	Adult Finger Clip, 10ft(3m)	/	D0
			S0059C-L	635210594	Pediatric Finger Clip, 10ft(3m)		E5
			S0059D-L	635120594	Adult Silicone Soft, 10ft(3m)		E5
			S0059P-L	635220594	Pediatric Silicone Soft, 10ft(3m)		E5
			S0059F-L	635430594	Neonate Silicone Wrap, 10ft(3m)		E5
			S0059I-L	635190594	Multi-site Y, 10ft(3m)		E5
Dianmap ProCare Series V2 Pro 1000 V3 (Masimo tech)		2053	S0442B-L	635174424	Adult Finger Clip, 10ft(3m)	/	D0
			S0442C-L	635214424	Pediatric Finger Clip, 10ft(3m)		D0
			S0442D-L	635124424	Adult Silicone Soft, 10ft(3m)		D0
			S0442P-L	635224424	Pediatric Silicone Soft, 10ft(3m)		D0
			S0442E-L	635324424	Infant Silicone Soft, 10ft(3m)		D0
			S0442F-L	635434424	Neonate Silicone Wrap, 10ft(3m)		D0
			S0442I-L	635194424	Multi-site Y, 10ft(3m)		D0
			S0442G-L	635144424	Adult Ear Clip, 10ft(3m)		D0
			635184422	Adult Silicone ring type, 3ft (0.9m)	B0		
			S0442B-S	635174422	Adult Finger Clip, 3ft(0.9m)	Need S0442CS-L Instrument Connector:	C0
			S0442C-S	635214422	Pediatric Finger Clip, 3ft(0.9m)		C0
			S0442D-S	635124422	Adult Silicone Soft, 3ft(0.9m)	Sensor Connector:	C0
			S0442P-S	635224422	Pediatric Silicone Soft, 3ft(0.9m)		C0
			S0442E-S	635324422	Infant Silicone Soft, 3ft(0.9m)	C0	
		S0442F-S	635434422	Neonate Silicone Wrap, 3ft(0.9m)	C0		
	S0442I-S	635194426	Multi-site Y, 4ft(1.2m)	C0			
	S0442G-S	635144422	Adult Ear Clip, 3ft(0.9m)	C0			
<b>Compatible GE Corometrics, See Nellcor</b>							
SERIE 250 (Nellcor Oximax)		DS100A	S0026B-S	635170262	Adult Finger Clip, 3ft(0.9m)	Need S0122OX-L Instrument Connector:	C2
			S0026C-S	635210262	Pediatric Finger Clip, 3ft(0.9m)	C2	
			S0026D-S	635120262	Adult Silicone Soft, 3ft(0.9m)		D5
			S0026P-S	635220262	Pediatric Silicone Soft, 3ft(0.9m)	D5	
			S0026F-S	635430262	Neonate Silicone Wrap, 3ft(0.9m)	Sensor Connector:	D5
		D-YS	S0026I-S	635190266	Multi-site Y, 4ft(1.2m)	D5	
			S0026G-S	635140262	Adult Ear Clip, 3ft(0.9m)		D5

OEM Manufacturer & Models	Instrument Connector	OEM#	Old Order Code	New Order Code	Descriptions	Adapter Cable	Price
<b>Compatible GE Corometrics, See Nellcor</b>							
SERIE 250 (OXI-tech)			S0122B-L	635171224	Adult Finger Clip, 10ft(3m)	/	E0
			S0122C-L	635211224	Pediatric Finger Clip, 10ft(3m)		F5
			S0122D-L	635121224	Adult Silicone Soft, 10ft(3m)		F5
			S0122P-L	635221224	Pediatric Silicone Soft, 10ft(3m)		F5
			S0122F-L	635431224	Neonate Silicone Wrap, 10ft(3m)		F5
			S0122I-L	635191224	Multi-site Y, 10ft(3m)		F5
			S0122G-L	635141224	Adult Ear Clip, 10ft(3m)		F5
188, 129, 129F, 128, 128F (OxiSmart) (Non-oximax)			S0010B-S	635170102	Adult Finger Clip, 3ft(0.9m)	Need S0010NE-L Instrument Connector:	B5
			S0010C-S	635210102	Pediatric Finger Clip, 3ft(0.9m)		C4
			S0010D-S	635120102	Adult Silicone Soft, 3ft(0.9m)		C4
			S0010P-S	635220102	Pediatric Silicone Soft, 3ft(0.9m)	Sensor Connector:	C4
			S0010F-S	635430102	Neonate Silicone Wrap, 3ft(0.9m)	C4	
			S0010I-S	635190106	Multi-site Y, 4ft(1.2m)	C4	
			S0010G-S	635140102	Adult Ear Clip, 3ft(0.9m)		C4
120, 510, 511, 118, 556 (OxiSmart) (Non-oximax)			S0010B-S	635170102	Adult Finger Clip, 3ft(0.9m)	Need S0431NE-L Instrument Connector:	B5
			S0010C-S	635210102	Pediatric Finger Clip, 3ft(0.9m)		C4
			S0010D-S	635120102	Adult Silicone Soft, 3ft(0.9m)		C4
			S0010P-S	635220102	Pediatric Silicone Soft, 3ft(0.9m)	Sensor Connector:	C4
			S0010F-S	635430102	Neonate Silicone Wrap, 3ft(0.9m)	C4	
			S0010I-S	635190106	Multi-site Y, 4ft(1.2m)	C4	
			S0010G-S	635140102	Adult Ear Clip, 3ft(0.9m)		C4
128 129 (OxiSmart) (Non-oximax)			S0010B-S	635170102	Adult Finger Clip, 3ft(0.9m)	Need S0002NE-L Instrument Connector:	B5
			S0010C-S	635210102	Pediatric Finger Clip, 3ft(0.9m)		C4
			S0010D-S	635120102	Adult Silicone Soft, 3ft(0.9m)	C4	
			S0010P-S	635220102	Pediatric Silicone Soft, 3ft(0.9m)		C4
			S0010F-S	635430102	Neonate Silicone Wrap, 3ft(0.9m)	Sensor Connector:	C4
			S0010I-S	635190106	Multi-site Y, 4ft(1.2m)	C4	
			S0010G-S	635140102	Adult Ear Clip, 3ft(0.9m)		C4
			S0002B-L	635170024	Adult Finger Clip, 10ft(3m)	/	D5
			S0002C-L	635210024	Pediatric Finger Clip, 10ft(3m)		D5
			S0002D-L	635120024	Adult Silicone Soft, 10ft(3m)		D5
			S0002P-L	635220024	Pediatric Silicone Soft, 10ft(3m)		D5
			S0002F-L	635430024	Neonate Silicone Wrap, 10ft(3m)		D5
			S0002I-L	635190024	Multi-site Y, 10ft(3m)		D5
			S0002G-L	635140024	Adult Ear Clip, 10ft(3m)		D5

OEM Manufacturer & Models	Instrument Connector	OEM#	Old Order Code	New Order Code	Descriptions	Adapter Cable	Price
<b>Compatible GE-Carescape</b>							
Carescape V100		TS-F4-GE TS-F2-GE	S0128B-L	635171284	Adult Finger Clip,10ft(3m)	/	E0
			S0128C-L	635211284	Pediatric Finger Clip,10ft(3m)		E0
		TS-SA4-GE	S0128D-L	635121284	Adult Silicone Soft,10ft(3m)		F5
			S0128P-L	635221284	Pediatric Silicone Soft,10ft(3m)		F5
			S0128E-L	635321284	Infant Silicone Soft, 10ft (3m)		F5
			S0128F-L	635431284	Neonate Silicone Wrap, 10ft(3m)		F5
			S0128I-L	635191284	Multi-site Y, 10ft(3m)		F5
	TS-E4-GE TS-E2-GE	S0128G-L	635141284	Adult Ear Clip, 10ft(3m)	F5		
OXIMAX Module: GE B650 or B850 GE-Dash 2500 (Oxi-tech)			S0122B-L	635171224	Adult Finger Clip,10ft(3m)	/	E0
			S0122C-L	635211224	Pediatric Finger Clip,10ft(3m)		E0
			S0122D-L	635121224	Adult Silicone Soft,10ft(3m)		F5
			S0122P-L	635221224	Pediatric Silicone Soft,10ft(3m)		F5
			S0122F-L	635431224	Neonate Silicone Wrap, 10ft(3m)		F5
			S0122I-L	635191224	Multi-site Y, 10ft(3m)		F5
	S0122G-L	635141224	Adult Ear Clip, 10ft(3m)	F5			
GE Carescape B450, B650, B850 GE-Dash 2500 (Oxi-tech)				635172054	Adult Finger Clip,10ft(3m)	/	E0
				635212054	Pediatric Finger Clip,10ft(3m)		E0
				635122054	Adult Silicone Soft,10ft(3m)		F5
				635222054	Pediatric Silicone Soft,10ft(3m)		F5
				635432054	Neonate Silicone Wrap, 10ft(3m)		F5
				635192054	Multi-site Y, 10ft(3m)		F5
			635142054	Adult Ear Clip, 10ft(3m)	F5		
<b>Compatible GE Datex-Ohmeda</b>							
GE S/5 (i4 E series module built in)		TS-F4-GE TS-F2-GE	S0128B-L	635171284	Adult Finger Clip,10ft(3m)	/	E0
			S0128C-L	635211284	Pediatric Finger Clip,10ft(3m)		E0
		TS-SA4-GE	S0128D-L	635121284	Adult Silicone Soft,10ft(3m)		F5
			S0128P-L	635221284	Pediatric Silicone Soft,10ft(3m)		F5
			S0128E-L	635321284	Infant Silicone Soft, 10ft (3m)		F5
			S0128F-L	635431284	Neonate Silicone Wrap, 10ft(3m)		F5
			S0128I-L	635191284	Multi-site Y, 10ft(3m)		F5
	TS-E4GE TS-E2-GE	S0128G-L	635141284	Adult Ear Clip, 10ft(3m)	F5		





OEM Manufacturer & Models	Instrument Connector	OEM#	Old Order Code	New Order Code	Descriptions	Adapter Cable	Price
<b>Compatible GE Datex-Ohmeda</b>							
AS/3, CS/3, AS/5 (Built in M module) CH/S, CH/RSCG/2S, CARDIOC API-II Capnomac Ultima, Light monitor, Satellite, Oscar (Datex tech)		OXY-F4N SAF-F4, TS-F4-N	S0036B-L	635170364	Adult Finger Clip, 10ft(3m)	/	C5
			S0036C-L	635210364	Pediatric Finger Clip, 10ft(3m)		C0
			S0036D-L	635120364	Adult Silicone Soft, 10ft(3m)		D2
			S0036P-L	635220364	Pediatric Silicone Soft, 10ft(3m)		D2
			S0036F-L	635430364	Neonate Silicone Wrap, 10ft(3m)		D2
			S0036I-L	635190364	Multi-site Y, 10ft(3m)		D2
			OXY-E4-N	S0036G-L	635140364		Adult Ear Clip, 10ft(3m)
		OXY-F-DB	S0036B-S	635170362	Adult Finger Clip, 10ft(3m)	Need S0036BC-L Instrument Connector:	C0
			S0036C-S	635210362	Pediatric Finger Clip, 10ft(3m)		D2
			S0036D-S	635120362	Adult Silicone Soft, 10ft(3m)	Sensor Connector:	D2
			S0036P-S	635220362	Pediatric Silicone Soft, 10ft(3m)		D2
			S0036F-S	635430362	Neonate Silicone Wrap, 10ft(3m)		D2
			S0036I-S	635190366	Multi-site Y, 10ft(3m)		D2
			OXY-E-DB	S0036G-S	635140362	Adult Ear Clip, 10ft(3m)	
3700, 3710, 3770, 3775, Biox3740, 3760, 3800, 3900, 3900P, 4700, 5250RGB, Cardiocap/5, S/5, AS/3 (built in Module N-XOSAT) CS/3 (Built in module M-OSAT) (Ohmeda)		OXY-F-UN	S0123B-S	635171232	Adult Finger Clip, 3ft(0.9m)	Need S0014OH-L Instrument Connector:	C5
			S0123C-S	635211232	Pediatric Finger Clip, 3ft(0.9m)		D2
			S0123D-S	635121232	Adult Silicone Soft, 3ft(0.9m)	Sensor Connector:	D2
			S0123P-S	635221232	Pediatric Silicone Soft, 3ft(0.9m)		D2
			S0123E-S	635321232	Infant Silicone Soft, 3ft (0.9m)		D2
			S0123F-S	635431232	Neonate Silicone Wrap, 3ft(0.9m)		D2
			S0123I-S	635191236	Multi-site Y, 4ft(1.2m)		D2
			OXY-E-UN	S0123G-S	635141232	Adult Ear Clip, 3ft(0.9m)	
		OXY-F4-H	S0014B-L	635170144	Adult Finger Clip, 10ft(3m)	/	C5
			S0014C-L	635210144	Pediatric Finger Clip, 10ft(3m)		C0
			S0014D-1	635120144	Adult Silicone Soft, 10ft(3m)		D2
			S0014P-L	635220144	Pediatric Silicone Soft, 10ft(3m)		D2
			S0014E-L	635320144	Infant Silicone Soft, 10ft (3m)		D2
			S0014F-L	635430144	Neonate Silicone Wrap, 10ft(3m)		D2
		S0014I-L	635190144	Multi-site Y, 10ft(3m)	D2		
	OXY-E4-H	S0014G-L	635140144	Adult Ear Clip, 10ft(3m)	D2		

OEM Manufacturer & Models	Instrument Connector	OEM#	Old Order Code	New Order Code	Descriptions	Adapter Cable	Price
<b>Compatible GE Datex-Ohmeda</b>							
Ohmeda TruSat Ohmeda TruSat TD (+Oxytip Technology)			S0127B-L	635171274	Adult Finger Clip, 10ft(3m)	/	E0
			S0127C-L	635211274	Pediatric Finger Clip, 10ft(3m)		E0
			S0127D-L	635121274	Adult Silicone Soft, 10ft(3m)		F5
			S0127P-L	635221274	Pediatric Silicone Soft, 10ft(3m)		F5
			S0127F-L	635431274	Neonate Silicone Wrap, 10ft(3m)		F5
			S0127I-L	635191274	Multi-site Y, 10ft(3m)		F5
			S0127G-L	635141274	Adult Ear Clip, 10ft(3m)		F5
M-NSAT Module (AS/3, CS/3, S/5) (OxiSmart) (Non-oximax)			S0010B-S	635170102	Adult Finger Clip, 3ft(0.9m)	Need S0001NE-L (MC-10) Instrument Connector:	B5
			S0010C-S	635210102	Pediatric Finger Clip, 3ft(0.9m)		C4
			S0010D-S	635120102	Adult Silicone Soft, 3ft(0.9m)		C4
			S0010P-S	635220102	Pediatric Silicone Soft, 3ft(0.9m)		 C4
			S0010F-S	635430102	Neonate Silicone Wrap, 3ft(0.9m)		Sensor Connector: C4
			S0010I-S	635190106	Multi-site Y, 4ft(1.2m)		C4
			S0010G-S	635140102	Adult Ear Clip, 3ft(0.9m)		 C4
M-NSAT Module (Oxi Tech)		DS100A	S0026B-S	635170262	Adult Finger Clip, 3ft(0.9m)	Need S0117OX-L Instrument Connector:	C2
			S0026C-S	635210262	Pediatric Finger Clip, 3ft(0.9m)		C2
			S0026D-S	635120262	Adult Silicone Soft, 3ft(0.9m)		D5
			S0026P-S	635220262	Pediatric Silicone Soft, 3ft(0.9m)		 D5
			S0026F-S	635430262	Neonate Silicone Wrap, 3ft(0.9m)		Sensor Connector: D5
		D-YS	S0026I-S	635190266	Multi-site Y, 4ft(1.2m)		D5
			S0026G-S	635140262	Adult Ear Clip, 3ft(0.9m)		 D5
<b>Compatible GE Hellige</b>							
Cardioserv Eagle 1000- 3000 (Non-oximax)			S0010B-S	635170102	Adult Finger Clip, 3ft(0.9m)	Need S0006NE-L Instrument Connector:	B5
			S0010C-S	635210102	Pediatric Finger Clip, 3ft(0.9m)		C4
			S0010D-S	635120102	Adult Silicone Soft, 3ft(0.9m)		C4
			S0010P-S	635220102	Pediatric Silicone Soft, 3ft(0.9m)		 C4
			S0010F-S	635430102	Neonate Silicone Wrap, 3ft(0.9m)		Sensor Connector: C4
			S0010I-S	635190106	Multi-site Y, 4ft(1.2m)		C4
			S0010G-S	635140102	Adult Ear Clip, 3ft(0.9m)		 C4
Cardioserv (Oxi Tech)		DS100A	S0026B-S	635170262	Adult Finger Clip, 3ft(0.9m)	Need/ Temporarily available	C2
			S0026C-S	635210262	Pediatric Finger Clip, 3ft(0.9m)		C2
			S0026D-S	635120262	Adult Silicone Soft, 3ft(0.9m)		D5
			S0026P-S	635220262	Pediatric Silicone Soft, 3ft(0.9m)		D5
			S0026F-S	635430262	Neonate Silicone Wrap, 3ft(0.9m)		D5
		D-YS	S0026I-S	635190266	Multi-site Y, 4ft(1.2m)		D5
			S0026G-S	635140262	Adult Ear Clip, 3ft(0.9m)		D5



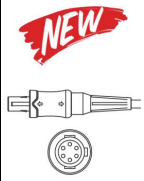



OEM Manufacturer & Models	Instrument Connector	OEM#	Old Order Code	New Order Code	Descriptions	Adapter Cable	Price
<b>Compatible General (China), See Nellcor/Oximax Tech.</b>							
G2A, G3A, G3C, G3D, G3F, G3G, G3H, G3L, G6A, G6A plus, G9L			S0108B-L	635171084	Adult Finger Clip, 10ft(3m)	/	C0
			S0108C-L	635211084	Pediatric Finger Clip, 10ft(3m)		D2
			S0108D-L	635121084	Adult Silicone Soft, 10ft(3m)		D2
			S0108P-L	635221084	Pediatric Silicone Soft, 10ft(3m)		D2
			S0108F-L	635431084	Neonate Silicone Wrap, 10ft(3m)		D2
			S0108I-L	635191084	Multi-site Y, 10ft(3m)		D2
			S0108G-L	635141084	Adult Ear Clip, 10ft(3m)		D2
G1B			S0108B-S	635171082	Adult Finger Clip, 3ft(0.9m)	/	C0
			S0108C-S	635211082	Pediatric Finger Clip, 3ft(0.9m)		D2
			S0108D-S	635121082	Adult Silicone Soft, 3ft(0.9m)		D2
			S0108P-S	635221082	Pediatric Silicone Soft, 3ft(0.9m)		D2
			S0108F-S	635431082	Neonate Silicone Wrap, 3ft(0.9m)		D2
			S0108I-S	635191086	Multi-site Y, 4ft(1.2m)		D2
			S0108G-S	635141082	Adult Ear Clip, 3ft(0.9m)		D2
<b>Compatible GE Marquette</b>							
Eagle 1000/3000/4000 Dash 2000/3000/4000 Solar 8000/8000M i/9500(Tram 451/451N /851/851N) Cardiolab/Mac-Lab, Corometrics 120/2120 (Tram 451/451N) Responder 3000 (OxiSmart) (Non-oximax)			S0010B-S	635170102	Adult Finger Clip, 3ft(0.9m)	Need S0002NE-L 2006644-001 Instrument Connector: 	B5
			S0010C-S	635210102	Pediatric Finger Clip, 3ft(0.9m)		C4
			S0010D-S	635120102	Adult Silicone Soft, 3ft(0.9m)		C4
			S0010P-S	635220102	Pediatric Silicone Soft, 3ft(0.9m)		C4
			S0010F-S	635430102	Neonate Silicone Wrap, 3ft(0.9m)		C4
			S0010I-S	635190106	Multi-site Y, 4ft(1.2m)		C4
			S0010G-S	635140102	Adult Ear Clip, 3ft(0.9m)		C4
			S0002B-L	635170024	Adult Finger Clip, 10ft(3m)	/	B5
			S0002C-L	635210024	Pediatric Finger Clip, 10ft(3m)		C4
			S0002D-L	635120024	Adult Silicone Soft, 10ft(3m)		C4
			S0002P-L	635220024	Pediatric Silicone Soft, 10ft(3m)		C4
			S0002F-L	635430024	Neonate Silicone Wrap, 10ft(3m)		C4
			S0002I-L	635190024	Multi-site Y, 10ft(3m)		C4
			S0002G-L	635140024	Adult Ear Clip, 10ft(3m)		C4
Dash 3000,4000, 5000 Solar 8000/8000M i/9500 (Tram 450.915M, 850.915M) Cardiolab/Mac-Lab (Tram 450.915M) Corometrics 259 (Masimo tech)			S0025B-L	635170254	Adult Finger Clip, 10ft(3m)	/	C0
			S0025C-L	635210254	Pediatric Finger Clip, 10ft(3m)		D2
			S0025D-L	635120254	Adult Silicone Soft, 10ft(3m)		D2
			S0025P-L	635220254	Pediatric Silicone Soft, 10ft(3m)		D2
			S0025F-L	635430254	Neonate Silicone Wrap, 10ft(3m)		D2
			S0025I-L	635190254	Multi-site Y, 10ft(3m)		D2
			S0025G-L	635140254	Adult Ear Clip, 10ft(3m)		D2

OEM Manufacturer & Models	Instrument Connector	OEM#	Old Order Code	New Order Code	Descriptions	Adapter Cable	Price
<b>Compatible GE Marquette</b>							
Dash2500/ Dash 3000/ 4000/5000 Solar 8000/ 8000M i/9500 (Tram 451N5/ 851N5) Corometrics 250 (GE-Oxi tech)		DS100A	S0026B-S	635170262	Adult Finger Clip,3ft(0.9m)	Need S0122OX-L 2021406-001 Instrument Connector:	C2
			S0026C-S	635210262	Pediatric Finger Clip,3ft(0.9m)		C2
			S0026D-S	635120262	Adult Silicone Soft,3ft(0.9m)		D5
			S0026P-S	635220262	Pediatric Silicone Soft,3ft(0.9m)	Sensor Connector:	D5
			S0026F-S	635430262	Neonate Silicone Wrap, 3ft(0.9m)		D5
		D-YS	S0026I-S	635190266	Multi-site Y, 4ft(1.2m)		D5
			S0026G-S	635140262	Adult Ear Clip, 3ft(0.9m)	D5	
			S0122B-L	635171224	Adult Finger Clip,10ft(3m)	/	E0
			S0122C-L	635211224	Pediatric Finger Clip,10ft(3m)		E0
			S0122D-I	635121224	Adult Silicone Soft,10ft(3m)		F5
			S0122P-1	635221224	Pediatric Silicone Soft,10ft(3m)		F5
			S0122F-L	635431224	Neonate Silicone Wrap, 10ft(3m)		F5
			S0122I-L	635191224	Multi-site Y, 10ft(3m)		F5
			S0122G-L	635141224	Adult Ear Clip, 10ft(3m)		F5
<b>Compatible GE Trusignal</b>							
	TS-F-D	S0190B-S	635171902	Adult Finger Clip,3ft(0.9m)	Need / E.g S0190TS-L Depending on the instrument's SpO2 connector Instrument Connector:	C5	
		S0190C-S	635211902	Pediatric Finger Clip,3ft(0.9m)		D0	
	TS-SA-D	S0190D-S	635121902	Adult Silicone Soft,3ft(0.9m)		D0	
		S0190P-S	635221902	Pediatric Silicone Soft,3ft(0.9m)		D0	
		S0190E-S	635321902	Infant Silicone Soft, 3ft (0.9m)		D0	
		S0190F-S	635431902	Neonate Silicone Wrap, 3ft(0.9m)		D0	
		S0190I-S	635191906	Multi-site Y, 4ft(1.2m)		D0	
	S0190G-S	635141902	Adult Ear Clip, 3ft(0.9m)		D0		
<b>Compatible Guoteng (China), Also Compatible See Nellcor</b>							
GT3000, GT5000, GT6000 GT7000, GT9000, GT9002 PUAO: DPJ-300			S0024B-L	635170244	Adult Finger Clip,10ft(3m)	/	C0
			S0024C-L	635210244	Pediatric Finger Clip,10ft(3m)		D2
			S0024D-L	635120244	Adult Silicone Soft,10ft(3m)		D2
			S0024P-L	635220244	Pediatric Silicone Soft,10ft(3m)		D2
			S0024F-L	635430244	Neonate Silicone Wrap, 10ft(3m)		D2
			S0024I-L	635190244	Multi-site Y, 10ft(3m)		D2
			S0024G-L	635140244	Adult Ear Clip, 10ft(3m)		D2









OEM Manufacturer & Models	Instrument Connector	OEM#	Old Order Code	New Order Code	Descriptions	Adapter Cable	Price		
<b>Compatible Goldway (China)</b>									
UT6000A G3 (Philips tech)			S0015B-S	635170152	Adult Finger Clip,3ft(0.9m)	Need S0015PH-L Instrument Connector:	C0		
			S0015C-S	635210152	Pediatric Finger Clip,3ft(0.9m)		D2		
			S0015D-S	635120152	Adult Silicone Soft,3ft(0.9m)		D2		
			S0015P-S	635220152	Pediatric Silicone Soft,3ft(0.9m)	Sensor Connector:	D2		
			S0015E-S	635320152	Infant Silicone Soft, 3ft (0.9m)		D2		
			S0015F-S	635430152	Neonate Silicone Wrap, 3ft(0.9m)		D2		
			S0015I-S	635190156	Multi-site Y, 4ft(1.2m)	D2			
			S0015G-S	635140152	Adult Ear Clip, 3ft(0.9m)	D2			
			S0015B-L	635170154	Adult Finger Clip,10ft(3m)	/	C0		
			S0015C-L	635210154	Pediatric Finger Clip,10ft(3m)		D2		
			S0015D-L	635120154	Adult Silicone Soft,10ft(3m)		D2		
			S0015P-L	635220154	Pediatric Silicone Soft,10ft(3m)		D2		
			S0015E-L	635320154	Infant Silicone Soft, 10ft (3m)		D2		
			S0015F-I	635430154	Neonate Silicone Wrap, 10ft(3m)		D2		
			S0015I-L	635190154	Multi-site Y, 10ft(3m)		D2		
			S0015G-L	635140154	Adult Ear Clip, 10ft(3m)		D2		
		GOLDWAY: UT4000A, UT4000C, UT4000B, UT4000F, UT4000ACS (OxiSmart) (Non-oximax) PACE TECH			S0007B-L	635170074	Adult Finger Clip,10ft(3m)	/	C0
					S0007C-L	635210074	Pediatric Finger Clip,10ft(3m)		D2
	S0007D-L			635120074	Adult Silicone Soft,10ft(3m)	D2			
	S0007P-L			635220074	Pediatric Silicone Soft,10ft(3m)	D2			
	S0007F-L			635430074	Neonate Silicone Wrap, 10ft(3m)	D2			
	S0007I-L			635190074	Multi-site Y, 10ft(3m)	D2			
	S0007G-L			635140074	Adult Ear Clip, 10ft(3m)	D2			
3100 (Digical tech)			S0160B-L	635171604	Adult Finger Clip,10ft(3m)	/	C0		
			S0160C-L	635211604	Pediatric Finger Clip,10ft(3m)		D2		
			S0160D-L	635121604	Adult Silicone Soft,10ft(3m)		D2		
			S0160P-L	635221604	Pediatric Silicone Soft,10ft(3m)		D2		
			S0160F-L	635431604	Neonate Silicone Wrap, 10ft(3m)		D2		
			S0160I-L	635191604	Multi-site Y, 10ft(3m)		D2		
			S0160G-L	635141604	Adult Ear Clip, 10ft(3m)		D2		

OEM Manufacturer & Models	Instrument Connector	OEM#	Old Order Code	New Order Code	Descriptions	Adapter Cable	Price
<b>Compatible Heyer Scalis</b>							
Heyer Scalis 12				635175174	Adult Finger Clip, 10ft(3m)	/	C0
				635215174	Pediatric Finger Clip, 10ft(3m)		D2
				635125174	Adult Silicone Soft, 10ft(3m)		D2
				635225174	Pediatric Silicone Soft, 10ft(3m)		D2
				635435174	Neonate Silicone Wrap, 10ft(3m)		D2
				635195174	Multi-site Y, 10ft(3m)		D2
				635145174	Adult Ear Clip, 10ft(3m)		D2
<b>Compatible Infinium</b>							
				635171714	Adult Finger Clip, 10ft(3m)	/	C0
				635211714	Pediatric Finger Clip, 10ft(3m)		D2
				635121714	Adult Silicone Soft, 10ft(3m)		D2
				635221714	Pediatric Silicone Soft, 10ft(3m)		D2
				635431714	Neonate Silicone Wrap, 10ft(3m)		D2
				635191714	Multi-site Y, 10ft(3m)		D2
				635141714	Adult Ear Clip, 10ft(3m)		D2
<b>Compatible IVY</b>							
Vital-Guard 450CN(M) (Masimo tech)		2053	S0442B-L	635174424	Adult Finger Clip, 10ft(3m)	/	D0
			S0442C-L	635214424	Pediatric Finger Clip, 10ft(3m)		D0
			S0442D-L	635124424	Adult Silicone Soft, 10ft(3m)		D0
			S0442P-L	635224424	Pediatric Silicone Soft, 10ft(3m)		D0
			S0442E-L	635324424	Infant Silicone Soft, 10ft (3m)		D0
			S0442F-L	635434424	Neonate Silicone Wrap, 10ft(3m)		D0
			S0442J-L	635194424	Multi-site Y, 10ft(3m)		D0
			S0442G-L	635144424	Adult Ear Clip, 10ft(3m)		D0
			635184422	Adult Silicone ring type, 3ft (0.9m)	D0		
			S0442B-S	635174422	Adult Finger Clip, 3ft(0.9m)	Need S0442CS-L Instrument Connector: 	C0
			S0442C-S	635214422	Pediatric Finger Clip, 3ft(0.9m)		C0
			S0442D-S	635124422	Adult Silicone Soft, 3ft(0.9m)		C0
			S0442P-S	635224422	Pediatric Silicone Soft, 3ft(0.9m)		C0
			S0442E-S	635324422	Infant Silicone Soft, 3ft (0.9m)		Sensor Connector: C0
			S0442F-S	635434422	Neonate Silicone Wrap, 3ft(0.9m)		C0
			S0442I-S	635194422	Multi-site Y, 4ft(1.2m)		C0
		S0442G-S	635144422	Adult Ear Clip, 3ft(0.9m)	 C0		

OEM Manufacturer & Models	Instrument Connector	OEM#	Old Order Code	New Order Code	Descriptions	Adapter Cable	Price
<b>Compatible KEMP (China)</b>							
KP-900C/900B			S0090B-L	635170904	Adult Finger Clip, 10ft(3m)	/	C0
			S0090C-L	635210904	Pediatric Finger Clip, 10ft(3m)		D2
			S0090D-L	635120904	Adult Silicone Soft, 10ft(3m)		D2
			S0090P-L	635220904	Pediatric Silicone Soft, 10ft(3m)		D2
			S0090F-L	635430904	Neonate Silicone Wrap, 10ft(3m)		D2
			S0090I-L	635190904	Multi-site Y, 10ft(3m)		D2
	S0090G-L	635140904	Adult Ear Clip, 10ft(3m)	D2			
<b>Compatible Kontron</b>							
Kontron: 7138, 7840, 7845, Minimon7137, 7337 Micromon, Supermon, Kolomon, Trakmon original cable number 0608010 (OxiSmart) (Non-oximax)			S0019B-L	635170194	Adult Finger Clip, 10ft(3m)	/	B3
			S0019C-L	635210194	Pediatric Finger Clip, 10ft(3m)		B5
			S0019D-L	635120194	Adult Silicone Soft, 10ft(3m)		B5
			S0019P-L	635220194	Pediatric Silicone Soft, 10ft(3m)		B5
			S0019F-L	635430194	Neonate Silicone Wrap, 10ft(3m)		B5
			S0019I-L	635190194	Multi-site Y, 10ft(3m)		B5
	S0019G-L	635140194	Adult Ear Clip, 10ft(3m)	B5			
<b>Compatible Kernel</b>							
Kernel KN-601B 				535170494	Adult finger Clip, 6pin, 3M	/	C0
<b>Compatible Masimo Tech</b>							
Pronto-7, Rad-5, Rad-57, Rad-8, Rad-87, Radical-7GE: Pro 1000, Pro 300V2, ProCare 300 Datascope: Accutor V, Accutorr Plus, Passport 2 Medtronic: Lifepak 11, Lifepak 12, Lifepak 15		2387 (DC-8)DC-12, 1969 (LNOP) DCI-DC12	S0020B-L	635170204	Adult Finger Clip, 10ft(3m)	/	D0
			S0020C-L	635210204	Pediatric Finger Clip, 10ft(3m)		E5
			S0020D-L	635120204	Adult Silicone Soft, 10ft(3m)		E5
			S0020P-L	635220204	Pediatric Silicone Soft, 10ft(3m)		E5
			S0020F-L	635430204	Neonate Silicone Wrap, 10ft(3m)		E5
			S0020I-L	635190204	Multi-site Y, 10ft(3m)		E5
Accutor plus (Compatible Masimo Tech)		1863	S0204B-L	635172042	Adult Finger Clip, 10ft(3m)	Need Cable and Adapter: S0442CS-L +S0153CS-A	
			S0204C-L	635212042	Pediatric Finger Clip, 10ft(3m)		
			S0204D-L	635122042	Adult Silicone Soft, 10ft(3m)		
			S0204P-L	635222042	Pediatric Silicone Soft, 10ft(3m)		
			S0204F-L	635432042	Neonate Silicone Wrap, 10ft(3m)		
		2258 LNCS Y-I	S0204I-L	635192042	Multi-site Y, 10ft(3m)		
			S0204G-L	635142042	Adult Ear Clip, 10ft(3m)		
			S0204E-L	635322042	Infant Silicone Soft, 10ft(3m)		
Rad-8 Rad-5/Rad-5v SatShare		1269 LNOP DCI	S0020B-S	635170202	Adult Finger Clip, 3ft(0.9m)	Need Depending on the instrument's SpO2 connector 	C0
			S0020C-S	635210202	Pediatric Finger Clip, 3ft(0.9m)		D2
			S0020D-S	635120202	Adult Silicone Soft, 3ft(0.9m)		D2
			S0020P-S	635220202	Pediatric Silicone Soft, 3ft(0.9m)		D2
			S0020F-S	635430202	Neonate Silicone Wrap, 3ft(0.9m)		D2
			S0020I-S	635190202	Multi-site Y, 4ft(1.2m)		D2
	S0020G-S	635140202	Adult Ear Clip, 3ft(0.9m)	D2			











OEM Manufacturer & Models	Instrument Connector	OEM#	Old Order Code	New Order Code	Descriptions	Adapter Cable	Price
<b>Compatible Masimo Tech</b>							
Masimo RD Set Pronto-7, Rad-5, Rad-57, Rad-8, Rad-87, Radical-7		4050		635174502	Adult Finger Clip,3ft(0.9m)	 Need Depending on the instrument's SpO2 connector	D2
		4051		635214502	Pediatric Finger Clip,3ft(0.9m)		D2
				635124502	Adult Silicone Soft,3ft(0.9m)		D2
				635224502	Pediatric Silicone Soft,3ft(0.9m)		D2
				635324502	Infant Silicone Soft, 3ft (0.9m)		D2
				635434502	Neonate Silicone Wrap, 3ft(0.9m)		D2
		4054		635194506	Multi-site Y, 4ft(1.2m)		D2
		4053		635144502	Adult Ear Clip, 3ft(0.9m)		D2
		635194502	Multi-site, Y Type, 1pin, 3ft(0.9m)	D2			
Masimo SET Pronto-7, Rad-5, Rad-57, Rad-8, Rad-87, Radical-7		2053	S0442B-L	635174424	Adult Finger Clip,10ft(3m)	/	D0
			S0442C-L	635214424	Pediatric Finger Clip,10ft(3m)		D0
			S0442D-L	635124424	Adult Silicone Soft,10ft(3m)		D0
			S0442P-L	635224424	Pediatric Silicone Soft,10ft(3m)		D0
			S0442E-L	635324424	Infant Silicone Soft, 10ft (3m)		D0
			S0442F-L	635434424	Neonate Silicone Wrap, 10ft(3m)		D0
			S0442I-L	635194424	Multi-site Y, 10ft(3m)		D0
			S0442G-L	635144424	Adult Ear Clip, 10ft(3m)		D0
		635184426	Adult Silicone ring type, 3ft (0.9m)	D0			
Masimo LNCS Rad-5, Rad-6, Rad-7, Rad-8, Rad-57			S0442B-S	635174422	Adult Finger Clip,3ft(0.9m)	 Need S0442CS-L Instrument Connector:  Sensor Connector: 	C0
			S0442C-S	635214422	Pediatric Finger Clip,3ft(0.9m)		C0
			S0442D-S	635124422	Adult Silicone Soft,3ft(0.9m)		C0
			S0442P-S	635224422	Pediatric Silicone Soft,3ft(0.9m)		C0
			S0442E-S	635324422	Infant Silicone Soft, 3ft (0.9m)		C0
			S0442F-S	635434422	Neonate Silicone Wrap, 3ft(0.9m)		C0
			S0442I-S	635194426	Multi-site Y, 4ft(1.2m)		C0
			S0442G-S	635144422	Adult Ear Clip, 3ft(0.9m)		C0
Masimo M-LNCS Radical-7; Rad-87; Rad-8				635175402	Adult Finger Clip,3ft(0.9m)	Need S0540MS-L	D2
				635215402	Pediatric Finger Clip,3ft(0.9m)		D2
				635125402	Adult Silicone Soft,3ft(0.9m)		D2
				635225402	Pediatric Silicone Soft,3ft(0.9m)		D2
				635325402	Infant Silicone Soft, 3ft (0.9m)		D2
				635435402	Neonate Silicone Wrap, 3ft(0.9m)		D2
				635195406	Multi-site Y, 4ft(1.2m)		D2
				635145402	Adult Ear Clip, 3ft(0.9m)		D2

OEM Manufacturer & Models	Instrument Connector	OEM#	Old Order Code	New Order Code	Descriptions	Adapter Cable	Price
<b>Compatible MDE/Invivo</b>							
Escort 1 Escort 300 (OxiSmart) (Non-oximax)			S0010B-S	635170102	Adult Finger Clip,3ft(0.9m)	Need Temporarily Unavailable	B5
			S0010C-S	635210102	Pediatric Finger Clip,3ft(0.9m)		C4
			S0010D-S	635120102	Adult Silicone Soft,3ft(0.9m)		C4
			S0010P-S	635220102	Pediatric Silicone Soft,3ft(0.9m)		C4
			S0010F-S	635430102	Neonate Silicone Wrap, 3ft(0.9m)		C4
			S0010I-S	635190106	Multi-site Y, 4ft(1.2m)		C4
			S0010G-S	635140102	Adult Ear Clip, 3ft(0.9m)		C4
Millenia, Escort, (M) M10TM, M12TM, M8TM (Masimo tech)		2053	S0442B-L	635174424	Adult Finger Clip,10ft(3m)	/	D0
			S0442C-L	635214424	Pediatric Finger Clip,10ft(3m)		D0
			S0442D-L	635124424	Adult Silicone Soft,10ft(3m)		D0
			S0442P-L	635224424	Pediatric Silicone Soft,10ft(3m)		D0
			S0442E-L	635324424	Infant Silicone Soft, 10ft (3m)		D0
			S0442F-L	635434424	Neonate Silicone Wrap, 10ft(3m)		D0
			S0442I-L	635194424	Multi-site Y, 10ft(3m)		D0
			S0442G-L	635144424	Adult Ear Clip, 10ft(3m)		D0
			635184426	Adult Silicone ring type, 3ft (0.9m)	D0		
			S0442B-S	635174422	Adult Finger Clip,3ft(0.9m)	Need S0442CS-L Instrument Connector:  Sensor Connector: 	C0
			S0442C-S	635214422	Pediatric Finger Clip,3ft(0.9m)		C0
			S0442D-S	635124422	Adult Silicone Soft,3ft(0.9m)		C0
			S0442P-S	635224422	Pediatric Silicone Soft,3ft(0.9m)		C0
			S0442E-S	635324422	Infant Silicone Soft, 3ft (0.9m)		C0
			S0442F-S	635434422	Neonate Silicone Wrap, 3ft(0.9m)		C0
		S0442I-S	635194426	Multi-site Y, 4ft(1.2m)	C0		
	S0442G-S	635144422	Adult Ear Clip, 3ft(0.9m)	C0			
<b>Compatible MDE/Invivo (MASIMO module)</b>							
Invivo 3500			S0094B-L	635170944	Adult Finger Clip,10ft(3m)	/	C0
			S0094C-L	635210944	Pediatric Finger Clip,10ft(3m)		D2
			S0094D-L	635120944	Adult Silicone Soft,10ft(3m)		D2
			S0094P-L	635220944	Pediatric Silicone Soft,10ft(3m)		D2
			S0094F-L	635430944	Neonate Silicone Wrap, 10ft(3m)		D2
			S0094I-L	635190944	Multi-site Y, 10ft(3m)		D2
			S0094G-L	635140944	Adult Ear Clip, 10ft(3m)		D2

OEM Manufacturer & Models	Instrument Connector	OEM#	Old Order Code	New Order Code	Descriptions	Adapter Cable	Price	
<b>Compatible MDE/Invivo (MASIMO module)</b>								
4500, M8, Omni Track, Omeg, 1445 Millennia (Masimo tech)		2053	S0442B-L	635174424	Adult Finger Clip, 10ft(3m)	/	D0	
			S0442C-L	635214424	Pediatric Finger Clip, 10ft(3m)		D0	
			S0442D-L	635124424	Adult Silicone Soft, 10ft(3m)		D0	
			S0442P-L	635224424	Pediatric Silicone Soft, 10ft(3m)		D0	
			S0442E-L	635324424	Infant Silicone Soft, 10ft (3m)		D0	
			S0442F-L	635434424	Neonate Silicone Wrap, 10ft(3m)		D0	
			S0442I-L	635194424	Multi-site Y, 10ft(3m)		D0	
			S0442G-L	635144424	Adult Ear Clip, 10ft(3m)		D0	
				635184426	Adult Silicone ring type, 3ft (0.9m)	D0		
				S0442B-S	635174422	Adult Finger Clip, 3ft(0.9m)	Need S0442CS-L Instrument Connector:  Sensor Connector: 	C0
				S0442C-S	635214422	Pediatric Finger Clip, 3ft(0.9m)		C0
				S0442D-S	635124422	Adult Silicone Soft, 3ft(0.9m)		C0
				S0442P-S	635224422	Pediatric Silicone Soft, 3ft(0.9m)		C0
				S0442E-S	635324422	Infant Silicone Soft, 3ft (0.9m)		C0
				S0442F-S	635434422	Neonate Silicone Wrap, 3ft(0.9m)		C0
				S0442I-S	635194426	Multi-site Y, 4ft(1.2m)		C0
			S0442G-S	635144422	Adult Ear Clip, 3ft(0.9m)	C0		
<b>Compatible Medtronic</b>								
LIFEPAK 12, 15, 20(M) (Masimo tech)		2053	S0442B-L	635174424	Adult Finger Clip, 10ft(3m)		D0	
			S0442C-L	635214424	Pediatric Finger Clip, 10ft(3m)		D0	
			S0442D-L	635124424	Adult Silicone Soft, 10ft(3m)		D0	
			S0442P-L	635224424	Pediatric Silicone Soft, 10ft(3m)		D0	
			S0442E-L	635324424	Infant Silicone Soft, 10ft (3m)		D0	
			S0442F-L	635434424	Neonate Silicone Wrap, 10ft(3m)		D0	
			S0442I-L	635194424	Multi-site Y, 10ft(3m)		D0	
			S0442G-L	635144424	Adult Ear Clip, 10ft(3m)		D0	
				635184426	Adult Silicone ring type, 3ft (0.9m)	D0		
				S0442B-S	635174422	Adult Finger Clip, 3ft(0.9m)	Need S0442CS-L Instrument Connector:  Sensor Connector: 	C0
				S0442C-S	635214422	Pediatric Finger Clip, 3ft(0.9m)		C0
				S0442D-S	635124422	Adult Silicone Soft, 3ft(0.9m)		C0
				S0442P-S	635224422	Pediatric Silicone Soft, 3ft(0.9m)		C0
				S0442E-S	635324422	Infant Silicone Soft, 3ft (0.9m)		C0
				S0442F-S	635434422	Neonate Silicone Wrap, 3ft(0.9m)		C0
				S0442I-S	635194426	Multi-site Y, 4ft(1.2m)		C0
			S0442G-S	635144422	Adult Ear Clip, 3ft(0.9m)	C0		

OEM Manufacturer & Models	Instrument Connector	OEM#	Old Order Code	New Order Code	Descriptions	Adapter Cable	Price
<b>Compatible Medtronic</b>							
LIFEPAK 12 (OxiSmart) (Non-oximax)			S0010B-S	635170102	Adult Finger Clip,3ft(0.9m)	Need S0010NE-L Instrument Connector:	B5
			S0010C-S	635210102	Pediatric Finger Clip,3ft(0.9m)		C4
			S0010D-S	635120102	Adult Silicone Soft,3ft(0.9m)		C4
			S0010P-S	635220102	Pediatric Silicone Soft,3ft(0.9m)		C4
			S0010F-S	635430102	Neonate Silicone Wrap, 3ft(0.9m)	Sensor Connector:	C4
			S0010I-S	635190102	Multi-site Y, 4ft(1.2m)		C4
			S0010G-S	635140102	Adult Ear Clip, 3ft(0.9m)		C4
<b>Compatible MEK (Korea)</b>							
MP-100, MP110, MP400, MP500, MP600, MP1000 (CSI Module)			S0018B-L	635170184	Adult Finger Clip,10ft(3m)	/	C0
			S0018C-L	635210184	Pediatric Finger Clip,10ft(3m)		D2
			S0018D-L	635120184	Adult Silicone Soft,10ft(3m)		D2
			S0018P-L	635220184	Pediatric Silicone Soft,10ft(3m)		D2
			S0018F-L	635430184	Neonate Silicone Wrap, 10ft(3m)		D2
			S0018I-L	635190184	Multi-site Y, 10ft(3m)		D2
			S0018G-L	635140184	Adult Ear Clip, 10ft(3m)	D2	
			S0018B-S	635170182	Adult Finger Clip,3ft(0.9m)	/	C0
			S0018C-S	635210182	Pediatric Finger Clip,3ft(0.9m)		D2
			S0018D-S	635120182	Adult Silicone Soft,3ft(0.9m)		D2
			S0018P-S	635220182	Pediatric Silicone Soft,3ft(0.9m)		D2
			S0018F-S	635430182	Neonate Silicone Wrap, 3ft(0.9m)		D2
			S0018I-S	635190186	Multi-site Y, 4ft(1.2m)		D2
	S0018G-S	635140182	Adult Ear Clip, 3ft(0.9m)	D2			
MP1000 (OxiSmart) (Non-oximax) (Nellcor Module)			S0144B-L	635171444	Adult Finger Clip,10ft(3m)	/	D0
			S0144C-L	635211444	Pediatric Finger Clip,10ft(3m)		E2
			S0144D-L	635121444	Adult Silicone Soft,10ft(3m)		E2
			S0144P-L	635221444	Pediatric Silicone Soft,10ft(3m)		E2
			S0144F-L	635431444	Neonate Silicone Wrap, 10ft(3m)		E2
			S0144I-L	635191444	Multi-site Y, 10ft(3m)		E2
	S0144G-L	635141444	Adult Ear Clip, 10ft(3m)	E2			
MP1000 (OxiSmart) (Non-oximax) (Nellcor Module)			S0010B-S	635170102	Adult Finger Clip,3ft(0.9m)	Need S0144NE-L Instrument Connector:	B5
			S0010C-S	635210102	Pediatric Finger Clip,3ft(0.9m)		C4
			S0010D-S	635120102	Adult Silicone Soft,3ft(0.9m)		C4
			S0010P-S	635220102	Pediatric Silicone Soft,3ft(0.9m)		C4
			S0010F-S	635430102	Neonate Silicone Wrap, 3ft(0.9m)	Sensor Connector:	C4
			S0010I-S	635190106	Multi-site Y, 4ft(1.2m)		C4
			S0010G-S	635140102	Adult Ear Clip, 3ft(0.9m)		C4

OEM Manufacturer & Models	Instrument Connector	OEM#	Old Order Code	New Order Code	Descriptions	Adapter Cable	Price
<b>Compatible Mennen Medical</b>							
Envoy (OxiSmart) (Non-oximax)			S0010B-S	635170102	Adult Finger Clip,3ft(0.9m)	Need S0103NE-L Instrument Connector:	B5
			S0010C-S	635210102	Pediatric Finger Clip,3ft(0.9m)		C4
			S0010D-S	635120102	Adult Silicone Soft,3ft(0.9m)		C4
			S0010P-S	635220102	Pediatric Silicone Soft,3ft(0.9m)	Sensor Connector:	C4
			S0010F-S	635430102	Neonate Silicone Wrap, 3ft(0.9m)		C4
			S0010I-S	635190106	Multi-site Y, 4ft(1.2m)		C4
			S0010G-S	635140102	Adult Ear Clip, 3ft(0.9m)		C4
Horizon 1100, 2000XL Mercury, MR1300 (OxiSmart) (Non-oximax)			S0010B-S	635170102	Adult Finger Clip,3ft(0.9m)	Need Temporarily Unavailable	B5
			S0010C-S	635210102	Pediatric Finger Clip,3ft(0.9m)		C4
			S0010D-S	635120102	Adult Silicone Soft,3ft(0.9m)		C4
			S0010P-S	635220102	Pediatric Silicone Soft,3ft(0.9m)		C4
			S0010F-S	635430102	Neonate Silicone Wrap, 3ft(0.9m)		C4
			S0010I-S	635190106	Multi-site Y, 4ft(1.2m)		C4
			S0010G-S	635140102	Adult Ear Clip, 3ft(0.9m)		C4
Horizon XL, Mercury 1200, MR1300 (OxiSmart) (Non-oximax)			S0010B-S	635170102	Adult Finger Clip,3ft(0.9m)	Need S0009NE-L Instrument Connector:	B5
			S0010C-S	635210102	Pediatric Finger Clip,3ft(0.9m)		C4
			S0010D-S	635120102	Adult Silicone Soft,3ft(0.9m)		C4
			S0010P-S	635220102	Pediatric Silicone Soft,3ft(0.9m)	Sensor Connector:	C4
			S0010F-S	635430102	Neonate Silicone Wrap, 3ft(0.9m)		C4
			S0010I-S	635190106	Multi-site Y, 4ft(1.2m)		C4
			S0010G-S	635140102	Adult Ear Clip, 3ft(0.9m)		C4
Horizon XL (Ohmeda)			S0014B-L	635170144	Adult Finger Clip,10ft(3m)	/	C0
			S0014C-L	635210144	Pediatric Finger Clip,10ft(3m)		D2
			S0014D-L	635120144	Adult Silicone Soft,10ft(3m)		D2
			S0014P-L	635220144	Pediatric Silicone Soft,10ft(3m)		D2
			S0014E-L	635320144	Infant Silicone Soft, 10ft (3m)		D2
			S0014F-L	635430144	Neonate Silicone Wrap, 10ft(3m)		D2
			S0014I-L	635190144	Multi-site Y, 10ft(3m)		D2
			S0014G-L	635140144	Adult Ear Clip, 10ft(3m)		D2

OEM Manufacturer & Models	Instrument Connector	OEM#	Old Order Code	New Order Code	Descriptions	Adapter Cable	Price	
<b>Compatible Mennen Medical</b>								
Horizon, Envoy, Vitalogik (M) (Masimo tech)		2053	S0442B-L	635174424	Adult Finger Clip,10ft(3m)	/	D0	
			S0442C-L	635214424	Pediatric Finger Clip,10ft(3m)		D0	
			S0442D-L	635124424	Adult Silicone Soft,10ft(3m)		D0	
			S0442P-L	635224424	Pediatric Silicone Soft,10ft(3m)		D0	
			S0442E-L	635324424	Infant Silicone Soft, 10ft (3m)		D0	
			S0442F-L	635434424	Neonate Silicone Wrap, 10ft(3m)		D0	
			S0442I-L	635194424	Multi-site Y, 10ft(3m)		D0	
			S0442G-L	635144424	Adult Ear Clip, 10ft(3m)		D0	
			635184426	Adult Silicone ring type, 3ft (0.9m)	D0			
				S0442B-S	635174422	Adult Finger Clip,3ft(0.9m)	Need S0442CS-L Instrument Connector:	C0
			S0442C-S	635214422	Pediatric Finger Clip,3ft(0.9m)		C0	
			S0442D-S	635124422	Adult Silicone Soft,3ft(0.9m)	Sensor Connector:	C0	
			S0442P-S	635224422	Pediatric Silicone Soft,3ft(0.9m)		C0	
			S0442E-S	635324422	Infant Silicone Soft, 3ft (0.9m)	Sensor Connector:	C0	
	S0442F-S		635434422	Neonate Silicone Wrap, 3ft(0.9m)		C0		
	S0442I-S		635194426	Multi-site Y, 4ft(1.2m)	C0			
	S0442G-S	635144422	Adult Ear Clip, 3ft(0.9m)	C0				
<b>Compatible Medlab, See BCI</b>								
<b>Compatible Mindray (China)</b>								
PM-5000 PM 6000 PM-8000			S0045B-L	635170454	Adult Finger Clip,10ft(3m)		D0	
			S0045C-L	635210454	Pediatric Finger Clip,10ft(3m)		E2	
			S0045D-L	635120454	Adult Silicone Soft,10ft(3m)		E2	
			S0045P-L	635220454	Pediatric Silicone Soft,10ft(3m)		E2	
			S0045F-L	635430454	Neonate Silicone Wrap, 10ft(3m)		E2	
			S0045I-L	635190454	Multi-site Y, 10ft(3m)		E2	
			S0045G-L	635140454	Adult Ear Clip, 10ft(3m)		E2	
Compatible Masimo Tech			S0442B-S	635174422	Adult Finger Clip,3ft(0.9m)	Need S0442CS-L Instrument Connector:	C0	
			S0442C-S	635214422	Pediatric Finger Clip,3ft(0.9m)		C0	
			S0442D-S	635124422	Adult Silicone Soft,3ft(0.9m)	Sensor Connector:	C0	
			S0442P-S	635224422	Pediatric Silicone Soft,3ft(0.9m)		C0	
			S0442E-S	635324422	Infant Silicone Soft, 3ft (0.9m)	Sensor Connector:	C0	
			S0442F-S	635434422	Neonate Silicone Wrap, 3ft(0.9m)		C0	
			S0442I-S	635194426	Multi-site Y, 4ft(1.2m)	C0		
			S0442G-S	635144422	Adult Ear Clip, 3ft(0.9m)	C0		

OEM Manufacturer & Models	Instrument Connector	OEM#	Old Order Code	New Order Code	Descriptions	Adapter Cable	Price
<b>Compatible Mindray (China)</b>							
PM-9000, 9100, 9200, (PM-6201, 7000, 8000, M1K0, M2K0 before 2006) (Compatible Masimo Tech)			S0013B-L	635170134	Adult finger clip, 10ft(3m)	/	C0
			S0013C-L	635210134	Pediatric finger clip, 10ft(3m)		D2
			S0013D-L	635120134	Adult silicone soft, 10ft(3m)		D2
			S0013P-L	635220134	Pediatric silicone soft, 10ft(3m)		D2
			S0013F-L	635430134	Neonate silicone wrap, 10ft(3m)		D2
			S0013I-L	635190134	Multi-site Y, 10ft(3m)		D2
			S0013G-L	635140134	Adult ear clip, 10ft(3m)		D2
Compatible Masimo Tech			S0442B-S	635174422	Adult Finger Clip, 3ft (0.9m)	Need S0442CS-L Instrument Connector:	C0
			S0442C-S	635214422	Pediatric Finger Clip, 3ft (0.9m)		C0
			S0442D-S	635124422	Adult Silicone Soft, 3ft (0.9m)		C0
			S0442P-S	635224422	Pediatric Silicone Soft, 3ft (0.9m)	Sensor Connector:	C0
			S0442E-S	635324422	Infant Silicone Soft, 3ft (0.9m)		C0
			S0442F-S	635434422	Neonate Silicone Wrap, 3ft (0.9m)		C0
			S0442I-S	635194426	Multi-site Y, 4ft (1.2m)		C0
	S0442G-S	635144422	Adult Ear Clip, 3ft (0.9m)	C0			
PM9000 express (MASIMO). PM8002, 9201, (PM-6000, 6201, 7000, 8000, 9000, M1K0, M2K0 since 2006), T8			S0116B-L	635171164	Adult Finger Clip, 10ft(3m)	/	C0
			S0116C-L	635211164	Pediatric Finger Clip, 10ft(3m)		D2
			S0116D-L	635121164	Adult Silicone Soft, 10ft(3m)		D2
			S0116P-L	635221164	Pediatric Silicone Soft, 10ft(3m)		D2
			S0116F-L	635431164	Neonate Silicone Wrap, 10ft(3m)		D2
			S0116I-L	635191164	Multi-site Y, 10ft(3m)		D2
			S0116G-L	635141164	Adult Ear Clip, 10ft(3m)		D2
8002, 9201, PM7000 (Since Jan. 2006) PM-8000series, PM-9000series, VS-800 (Oximax tech)			S0129B-L	635171294	Adult Finger Clip, 10ft(3m)	/	D3
			S0129C-L	635211294	Pediatric Finger Clip, 10ft(3m)		D5
			S0129D-L	635121294	Adult Silicone Soft, 10ft(3m)		D5
			S0129P-L	635221294	Pediatric Silicone Soft, 10ft(3m)		D5
			S0129F-L	635431294	Neonate Silicone Wrap, 10ft(3m)		D5
			S0129I-L	635191294	Multi-site Y, 10ft(3m)		D5
			S0129G-L	635141294	Adult Ear Clip, 10ft(3m)		D5
BeneVision, BeneView, iPM, iMEC, uMEC series (Mindray tech)			S0125B-L	635171254	Adult Finger Clip, 10ft(3m)	/	C0
			S0125C-L	635211254	Pediatric Finger Clip, 10ft(3m)		D2
			S0125D-L	635121254	Adult Silicone Soft, 10ft(3m)		D2
			S0125P-L	635221254	Pediatric Silicone Soft, 10ft(3m)		D2
			S0125F-L	635431254	Neonate Silicone Wrap, 10ft(3m)		D2
			S0125I-L	635191254	Multi-site Y, 10ft(3m)		D2
			S0125G-L	635141254	Adult Ear Clip, 10ft(3m)		D2

OEM Manufacturer & Models	Instrument Connector	OEM#	Old Order Code	New Order Code	Descriptions	Adapter Cable	Price
<b>Compatible Mindray (China)</b>							
iMEC, uMEC series (Masimo SET tech)		512F(115-012807-00)	S0126B-L	635171264	Adult Finger Clip,10ft(3m)	/	C0
			S0126C-L	635211264	Pediatric Finger Clip,10ft(3m)		D2
			S0126D-L	635121264	Adult Silicone Soft,10ft(3m)		D2
			S0126P-L	635221264	Pediatric Silicone Soft,10ft(3m)		D2
		518B(115-020887-00)	S0126F-L	635431264	Neonate Silicone Wrap, 10ft(3m)		D2
			S0126I-L	635191264	Multi-site Y, 10ft(3m)		D2
DPM6/7, Accutorr 3/7/8, Passport 12/ 12M/17M,T1 (Masimo Rainbow tech)			S0199B-L	635171994	Adult Finger Clip,10ft(3m)	/	D0
			S0199C-L	635211994	Pediatric Finger Clip,10ft(3m)		E2
			S0199D-L	635121994	Adult Silicone Soft,10ft(3m)		E2
			S0199P-L	635221994	Pediatric Silicone Soft,10ft(3m)		E2
			S0199F-L	635431994	Neonate Silicone Wrap, 10ft(3m)		E2
			S0199I-L	635191994	Multi-site Y, 10ft(3m)		E2
BeneView T5/T6/T8 iPM Series (Masimo tech)			S0442B-S	635174422	Adult Finger Clip,3ft(0.9m)	Need S0442CS-L Instrument Connector:	C0
			S0442C-S	635214422	Pediatric Finger Clip,3ft(0.9m)		C0
			S0442D-S	635124422	Adult Silicone Soft,3ft(0.9m)		C0
			S0442P-S	635224422	Pediatric Silicone Soft,3ft(0.9m)	Sensor Connector:	C0
			S0442E-S	635324422	Infant Silicone Soft, 3ft (0.9m)		C0
			S0442F-S	635434422	Neonate Silicone Wrap, 3ft(0.9m)		C0
			S0442I-S	635194426	Multi-site Y, 4ft(1.2m)	C0	
			S0442G-S	635144422	Adult Ear Clip, 3ft(0.9m)	C0	
Mindray: PM9000 (BCI module)			S0007B-L	635170074	Adult Finger Clip,10ft(3m)	/	C0
			S0007C-L	635210074	Pediatric Finger Clip,10ft(3m)		D2
			S0007D-L	635120074	Adult Silicone Soft,10ft(3m)		D2
			S0007P-L	635220074	Pediatric Silicone Soft,10ft(3m)		D2
			S0007F-L	635430074	Neonate Silicone Wrap, 10ft(3m)		D2
			S0007I-L	635190074	Multi-site Y, 10ft(3m)		D2
			S0007G-L	635140074	Adult Ear Clip, 10ft(3m)		D2
509B, MEC-1000, MEC-1200 New PM6000 PM7000/ 8000/9000, VS 800, PM600 PM9000 Express (Mindray tech)			S0040B-L	635170404	Adult Finger Clip,10ft(3m)	/	C0
			S0040C-L	635210404	Pediatric Finger Clip,10ft(3m)		D2
			S0040D-L	635120404	Adult Silicone Soft,10ft(3m)		D2
			S0040P-L	635220404	Pediatric Silicone Soft,10ft(3m)		D2
			S0040F-L	635430404	Neonate Silicone Wrap, 10ft(3m)		D2
			S0040I-L	635190404	Multi-site Y, 10ft(3m)		D2
			S0040G-L	635140404	Adult Ear Clip, 10ft(3m)		D2

OEM Manufacturer & Models	Instrument Connector	OEM#	Old Order Code	New Order Code	Descriptions	Adapter Cable	Price
<b>Compatible MEC, Sunmind (China)</b>							
KP-9000, KP-930/930F			S0010B-S	635170102	Adult Finger Clip,3ft(0.9m)	Need S0141NE-L Instrument Connector:	B5
			S0010C-S	635210102	Pediatric Finger Clip,3ft(0.9m)		C4
			S0010D-S	635120102	Adult Silicone Soft,3ft(0.9m)	C4	
			S0010P-S	635220102	Pediatric Silicone Soft,3ft(0.9m)	 C4	
			S0010F-S	635430102	Neonate Silicone Wrap, 3ft(0.9m)	Sensor Connector: C4	
			S0010I-S	635190106	Multi-site Y, 4ft(1.2m)	C4	
			S0010G-S	635140102	Adult Ear Clip, 3ft(0.9m)	 C4	
<b>Compatible M&amp;B (China)</b>							
CD2000 OxiSmart (Non-oximax)			S0010B-S	635170102	Adult Finger Clip,3ft(0.9m)	Need S0093NE-L Instrument Connector:	B5
			S0010C-S	635210102	Pediatric Finger Clip,3ft(0.9m)		C4
			S0010D-S	635120102	Adult Silicone Soft,3ft(0.9m)	C4	
			S0010P-S	635220102	Pediatric Silicone Soft,3ft(0.9m)	 C4	
			S0010F-S	635430102	Neonate Silicone Wrap, 3ft(0.9m)	Sensor Connector: C4	
			S0010I-S	635190106	Multi-site Y, 4ft(1.2m)	C4	
			S0010G-S	635140102	Adult Ear Clip, 3ft(0.9m)	 C4	
<b>Compatible Minolta (Konica)</b>							
PULSOX-300 PULSOX-300i		SR-5C	S0152B-S	635171522	Adult Finger Clip,3ft(0.9m)	/	C2
			S0152C-S	635211522	Pediatric Finger Clip,3ft(0.9m)		C3
		SR-5C	S0152D-S	635121522	Adult Silicone Soft,3ft(0.9m)		C3
			S0152P-S	635221522	Pediatric Silicone Soft,3ft(0.9m)		C3
			S0152F-S	635431522	Neonate Silicone Wrap, 3ft(0.9m)		C3
			S0152I-S	635191526	Multi-site Y, 4ft(1.2m)		C3
			S0152G-S	635141522	Adult Ear Clip, 3ft(0.9m)		C3
<b>Compatible Medlinket (China)</b>							
Philips: MP, MX series Mindray BeneView series Drager Delta, Kappa, Delta XL series GE DASH/ EAGLE series				635171632	Adult Finger Clip,3ft(0.9m)	/	C0
				635211632	Pediatric Finger Clip,3ft(0.9m)		D2
				635121632	Adult Silicone Soft,3ft(0.9m)		D2
				635221632	Pediatric Silicone Soft,3ft(0.9m)		D2
				635431632	Neonate Silicone Wrap, 3ft(0.9m)		D2
				635191636	Multi-site Y, 4ft(1.2m)		D2
							635141632
AM-806				635181626	Adult Silicone ring type, 0.7ft (0.2m)	/	C0

OEM Manufacturer & Models	Instrument Connector	OEM#	Old Order Code	New Order Code	Descriptions	Adapter Cable	Price
<b>Compatible Newtech (China)</b>							
Patient monitor (Digital Tech)			S0108B-L	635171084	Adult Finger Clip, 10ft(3m)	/	C0
			S0108C-L	635211084	Pediatric Finger Clip, 10ft(3m)		D2
			S0108D-L	635121084	Adult Silicone Soft, 10ft(3m)		D2
			S0108P-L	635221084	Pediatric Silicone Soft, 10ft(3m)		D2
			S0108F-L	635431084	Neonate Silicone Wrap, 10ft(3m)		D2
			S0108I-L	635191084	Multi-site Y, 10ft(3m)		D2
			S0108G-L	635141084	Adult Ear Clip, 10ft(3m)		D2
Pulse Oximer NT1A, NT1B, NT1D (Digital Tech)			S0108B-S	635171082	Adult Finger Clip, 3ft(0.9m)	/	C0
			S0108C-S	635211082	Pediatric Finger Clip, 3ft(0.9m)		D2
			S0108D-S	635121082	Adult Silicone Soft, 3ft(0.9m)		D2
			S0108P-S	635221082	Pediatric Silicone Soft, 3ft(0.9m)		D2
			S0108F-S	635431082	Neonate Silicone Wrap, 3ft(0.9m)		D2
			S0108I-S	635191086	Multi-site Y, 4ft(1.2m)		D2
			S0108G-S	635141082	Adult Ear Clip, 3ft(0.9m)		D2
<b>Compatible Nellcor</b>							
N550, N595, N560 (OxiSmart Tech.)		DOC10+ DS100A	S0117B-L	635171174	Adult Finger Clip, 10ft(3m)	/	E5
			S0117C-L	635211174	Pediatric Finger Clip, 10ft(3m)		E0
			S0117D-L	635121174	Adult Silicone Soft, 10ft(3m)		E0
			S0117P-L	635221174	Pediatric Silicone Soft, 10ft(3m)		E0
			S0117F-L	635431174	Neonate Silicone Wrap, 10ft(3m)		E0
			S0117I-L	635191174	Multi-site Y, 10ft(3m)		E0
			S0117G-L	635141174	Adult Ear Clip, 10ft(3m)		E0
N65 (Oximax tech)			S0433B-S	635174332	Adult Finger Clip, 3ft(0.9m)	/	C2
			S0433C-S	635214332	Pediatric Finger Clip, 3ft(0.9m)		C2
			S0433D-S	635124332	Adult Silicone Soft, 3ft(0.9m)		D5
			S0433P-S	635224332	Pediatric Silicone Soft, 3ft(0.9m)		D5
			S0433F-S	635434332	Neonate Silicone Wrap, 3ft(0.9m)		D5
			S0433I-S	635194336	Multi-site Y, 4ft(1.2m)		D5
			S0433G-S	635144332	Adult Ear Clip, 3ft(0.9m)		D5
			S0010B-S	635170102	Adult Finger Clip, 3ft(0.9m)	Need S0026NE-L Instrument Connector:	B5
			S0010C-S	635210102	Pediatric Finger Clip, 3ft(0.9m)		C4
			S0010D-S	635120102	Adult Silicone Soft, 3ft(0.9m)	Sensor Connector:	C4
			S0010P-S	635220102	Pediatric Silicone Soft, 3ft(0.9m)		C4
			S0010F-S	635430102	Neonate Silicone Wrap, 3ft(0.9m)		C4
			S0010I-S	635190106	Multi-site Y, 4ft(1.2m)		C4
			S0010G-S	635140102	Adult Ear Clip, 3ft(0.9m)		C4













OEM Manufacturer & Models	Instrument Connector	OEM#	Old Order Code	New Order Code	Descriptions	Adapter Cable	Price
<b>Compatible Nellcor</b>							
NPB3000-3100, Symphony, NPB-290, NPB-295, NPB-395 (OxiSmart Tech.)			S0010B-L	635170104	Adult Finger Clip, 10ft(3m)	/	B5
			S0010C-L	635210104	Pediatric Finger Clip, 10ft(3m)		C4
			S0010D-L	635120104	Adult Silicone Soft, 10ft(3m)		C4
			S0010P-L	635220104	Pediatric Silicone Soft, 10ft(3m)		C4
			S0010E-L	635320104	Infant Silicone Soft, 10ft (3m)		C4
			S0010F-L	635430104	Neonate Silicone Wrap, 10ft(3m)		C4
			S0010I-L	635190104	Multi-site Y, 10ft(3m)		C4
			S0010G-L	635140104	Adult Ear Clip, 10ft(3m)		C4
				635180102	Adult Silicone ring type, 3ft (0.9m)		C4
NPB 40, NPB20, NPB75 NPB 180, NPB 185, NPB-190, NPB-195, NPB 3900, NPB 4000 (OxiSmart Tech.)			S0010B-S	635170102	Adult Finger Clip, 3ft(0.9m)	Need S0010NE-L Instrument Connector:	B5
			S0010C-S	635210102	Pediatric Finger Clip, 3ft(0.9m)		C4
			S0010D-S	635120102	Adult Silicone Soft, 3ft(0.9m)		C4
			S0010P-S	635220102	Pediatric Silicone Soft, 3ft(0.9m)		C4
			S0010E-S	635320102	Infant Silicone Soft, 3ft (0.9m)	Sensor Connector:	C4
			S0010F-S	635430102	Neonate Silicone Wrap, 3ft(0.9m)	C4	
			S0010I-S	631190106	Multi-site Y, 4ft(1.2m)	C4	
			S0010G-S	635140102	Adult Ear Clip, 3ft(0.9m)		C4
			S0010B-S	635170102	Adult Finger Clip, 3ft(0.9m)	Need S0010NE-L Instrument Connector:	B5
			S0010C-S	635210102	Pediatric Finger Clip, 3ft(0.9m)		C4
			S0010D-S	635120102	Adult Silicone Soft, 3ft(0.9m)		C4
			S0010P-S	635220102	Pediatric Silicone Soft, 3ft(0.9m)		C4
			S0010E-S	635320102	Infant Silicone Soft, 3ft (0.9m)	Sensor Connector:	C4
			S0010F-S	635430102	Neonate Silicone Wrap, 3ft(0.9m)	C4	
			S0010I-S	635190106	Multi-site Y, 4ft(1.2m)		C4
	S0010G-S	635140102	Adult Ear Clip, 3ft(0.9m)	C4			
NPB3000-3100, Symphony, NPB-290, NPB-295, NPB-395 (OxiSmart Tech.)			S0001B-L	635170014	Adult Finger Clip, 10ft(3m)	/	D0
			S0001C-L	635210014	Pediatric Finger Clip, 10ft(3m)		D0
			S0001D-L	635120014	Adult Silicone Soft, 10ft(3m)		D0
			S0001P-L	635220014	Pediatric Silicone Soft, 10ft(3m)		D0
			S0001F-L	635430014	Neonate Silicone Wrap, 10ft(3m)		D0
			S0001I-L	635190014	Multi-site Y, 10ft(3m)		D0
			S0001G-L	635140014	Adult Ear Clip, 10ft(3m)		D0

OEM Manufacturer & Models	Instrument Connector	OEM#	Old Order Code	New Order Code	Descriptions	Adapter Cable	Price
<b>Compatible Nellcor</b>							
N550, N560, N595, N600, N751, N5500 (Oximax tech)		DS-100A	S0026B-S	635170262	Adult Finger Clip,3ft(0.9m)	Need S0117OX-L Instrument Connector:	C2
			S0026C-S	635210262	Pediatric Finger Clip,3ft(0.9m)		C2
			S0026D-S	635120262	Adult Silicone Soft,3ft(0.9m)		D5
			S0026P-S	635220262	Pediatric Silicone Soft,3ft(0.9m)		D5
			S0026E-S	635320262	Infant Silicone Soft, 3ft (0.9m)	Sensor Connector:	D5
			S0026F-S	635430262	Neonate Silicone Wrap, 3ft(0.9m)	D5	
			S0026I-S	635190266	Multi-site Y, 4ft(1.2m)		D5
			S0026G-S	635140262	Adult Ear Clip, 3ft(0.9m)	D5	
			D-YS		635180262	Adult Silicone ring type, 3ft (0.9m)	D5
<b>Compatible Nihon Kohden</b>							
Lifescop S, BSS-9800 Lifescop M, BSM 9510 Lifescop PBSM 4100 Life scop A, BSM 5100 Lifescop L, BSM 2350 Lifescop I, BSM 2301K, 2303K		TL-101T, TL-201T	S0005B-L	635170054	Adult Finger Clip,10ft(3m)	/	D5
			S0005C-L	635210054	Pediatric Finger Clip,10ft(3m)		D0
			S0005D-L	635120054	Adult Silicone Soft,10ft(3m)		D0
			S0005P-L	635220054	Pediatric Silicone Soft,10ft(3m)		D0
			S0005E-L	635320054	Infant Silicone Soft, 10ft (3m)		D0
			S0005F-L	635430054	Neonate Silicone Wrap, 10ft(3m)		D0
			S0005I-L	635190054	Multi-site Y, 10ft(3m)		D0
			S0005G-L	635140054	Adult Ear Clip, 10ft(3m)		D0
		Lifescop S, BSS-9800 Lifescop M, BSM 9510 Lifescop P, BSM 4100 Life scop A, BSM 5100 Lifescop L, BSM 2350 Lifescop IBSM 2301K, 2303K			S0005B-S		635170052
	S0005C-S			635210052	Pediatric Finger Clip,3ft(0.9m)	D5	
	S0005D-S			635120052	Adult Silicone Soft,3ft(0.9m)		D5
	S0005P-S			635220052	Pediatric Silicone Soft,3ft(0.9m)	Sensor Connector:	D5
	S0005E-S			635320052	Infant Silicone Soft, 3ft (0.9m)	D5	
	S0005F-S			635430052	Neonate Silicone Wrap, 3ft(0.9m)		D5
	S0005I-S			635190056	Multi-site Y, 4ft(1.2m)	D5	
	S0005G-S			635140052	Adult Ear Clip, 3ft(0.9m)	D5	
OPV-1500, OPV-3100					S0005B-S	635170052	Adult Finger Clip,3ft(0.9m)
			S0005C-S	635210052	Pediatric Finger Clip,3ft(0.9m)	D5	
			S0005D-S	635120052	Adult Silicone Soft,3ft(0.9m)		D5
			S0005P-S	635220052	Pediatric Silicone Soft,3ft(0.9m)	Sensor Connector:	D5
			S0005E-S	635320052	Infant Silicone Soft, 3ft (0.9m)	D5	
			S0005F-S	635430052	Neonate Silicone Wrap, 3ft(0.9m)		D5
			S0005I-S	635190056	Multi-site Y, 4ft(1.2m)	D5	
			S0005G-S	635140052	Adult Ear Clip, 3ft(0.9m)	D5	

OEM Manufacturer & Models	Instrument Connector	OEM#	Old Order Code	New Order Code	Descriptions	Adapter Cable	Price
<b>Compatible Nihon Kohden</b>							
BSM-1101/ 2101/23101 7100, 7200, OLV-1100 ALife scope			S0069B-L	635170694	Adult Finger Clip, 10ft(3m)	/	D5
			S0069C-L	635210694	Pediatric Finger Clip, 10ft(3m)		D5
			S0069D-L	635120694	Adult Silicone Soft, 10ft(3m)		E5
			S0069P-L	635220694	Pediatric Silicone Soft, 10ft(3m)		E5
			S0069F-L	635430694	Neonate Silicone Wrap, 10ft(3m)		E5
			S0069I-L	635190694	Multi-site Y, 10ft(3m)		E5
			S0069G-L	635140694	Adult Ear Clip, 10ft(3m)		E5
Nihon Kohden Svm-7500/ 7600		JL-701P		635175614	Adult Finger Clip, 10ft(3m)	/	D5
				635215614	Pediatric Finger Clip, 10ft(3m)		D5
				635125614	Adult Silicone Soft, 10ft(3m)		E5
				635225614	Pediatric Silicone Soft, 10ft(3m)		E5
				635435614	Neonate Silicone Wrap, 10ft(3m)		E5
				635195614	Multi-site Y, 10ft(3m)		E5
				635145614	Adult Ear Clip, 10ft(3m)		E5
<b>Compatible Neusoft (China)</b>							
NSC series (Oxi tech)		DS100A	S0026B-S	635170262	Adult Finger Clip, 3ft(0.9m)	Need S0003OX-L Instrument Connector:  Sensor Connector: 	C2
			S0026C-S	635210262	Pediatric Finger Clip, 3ft(0.9m)		C2
			S0026D-S	635120262	Adult Silicone Soft, 3ft(0.9m)		D5
			S0026P-S	635220262	Pediatric Silicone Soft, 3ft(0.9m)		D5
			S0026F-S	635430262	Neonate Silicone Wrap, 3ft(0.9m)		D5
		D-YS	S0026I-S	635190266	Multi-site Y, 4ft(1.2m)		D5
			S0026G-S	635140262	Adult Ear Clip, 3ft(0.9m)		D5
			S0003B-L	635170034	Adult Finger Clip, 10ft(3m)	/	C0
			S0003C-L	635210034	Pediatric Finger Clip, 10ft(3m)		D2
			S0003D-L	635120034	Adult Silicone Soft, 10ft(3m)		D2
			S0003P-L	635220034	Pediatric Silicone Soft, 10ft(3m)		D2
			S0003F-L	635430034	Neonate Silicone Wrap, 10ft(3m)		D2
			S0003I-L	635190034	Multi-site Y, 10ft(3m)		D2
			S0003G-L	635140034	Adult Ear Clip, 10ft(3m)		D2
<b>Compatible Novamatrix</b>							
505, 510, 511, 515B/C, 520, 7000, 7100, Oxypleth		369083-001, 8776-00	S0062B-L	635170624	Adult Finger Clip, 10ft(3m)	/	C0
			S0062C-L	635210624	Pediatric Finger Clip, 10ft(3m)		D2
			S0062D-L	635120624	Adult Silicone Soft, 10ft(3m)		D2
			S0062P-L	635220624	Pediatric Silicone Soft, 10ft(3m)		D2
			S0062F-L	635430624	Neonate Silicone Wrap, 10ft(3m)		D2
			S0062I-L	635190624	Multi-site Y, 10ft(3m)		D2
			S0062G-L	635140624	Adult Ear Clip, 10ft(3m)		D2

OEM Manufacturer & Models	Instrument Connector	OEM#	Old Order Code	New Order Code	Descriptions	Adapter Cable	Price
<b>Compatible Novametrix</b>							
512/513/710/ 715, MARS		8776-00 9768-00	S0062B-S	635170622	Adult Finger Clip,3ft(0.9m)	/	C0
			S0062C-S	635210622	Pediatric Finger Clip,3ft(0.9m)		D2
			S0062D-S	635120622	Adult Silicone Soft,3ft(0.9m)		D2
			S0062P-S	635220622	Pediatric Silicone Soft,3ft(0.9m)		D2
			S0062F-S	635430622	Neonate Silicone Wrap, 3ft(0.9m)		D2
			S0062I-S	635190626	Multi-site Y, 4ft(1.2m)		D2
			S0062G-S	635140622	Adult Ear Clip, 3ft(0.9m)		D2
505, 510, 511, 515B/C, 520, 7000, 7100, Oxypleth		8776-00 9768-00	S0062B-S	635170622	Adult Finger Clip,3ft(0.9m)	Need S0062NE-L Instrument Connector:	C0
			S0062C-S	635210622	Pediatric Finger Clip,3ft(0.9m)		D2
			S0062D-S	635120622	Adult Silicone Soft,3ft(0.9m)	Sensor Connector:	D2
			S0062P-S	635220622	Pediatric Silicone Soft,3ft(0.9m)		D2
			S0062F-S	635430622	Neonate Silicone Wrap, 3ft(0.9m)		D2
			S0062I-S	635190626	Multi-site Y, 4ft(1.2m)		D2
			S0062G-S	635140622	Adult Ear Clip, 3ft(0.9m)		D2
<b>Compatible NCC Medical (China)</b>							
NTS3000 (OxiSmart) (Non-oximax)			S0010B-S	635170102	Adult Finger Clip,3ft(0.9m)	Need S0192NE-L Instrument Connector:	B5
			S0010C-S	635210102	Pediatric Finger Clip,3ft(0.9m)		C4
			S0010D-S	635120102	Adult Silicone Soft,3ft(0.9m)	Sensor Connector:	C4
			S0010P-S	635220102	Pediatric Silicone Soft,3ft(0.9m)		C4
			S0010F-S	635430102	Neonate Silicone Wrap, 3ft(0.9m)		C4
			S0010I-S	635190106	Multi-site Y, 4ft(1.2m)		C4
			S0010G-S	635140102	Adult Ear Clip, 3ft(0.9m)		C4
<b>Compatible Nonin</b>							
8500, 8600, 8700, 8800 NONIN: 2500		8000AA	S0080B-L	635170804	Adult Finger Clip,10ft(3m)	/	C0
		8000AP	S0080C-L	635210804	Pediatric Finger Clip,10ft(3m)		D2
		8000AA	S0080D-L	635120804	Adult Silicone Soft,10ft(3m)		D2
			S0080P-L	635220804	Pediatric Silicone Soft,10ft(3m)		D2
		8000AP	S0080E-L	635320804	Infant Silicone Soft, 10ft (3m)		D2
			S0080F-L	635430804	Neonate Silicone Wrap, 10ft(3m)		D2
			S0080I-L	635190804	Multi-site Y, 10ft(3m)		D2
			S0080G-L	635140804	Adult Ear Clip, 10ft(3m)		D2













OEM Manufacturer & Models	Instrument Connector	OEM#	Old Order Code	New Order Code	Descriptions	Adapter Cable	Price
<b>Compatible Nonin</b>							
8500, 2500, 9840, Avant: 4000, 9600, 9700 Avant: 2120 PulseSense Model: 7500, 7500FO (Nonin Tech)		8000AA, 8000AA-2, 8000AA-3, 01-02 0250, 01-03-01170	S0080B-S	635170802	Adult Finger Clip, 3ft(0.9m)	/	C6
		8000AP, 01-03-0121, 01-02-0106	S0080C-S	635210802	Pediatric Finger Clip, 3ft(0.9m)		C6
		8000SL	S0080D-S	635120802	Adult Silicone Soft, 3ft(0.9m)		D2
		8000SM	S0080P-S	635220802	Pediatric Silicone Soft, 3ft(0.9m)		D2
		8000SS	S0080E-S	635320802	Infant Silicone Soft, 3ft (0.9m)		D2
			S0080F-S	635430802	Neonate Silicone Wrap, 3ft(0.9m)		D2
			S0080I-S	635190806	Multi-site Y, 4ft(1.2m)		D2
			S0080G-S	635140802	Adult Ear Clip, 3ft(0.9m)		D2
<b>Compatible Northern Meditec</b>							
Northern Meditec				635175284	Adult Finger Clip, 10ft(3m)	/	C0
				635215284	Pediatric Finger Clip, 10ft(3m)		D2
				635125284	Adult Silicone Soft, 10ft(3m)		D2
				635225284	Pediatric Silicone Soft, 10ft(3m)		D2
				635435284	Neonate Silicone Wrap, 10ft(3m)		D2
				635195284	Multi-site Y, 10ft(3m)		D2
				635145284	Adult Ear Clip, 10ft(3m)	D2	
				635175282	Adult Finger Clip, 3ft(0.9m)	/	C0
				635215282	Pediatric Finger Clip, 3ft(0.9m)		D2
				635125282	Adult Silicone Soft, 3ft(0.9m)		D2
				635225282	Pediatric Silicone Soft, 3ft(0.9m)		D2
				635435282	Neonate Silicone Wrap, 3ft(0.9m)		D2
				635195286	Multi-site Y, 4ft(1.2m)		D2
				635145282	Adult Ear Clip, 3ft(0.9m)		D2
<b>Compatible PETAS (Turkey)</b>							
Horizon 1100, 2000XL Mercury, MR1300 (OxiSmart) (Non-oximax)			S0010B-S	635170102	Adult Finger Clip, 3ft(0.9m)	Need S0089BC-L Instrument Connector:  Sensor Connector: 	B5
			S0010C-S	635210102	Pediatric Finger Clip, 3ft(0.9m)		C4
			S0010D-S	635120102	Adult Silicone Soft, 3ft(0.9m)		C4
			S0010P-S	635220102	Pediatric Silicone Soft, 3ft(0.9m)		C4
			S0010F-S	635430102	Neonate Silicone Wrap, 3ft(0.9m)		C4
			S0010I-S	635190106	Multi-site Y, 4ft(1.2m)		C4
			S0010G-S	635140102	Adult Ear Clip, 3ft(0.9m)		C4

OEM Manufacturer & Models	Instrument Connector	OEM#	Old Order Code	New Order Code	Descriptions	Adapter Cable	Price	
<b>Compatible Philips</b>								
78352C, 78354C, 78834C, M1020A, M1025B, M1025A, M1350B, M1772A/B, M1732A/B, M2475B M3, M4, MP20, MP30, MP40, MP50, MP70, MP80, VM4, VM6, VM8			S0003B-L	635170034	Adult Finger Clip, 10ft(3m)	/	C0	
			S0003C-L	635210034	Pediatric Finger Clip, 10ft(3m)		D2	
			S0003D-L	635120034	Adult Silicone Soft, 10ft(3m)		D2	
			S0003P-L	635220034	Pediatric Silicone Soft, 10ft(3m)		D2	
			S0003F-L	635430034	Neonate Silicone Wrap, 10ft(3m)		D2	
			S0003I-L	635190034	Multi-site Y, 10ft(3m)		D2	
			S0003G-L	635140034	Adult Ear Clip, 10ft(3m)		D2	
			S0010B-S	635170102	Adult Finger Clip, 3ft(0.9m)	Need S0003OX-L Instrument Connector:	B5	
			S0010C-S	635210102	Pediatric Finger Clip, 3ft(0.9m)		C4	
			S0010D-S	635120102	Adult Silicone Soft, 3ft(0.9m)	C4		
			S0010P-S	635220102	Pediatric Silicone Soft, 3ft(0.9m)	Sensor Connector:	C4	
			S0010F-S	635430102	Neonate Silicone Wrap, 3ft(0.9m)	C4		
			S0010I-S	635190106	Multi-site Y, 4ft(1.2m)	C4		
			S0010G-S	635140102	Adult Ear Clip, 3ft(0.9m)		C4	
			S0015B-S	635170152	Adult Finger Clip, 3ft(0.9m)	Need S0003PH-L Instrument Connector:	C0	
			S0015C-S	635210152	Pediatric Finger Clip, 3ft(0.9m)	D2		
			S0015D-S	635120152	Adult Silicone Soft, 3ft(0.9m)	D2		
			S0015P-S	635220152	Pediatric Silicone Soft, 3ft(0.9m)		D2	
			S0015E-S	635320152	Infant Silicone Soft, 3ft (0.9m)	Sensor Connector:	D2	
			S0015F-S	635430152	Neonate Silicone Wrap, 3ft(0.9m)	D2		
			S0015I-S	635190156	Multi-site Y, 4ft(1.2m)	D2		
			S0015G-S	635140152	Adult Ear Clip, 3ft(0.9m)		D2	
	C1, C3, M3, M4, VirDia, MP20, MP30, MP40/50/60/ 70/90. VM4, VM6, VM8			S0010B-S	635170102	Adult Finger Clip, 3ft(0.9m)	Need S0015OX-L Instrument Connector:	B5
				S0010C-S	635210102	Pediatric Finger Clip, 3ft(0.9m)	C4	
				S0010D-S	635120102	Adult Silicone Soft, 3ft(0.9m)		C4
				S0010P-S	635220102	Pediatric Silicone Soft, 3ft(0.9m)	Sensor Connector:	C4
				S0010F-S	635430102	Neonate Silicone Wrap, 3ft(0.9m)	C4	
				S0010I-S	635190106	Multi-site Y, 4ft(1.2m)	C4	
			S0010G-S	635140102	Adult Ear Clip, 3ft(0.9m)		C4	
			S0015B-S	635170152	Adult Finger Clip, 3ft(0.9m)	Need S0015PH-L Instrument Connector:	C0	
			S0015C-S	635210152	Pediatric Finger Clip, 3ft(0.9m)	D2		
			S0015D-S	635120152	Adult Silicone Soft, 3ft(0.9m)	D2		
			S0015P-S	635220152	Pediatric Silicone Soft, 3ft(0.9m)		D2	
			S0015E-S	635320152	Infant Silicone Soft, 3ft (0.9m)	Sensor Connector:	D2	
			S0015F-S	635430152	Neonate Silicone Wrap, 3ft(0.9m)	D2		
			S0015I-S	635190156	Multi-site Y, 4ft(1.2m)	D2		
			S0015G-S	635140152	Adult Ear Clip, 3ft(0.9m)		D2	











OEM Manufacturer & Models	Instrument Connector	OEM#	Old Order Code	New Order Code	Descriptions	Adapter Cable	Price
<b>Compatible Philips</b>							
78352C, 78354C, 78834C, M1020A, M1025B, M1025A, M1350B, M1772A/B, M1732A/B, M2475B M3, M4, MP20, MP30, MP40, MP50, MP70, MP80, VM4, VM6, VM8			S0015B-S	635170152	Adult Finger Clip,3ft(0.9m)	Need S0015PH-L Instrument Connector:	C0
			S0015C-S	635210152	Pediatric Finger Clip,3ft(0.9m)		D2
			S0015D-S	635120152	Adult Silicone Soft,3ft(0.9m)		D2
			S0015P-S	635220152	Pediatric Silicone Soft,3ft(0.9m)		D2
			S0015E-S	635320152	Infant Silicone Soft, 3ft (0.9m)	Sensor Connector:	D2
			S0015F-S	635430152	Neonate Silicone Wrap, 3ft(0.9m)		D2
			S0015I-S	635190156	Multi-site Y, 4ft(1.2m)		D2
			S0015G-S	635140152	Adult Ear Clip, 3ft(0.9m)		D2
			S0015B-L	635170154	Adult Finger Clip,10ft(3m)	/	C0
			S0015C-L	635210154	Pediatric Finger Clip,10ft(3m)		D2
			S0015D-L	635120154	Adult Silicone Soft,10ft(3m)		D2
			S0015P-L	635220154	Pediatric Silicone Soft,10ft(3m)		D2
			S0015E-L	635320154	Infant Silicone Soft, 10ft (3m)		D2
			S0015F-L	635430154	Neonate Silicone Wrap, 10ft(3m)		D2
			S0015I-L	635190154	Multi-site Y, 10ft(3m)		D2
			S0015G-L	635140154	Adult Ear Clip, 10ft(3m)		D2
		A1, A3			S0010B-S		635170102
	S0010C-S			635210102	Pediatric Finger Clip,3ft(0.9m)		C4
	S0010D-S			635120102	Adult Silicone Soft,3ft(0.9m)		C4
	S0010P-S			635220102	Pediatric Silicone Soft,3ft(0.9m)	Sensor Connector:	C4
	S0010F-S			635430102	Neonate Silicone Wrap, 3ft(0.9m)		C4
	S0010I-S			635190106	Multi-site Y, 4ft(1.2m)		C4
	S0010G-S			635140102	Adult Ear Clip, 3ft(0.9m)		C4
N550, N560, N595, N600, N751, N5500 MP20/30/40/50 PM60/70/90 VN4, VM6, VM8(Oxi tech)		DS100A	S0026B-S	635170262	Adult Finger Clip,3ft(0.9m)	Need S0414OX-L Instrument Connector:	C2
			S0026C-S	635210262	Pediatric Finger Clip,3ft(0.9m)		C2
			S0026D-S	635120262	Adult Silicone Soft,3ft(0.9m)		D5
			S0026P-S	635220262	Pediatric Silicone Soft,3ft(0.9m)	Sensor Connector:	D5
			S0026F-S	635430262	Neonate Silicone Wrap, 3ft(0.9m)		D5
		D-YS	S0026I-S	635190266	Multi-site Y, 4ft(1.2m)		D5
			S0026G-S	635140262	Adult Ear Clip, 3ft(0.9m)		D5

OEM Manufacturer & Models	Instrument Connector	OEM#	Old Order Code	New Order Code	Descriptions	Adapter Cable	Price
<b>Compatible Philips</b>							
MP20/30/40/ PM50/60/70/ 90 VN4, VM6, VM8 (Masimo tech)			S0442B-S	635174422	Adult Finger Clip,3ft(0.9m)	Need S0197CS-L Instrument Connector:  Sensor Connector: 	C0
			S0442C-S	635214422	Pediatric Finger Clip,3ft(0.9m)		C0
			S0442D-S	635124422	Adult Silicone Soft,3ft(0.9m)		C0
			S0442P-S	635224422	Pediatric Silicone Soft,3ft(0.9m)		C0
			S0442E-S	635324422	Infant Silicone Soft, 3ft (0.9m)		C0
			S0442F-S	635434422	Neonate Silicone Wrap, 3ft(0.9m)		C0
			S0442I-S	635194426	Multi-site Y, 4ft(1.2m)		C0
			S0442G-S	635144422	Adult Ear Clip, 3ft(0.9m)		C0
			S0197B-L	635171974	Adult Finger Clip,10ft(3m)		E5
			S0197C-L	635211974	Pediatric Finger Clip,10ft(3m)		E5
			S0197D-L	635121974	Adult Silicone Soft,10ft(3m)		E5
			S0197P-L	635221974	Pediatric Silicone Soft,10ft(3m)		E5
			S0197F-L	635431974	Neonate Silicone Wrap, 10ft(3m)		E5
			S0197I-L	635191974	Multi-site Y, 10ft(3m)		E5
		S0197G-L	635141974	Adult Ear Clip, 10ft(3m)	E5		
<b>Compatible Primedic</b>							
(OxiSmart) (Non-oximax)			S0010B-S	635170102	Adult Finger Clip,3ft(0.9m)	Need S0140NE-L Instrument Connector:  Sensor Connector: 	B5
			S0010C-S	635210102	Pediatric Finger Clip,3ft(0.9m)		C4
			S0010D-S	635120102	Adult Silicone Soft,3ft(0.9m)		C4
			S0010P-S	635220102	Pediatric Silicone Soft,3ft(0.9m)		C4
			S0010F-S	635430102	Neonate Silicone Wrap, 3ft(0.9m)		C4
			S0010I-S	635190106	Multi-site Y, 4ft(1.2m)		C4
			S0010G-S	635140102	Adult Ear Clip, 3ft(0.9m)		C4
<b>Compatible RGB medical</b>							
Omicrom FT, Omicron PREMIUM (BCI tech module)		3044	S0076B-S	635170762	Adult Finger Clip,3ft(0.9m)	Need S0111BC-L Instrument Connector:  Sensor Connector: 	C2
		3178	S0076C-S	635210762	Pediatric Finger Clip,3ft(0.9m)		C4
		3044	S0076D-S	635120762	Adult Silicone Soft,3ft(0.9m)		C4
			S0076P-S	635220762	Pediatric Silicone Soft,3ft(0.9m)		C4
		3178	S0076E-S	635320762	Infant Silicone Soft, 3ft (0.9m)		C4
			S0076F-S	635430762	Neonate Silicone Wrap, 3ft(0.9m)		C4
			S0076I-S	635190766	Multi-site Y, 4ft(1.2m)		C4
			S0076G-S	635140762	Adult Ear Clip, 3ft(0.9m)		C4

OEM Manufacturer & Models	Instrument Connector	OEM#	Old Order Code	New Order Code	Descriptions	Adapter Cable	Price
<b>Compatible 3F/LANKE/CSI(RADO)/MAYTAG/Shichuang</b>							
LANKE: LK-8600A/ CSI: RADO4200/ MAYTAG: MTK-2000/Shichuang: Prophet21			S0021B-L	635170214	Adult Finger Clip, 10ft(3m)	/	C0
			S0021C-L	635210214	Pediatric Finger Clip, 10ft(3m)		D2
			S0021D-L	635120214	Adult Silicone Soft, 10ft(3m)		D2
			S0021P-L	635220214	Pediatric Silicone Soft, 10ft(3m)		D2
			S0021F-L	635430214	Neonate Silicone Wrap, 10ft(3m)		D2
			S0021I-L	635190214	Multi-site Y, 10ft(3m)		D2
			S0021G-L	635140214	Adult Ear Clip, 10ft(3m)		D2
<b>Compatible Siemens</b>							
Sirecust 630, Sirecust 700, Sirem SpO2 Module			S0078B-L	635170784	Adult Finger Clip, 10ft(3m)	/	C0
			S0078C-L	635210784	Pediatric Finger Clip, 10ft(3m)		D2
			S0078D-L	635120784	Adult Silicone Soft, 10ft(3m)		D2
			S0078P-L	635220784	Pediatric Silicone Soft, 10ft(3m)		D2
			S0078F-L	635430784	Neonate Silicone Wrap, 10ft(3m)		D2
			S0078I-L	635190784	Multi-site Y, 10ft(3m)		D2
			S0078G-L	635140784	Adult Ear Clip, 10ft(3m)		D2
<b>Compatible SAZGAN</b>							
			S0161B-L	635171614	Adult Finger Clip, 10ft(3m)	/	C0
			S0161C-L	635211614	Pediatric Finger Clip, 10ft(3m)		D2
			S0161D-L	635121614	Adult Silicone Soft, 10ft(3m)		D2
			S0161P-L	635221614	Pediatric Silicone Soft, 10ft(3m)		D2
			S0161F-L	635431614	Neonate Silicone Wrap, 10ft(3m)		D2
			S0161I-L	635191614	Multi-site Y, 10ft(3m)		D2
			S0161G-L	635141614	Adult Ear Clip, 10ft(3m)		D2
<b>Compatible Schiller/Bruker (Odam)</b>							
Argus LCM, Argus Pro, TM7 (Masimo tech)			S0442B-S	635174422	Adult Finger Clip, 3ft(0.9m)	Need S0118CS-L Instrument Connector:  Sensor Connector: 	C0
			S0442C-S	635214422	Pediatric Finger Clip, 3ft(0.9m)		C0
			S0442D-S	635124422	Adult Silicone Soft, 3ft(0.9m)		C0
			S0442P-S	635224422	Pediatric Silicone Soft, 3ft(0.9m)		C0
			S0442E-S	635324422	Infant Silicone Soft, 3ft(0.9m)		C0
			S0442F-S	635434422	Neonate Silicone Wrap, 3ft(0.9m)		C0
			S0442I-S	635194426	Multi-site Y, 4ft(1.2m)		C0
			S0442G-S	635144422	Adult Ear Clip, 3ft(0.9m)		C0

OEM Manufacturer & Models	Instrument Connector	OEM#	Old Order Code	New Order Code	Descriptions	Adapter Cable	Price
<b>Compatible Schiller/Bruker (Odam)</b>							
Argus LCM, Argus Pro, TM7 (Masimo tech)			S0118B-L	635171184	Adult Finger Clip, 10ft(3m)	/	C0
			S0118C-L	635211184	Pediatric Finger Clip, 10ft(3m)		D2
			S0118D-L	635121184	Adult Silicone Soft, 10ft(3m)		D2
			S0118P-L	635221184	Pediatric Silicone Soft, 10ft(3m)		D2
			S0118F-L	635431184	Neonate Silicone Wrap, 10ft(3m)		D2
			S0118I-L	635191184	Multi-site Y, 10ft(3m)		D2
			S0118G-L	635141184	Adult Ear Clip, 10ft(3m)		D2
Propaq CS, Encore, Micropaq (New) (M) (Masimo tech)		2053	S0442B-L	635174424	Adult Finger Clip, 10ft(3m)	/	D0
			S0442C-L	635214424	Pediatric Finger Clip, 10ft(3m)		D0
			S0442D-L	635124424	Adult Silicone Soft, 10ft(3m)		D0
			S0442P-L	635224424	Pediatric Silicone Soft, 10ft(3m)		D0
			S0442E-L	635324424	Infant Silicone Soft, 10ft (3m)		D0
			S0442F-L	635434424	Neonate Silicone Wrap, 10ft(3m)		D0
			S0442I-L	635194424	Multi-site Y, 10ft(3m)		D0
			S0442G-L	635144424	Adult Ear Clip, 10ft(3m)		D0
			635184422	Adult Silicone ring type, 3ft (0.9m)	D0		
			S0442B-S	635174422	Adult Finger Clip, 3ft(0.9m)	Need S0442CS-L Instrument Connector:	C0
			S0442C-S	635214422	Pediatric Finger Clip, 3ft(0.9m)		C0
			S0442D-S	635124422	Adult Silicone Soft, 3ft(0.9m)	Sensor Connector:	C0
			S0442P-S	635224422	Pediatric Silicone Soft, 3ft(0.9m)		C0
			S0442E-S	635324422	Infant Silicone Soft, 3ft (0.9m)	Sensor Connector:	C0
			S0442F-S	635434422	Neonate Silicone Wrap, 3ft(0.9m)		C0
		S0442I-S	635194426	Multi-site Y, 4ft(1.2m)		C0	
	S0442G-S	635144422	Adult Ear Clip, 3ft(0.9m)		C0		
Argus VCM (Nellcor Oximax)		DS100A	S0026B-S	635170262	Adult Finger Clip, 3ft(0.9m)	Need S0117OX-L Instrument Connector:	C2
			S0026C-S	635210262	Pediatric Finger Clip, 3ft(0.9m)		C2
			S0026D-S	635120262	Adult Silicone Soft, 3ft(0.9m)	Sensor Connector:	D5
			S0026P-S	635220262	Pediatric Silicone Soft, 3ft(0.9m)		D5
			S0026F-S	635430262	Neonate Silicone Wrap, 3ft(0.9m)	Sensor Connector:	D5
		D-YS	S0026I-S	635190266	Multi-site Y, 4ft(1.2m)		D5
			S0026G-S	635140262	Adult Ear Clip, 3ft(0.9m)		D5





OEM Manufacturer & Models	Instrument Connector	OEM#	Old Order Code	New Order Code	Descriptions	Adapter Cable	Price
<b>Compatible Schiller/Bruker (Odam)</b>							
Propaq CS, Encore Series, Atlas (Nellcor OxiSmart)			S0010B-S	635170102	Adult Finger Clip,3ft(0.9m)	Need S0010NE-L Instrument Connector:	B5
			S0010C-S	635210102	Pediatric Finger Clip,3ft(0.9m)		C4
			S0010D-S	635120102	Adult Silicone Soft,3ft(0.9m)		C4
			S0010P-S	635220102	Pediatric Silicone Soft,3ft(0.9m)		C4
			S0010F-S	635430102	Neonate Silicone Wrap, 3ft(0.9m)	Sensor Connector:	C4
			S0010I-S	635190106	Multi-site Y, 4ft(1.2m)		C4
			S0010G-S	635140102	Adult Ear Clip, 3ft(0.9m)		C4
TM 910-Defigard 500(M) (Nellcor OxiSmart)			S0010B-S	635170102	Adult Finger Clip,3ft(0.9m)	Need S0071BC-L Instrument Connector:	B5
			S0010C-S	635210102	Pediatric Finger Clip,3ft(0.9m)		C4
			S0010D-S	635120102	Adult Silicone Soft,3ft(0.9m)		C4
			S0010P-S	635220102	Pediatric Silicone Soft,3ft(0.9m)		C4
			S0010F-S	635430102	Neonate Silicone Wrap, 3ft(0.9m)	Sensor Connector:	C4
			S0010I-S	635190106	Multi-site Y, 4ft(1.2m)		C4
			S0010G-S	635140102	Adult Ear Clip, 3ft(0.9m)		C4
<b>Compatible Spacelabs</b>							
90419/01, 90651A/07, 90501, Ultraview 90496 (Novamatrix tech)		369083001, 8776-00	S0062B-L	635170624	Adult Finger Clip,10ft(3m)	/	C0
			S0062C-L	635210624	Pediatric Finger Clip,10ft(3m)		D2
			S0062D-L	635120624	Adult Silicone Soft,10ft(3m)		D2
			S0062P-L	635220624	Pediatric Silicone Soft,10ft(3m)		D2
			S0062F-L	635430624	Neonate Silicone Wrap, 10ft(3m)		D2
			S0062I-L	635190624	Multi-site Y, 10ft(3m)		D2
			S0062G-L	635140624	Adult Ear Clip, 10ft(3m)		D2
90351-0/6, 90465, 90466, 90456, PC express (Nellcor OxiSmart)			S0010B-S	635170102	Adult Finger Clip,3ft(0.9m)	Need S0035NE-L Instrument Connector:	B5
			S0010C-S	635210102	Pediatric Finger Clip,3ft(0.9m)		C4
			S0010D-S	635120102	Adult Silicone Soft,3ft(0.9m)		C4
			S0010P-S	635220102	Pediatric Silicone Soft,3ft(0.9m)		C4
			S0010F-S	635430102	Neonate Silicone Wrap, 3ft(0.9m)	Sensor Connector:	C4
			S0010I-S	635190106	Multi-site Y, 4ft(1.2m)		C4
			S0010G-S	635140102	Adult Ear Clip, 3ft(0.9m)		C4
			S0035B-L	635170354	Adult Finger Clip,10ft(3m)	/	C0
			S0035C-L	635210354	Pediatric Finger Clip,10ft(3m)		D2
			S0035D-L	635120354	Adult Silicone Soft,10ft(3m)		D2
			S0035P-L	635220354	Pediatric Silicone Soft,10ft(3m)		D2
			S0035F-L	635430354	Neonate Silicone Wrap, 10ft(3m)		D2
			S0035I-L	635190354	Multi-site Y, 10ft(3m)		D2
			S0035G-L	635140354	Adult Ear Clip, 10ft(3m)		D2

OEM Manufacturer & Models	Instrument Connector	OEM#	Old Order Code	New Order Code	Descriptions	Adapter Cable	Price
<b>Compatible Spacelabs</b>							
Ultraview (Masimo tech)			S0442B-S	635174422	Adult Finger Clip,3ft(0.9m)	Need S0004CS-L Instrument Connector:  Sensor Connector: 	C0
			S0442C-S	635214422	Pediatric Finger Clip,3ft(0.9m)		C0
			S0442D-S	635124422	Adult Silicone Soft,3ft(0.9m)		C0
			S0442P-S	635224422	Pediatric Silicone Soft,3ft(0.9m)		C0
			S0442E-S	635324422	Infant Silicone Soft, 3ft (0.9m)		C0
			S0442F-S	635434422	Neonate Silicone Wrap, 3ft(0.9m)		C0
			S0442I-S	635194426	Multi-site Y, 4ft(1.2m)		C0
		S0442G-S	635144422	Adult Ear Clip, 3ft(0.9m)	C0		
			S0412B-L	635174124	Adult Finger Clip,10ft(3m)	/      	E5
			S0412C-L	635214124	Pediatric Finger Clip,10ft(3m)		E0
			S0412D-L	635124124	Adult Silicone Soft,10ft(3m)		E0
			S0412P-L	635224124	Pediatric Silicone Soft,10ft(3m)		E0
			S0412F-L	635434124	Neonate Silicone Wrap, 10ft(3m)		E0
			S0412I-L	635194124	Multi-site Y, 10ft(3m)		E0
		S0412G-L	635144124	Adult Ear Clip, 10ft(3m)	E0		
1050, 1600, 1700, 90369, 90469, 90496 Ultraview (Nellcor OxiSmart)			S0010B-S	635170102	Adult Finger Clip,3ft(0.9m)	Need S0004NE-L Instrument Connector:  Sensor Connector: 	B5
			S0010C-S	635210102	Pediatric Finger Clip,3ft(0.9m)		C4
			S0010D-S	635120102	Adult Silicone Soft,3ft(0.9m)		C4
			S0010P-S	635220102	Pediatric Silicone Soft,3ft(0.9m)		C4
			S0010F-S	635430102	Neonate Silicone Wrap, 3ft(0.9m)		C4
			S0010I-S	635190106	Multi-site Y, 4ft(1.2m)		C4
			S0010G-S	635140102	Adult Ear Clip, 3ft(0.9m)		C4
			S0004B-L	635170044	Adult Finger Clip,10ft(3m)	/      	E5
			S0004C-L	635210044	Pediatric Finger Clip,10ft(3m)		E0
			S0004D-L	635120044	Adult Silicone Soft,10ft(3m)		E0
			S0004P-L	635220044	Pediatric Silicone Soft,10ft(3m)		E0
			S0004F-L	635430044	Neonate Silicone Wrap, 10ft(3m)		E0
			S0004I-L	635190044	Multi-site Y, 10ft(3m)		E0
			S0004G-L	635140044	Adult Ear Clip, 10ft(3m)		E0
PRO2 (BCI tech )		3044	S0076B-S	635170762	Adult Finger Clip,3ft(0.9m)	Need S0076BC-L Instrument Connector:  BCI Sensor Connector: 	C2
		3178	S0076C-S	635210762	Pediatric Finger Clip,3ft(0.9m)		C4
		3044	S0076D-S	635120762	Adult Silicone Soft,3ft(0.9m)		C4
			S0076P-S	635220762	Pediatric Silicone Soft,3ft(0.9m)		C4
		3178	S0076E-S	635320762	Infant Silicone Soft, 3ft (0.9m)		C4
			S0076F-S	635430762	Neonate Silicone Wrap, 3ft(0.9m)		C4
			S0076I-S	635190766	Multi-site Y, 4ft(1.2m)		C4
			S0076G-S	635140762	Adult Ear Clip, 3ft(0.9m)		C4

OEM Manufacturer & Models	Instrument Connector	OEM#	Old Order Code	New Order Code	Descriptions	Adapter Cable	Price
<b>Compatible Spacelabs</b>							
Ultraview (Nellcor Oximax)		DS100A	S0026B-S	635170262	Adult Finger Clip,3ft(0.9m)	Need S0004OX-L Instrument Connector:	C2
			S0026C-S	635210262	Pediatric Finger Clip,3ft(0.9m)		C2
			S0026D-S	635120262	Adult Silicone Soft,3ft(0.9m)		D5
			S0026P-S	635220262	Pediatric Silicone Soft,3ft(0.9m)	Sensor Connector:	D5
			S0026F-S	635430262	Neonate Silicone Wrap, 3ft(0.9m)		D5
		D-YS	S0026I-S	635190266	Multi-site Y, 4ft(1.2m)		D5
			S0026G-S	635140262	Adult Ear Clip, 3ft(0.9m)	D5	
			S0203B-L	635172034	Adult Finger Clip,10ft(3m)	/	E5
			S0203C-L	635212034	Pediatric Finger Clip,10ft(3m)		E0
			S0203D-L	635122034	Adult Silicone Soft,10ft(3m)		E0
			S0203P-L	635222034	Pediatric Silicone Soft,10ft(3m)		E0
			S0203F-L	635432034	Neonate Silicone Wrap, 10ft(3m)		E0
			S0203I-L	635192034	Multi-site Y, 10ft(3m)		E0
			S0203G-L	635142034	Adult Ear Clip, 10ft(3m)		E0
<b>Compatible STRONG (China)</b>							
Prophet21 (BCI tech)			S0021B-L	635170214	Adult Finger Clip,10ft(3m)	/	C0
			S0021C-L	635210214	Pediatric Finger Clip,10ft(3m)		D2
			S0021D-L	635120214	Adult Silicone Soft,10ft(3m)		D2
			S0021P-L	635220214	Pediatric Silicone Soft,10ft(3m)		D2
			S0021F-L	635430214	Neonate Silicone Wrap, 10ft(3m)		D2
			S0021I-L	635190214	Multi-site Y, 10ft(3m)		D2
			S0021G-L	635140214	Adult Ear Clip, 10ft(3m)		D2
<b>Compatible Unicare (China)</b>							
Digital Tech			S0400B-L	635174004	Adult Finger Clip,10ft(3m)	/	C0
			S0400C-L	635214004	Pediatric Finger Clip,10ft(3m)		D2
			S0400D-L	635124004	Adult Silicone Soft,10ft(3m)		D2
			S0400P-I	635224004	Pediatric Silicone Soft,10ft(3m)		D2
			S0400F-L	635434004	Neonate Silicone Wrap, 10ft(3m)		D2
			S0400I-L	635194004	Multi-site Y, 10ft(3m)		D2
			S0400G-L	635144004	Adult Ear Clip, 10ft(3m)		D2

OEM Manufacturer & Models	Instrument Connector	OEM#	Old Order Code	New Order Code	Descriptions	Adapter Cable	Price	
<b>Compatible WEGO (China)</b>								
M3512 (Nellcor OxiSmart)			S0010B-S	635170102	Adult Finger Clip,3ft(0.9m)	Need S0175NE-L Instrument Connector:	B5	
			S0010C-S	635210102	Pediatric Finger Clip,3ft(0.9m)		C4	
			S0010D-S	635120102	Adult Silicone Soft,3ft(0.9m)	 Sensor Connector:	C4	
			S0010P-S	635220102	Pediatric Silicone Soft,3ft(0.9m)		C4	
			S0010F-S	635430102	Neonate Silicone Wrap, 3ft(0.9m)		C4	
			S0010I-S	635190106	Multi-site Y, 4ft(1.2m)	C4		
			S0010G-S	635140102	Adult Ear Clip, 3ft(0.9m)	 C4		
<b>Compatible Zoll</b>								
E Series, M Series, R Series (Masimo Tech)		2053	S0442B-L	635174424	Adult Finger Clip,10ft(3m)	/	D0	
			S0442C-L	635214424	Pediatric Finger Clip,10ft(3m)		D0	
			S0442D-L	635124424	Adult Silicone Soft,10ft(3m)		D0	
			S0442P-L	635224424	Pediatric Silicone Soft,10ft(3m)		D0	
			S0442E-L	635324424	Infant Silicone Soft, 10ft (3m)		D0	
			S0442F-L	635434424	Neonate Silicone Wrap, 10ft(3m)		D0	
			S0442I-L	635194424	Multi-site Y, 10ft(3m)		D0	
			S0442G-L	635144424	Adult Ear Clip, 10ft(3m)		D0	
			635184422		635184422	Adult Silicone ring type, 3ft (0.9m)	D0	
			S0442B-S	635174422	635174422	Adult Finger Clip,3ft(0.9m)	Need S0442CS-L Instrument Connector:	C0
			S0442C-S	635214422	635214422	Pediatric Finger Clip,3ft(0.9m)		C0
			S0442D-S	635124422	635124422	Adult Silicone Soft,3ft(0.9m)	 Sensor Connector:	C0
			S0442P-S	635224422	635224422	Pediatric Silicone Soft,3ft(0.9m)		C0
			S0442E-S	635324422	635324422	Infant Silicone Soft, 3ft (0.9m)		C0
			S0442F-S	635434422	635434422	Neonate Silicone Wrap, 3ft(0.9m)	C0	
	S0442I-S	635194426	635194426	Multi-site Y, 4ft(1.2m)	C0			
	S0442G-S	635144422	635144422	Adult Ear Clip, 3ft(0.9m)	 C0			
<b>Compatible Hexin Zondan (China)</b>								
ZD9000			S0150B-L	635171504	Adult Finger Clip,10ft(3m)	/	C9	
			S0150C-L	635211504	Pediatric Finger Clip,10ft(3m)		D2	
			S0150D-L	635121504	Adult Silicone Soft,10ft(3m)		D2	
			S0150P-L	635221504	Pediatric Silicone Soft,10ft(3m)		D2	
			S0150F-L	635431504	Neonate Silicone Wrap, 10ft(3m)		D2	
			S0150I-L	635191504	Multi-site Y, 10ft(3m)		D2	
			S0150G-L	635141504	Adult Ear Clip, 10ft(3m)		D2	

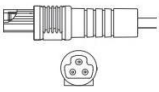
OEM Manufacturer & Models	Instrument Connector	OEM#	Old Order Code	New Order Code	Descriptions	Adapter Cable	Price
<b>Compatible Unicare (China)</b>							
E Series, M Series, R Series (Masimo tech)			S0010B-S	635170102	Adult Finger Clip,3ft(0.9m)	Need S0150NE-L Instrument Connector:  Sensor Connector: 	B5
			S0010C-S	635210102	Pediatric Finger Clip,3ft(0.9m)		C4
			S0010D-S	635120102	Adult Silicone Soft,3ft(0.9m)		C4
			S0010P-S	635220102	Pediatric Silicone Soft,3ft(0.9m)		C4
			S0010F-S	635430102	Neonate Silicone Wrap, 3ft(0.9m)		C4
			S0010I-S	635190106	Multi-site Y, 4ft(1.2m)		C4
			S0010G-S	635140102	Adult Ear Clip, 3ft(0.9m)		C4
			S0150B-L	635171504	Adult Finger Clip,10ft(3m)	/      	C9
			S0150C-L	635211504	Pediatric Finger Clip,10ft(3m)		D2
			S0150D-L	635121504	Adult Silicone Soft,10ft(3m)		D2
			S0150P-L	635221504	Pediatric Silicone Soft,10ft(3m)		D2
			S0150F-L	635431504	Neonate Silicone Wrap, 10ft(3m)		D2
			S0150I-L	635191504	Multi-site Y, 10ft(3m)		D2
			S0150G-L	635141504	Adult Ear Clip, 10ft(3m)		D2
PM-900, F8/S				635170224	Adult Finger Clip,10ft(3m)	/  	C9
				635210224	Pediatric Finger Clip,10ft(3m)		D2
				635430224	Adult Silicone Soft,10ft(3m)		D2
Unicare F8/S				535170224	Adult finger Clip, 6pin, 3M	/  	C9
				535210224	Pediatric finger clip,6pin, 3M		D2
				535430224	Neonatal Wrap, 6pin, 3M		D2
<b>Compatible Medlinket (China)</b>							
TYPE-C			S0197B-L	635175572	Adult Finger Clip,3ft (0.9m)	Need S0557AM-L Instrument Connector:  Sensor Connector: 	
			S0197C-L	635215572	Pediatric Finger Clip,3ft (0.9m)		
			S0197D-L	635125572	Adult Silicone Soft,3ft (0.9m)		
			S0197P-L	635225572	Pediatric Silicone Soft,3ft (0.9m)		
			S0197F-L	635435572	Neonate Silicone Wrap, 3ft (0.9m)		
			S0197I-L	635195572	Multi-site Y, 3ft (0.9m)		
			S0197G-L	635145572	Adult Ear Clip, 3ft (0.9m)		
				635325572	Infant Silicone Soft, 3ft (0.9m)		
6 Multi-com&site SpO2 Sensor & Extension Cable and 5 Y type Multisite Sensor			S0197B-L	635171362	Adult Finger Clip,3ft (0.9m)	/      	
			S0197C-L	635211362	Pediatric Finger Clip,3ft (0.9m)		
			S0197D-L	635121362	Adult Silicone Soft,3ft (0.9m)		
			S0197P-L	635221362	Pediatric Silicone Soft,3ft (0.9m)		
			S0197F-L	635431362	Neonate Silicone Wrap, 3ft (0.9m)		
			S0197I-L	635191362	Multi-site Y,3ft (0.9m)		
			S0197G-L	635141362	Adult Ear Clip, 3ft (0.9m)		
				635321362	Infant Silicone Soft, 3ft (0.9m)		
			635181362	Adult Silicone ring type,3ft (0.9m)			

Photo	OEM#	New Order Code	Descriptions	Price
<b>Compatible Embla Sleep Monitors Oximetry Accessories</b>				
			S0526MD-S-C SpOz Adapter Cable 4pin to 7pin,0.2m	T0
			S0527MD-S-C SpOz Adapter Cable, 3pin to 7pin,0.2m	T0
			933185266 Adult silicone soft SpOz Sensor,1.2m	C0

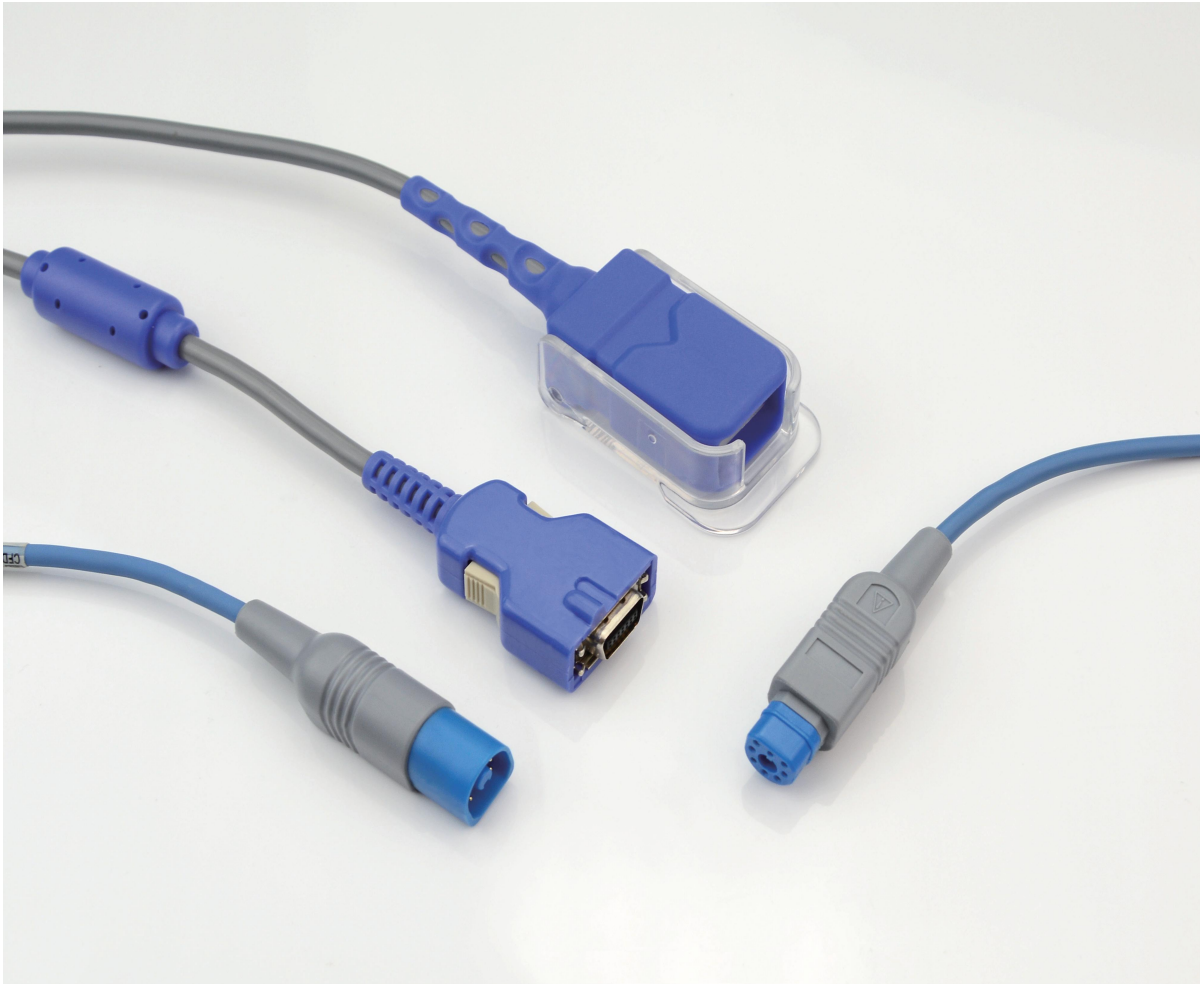

## 5 SpO2 Adapter Cables

### Code Rule Description

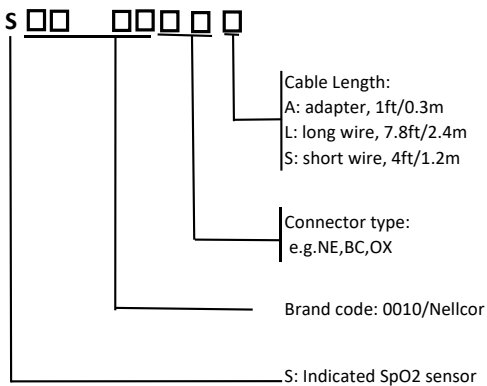

### Product Features

1. Well anti-electromagnetic interference, suitable for complex electrical environment;
2. Easy to change sensor, meeting clinical requirements for patient use;
3. Anti-dust design, TPU cable, injection molding process, more comfortable to use;
4. Fully compatible with OEM technology;
5. Latex free.

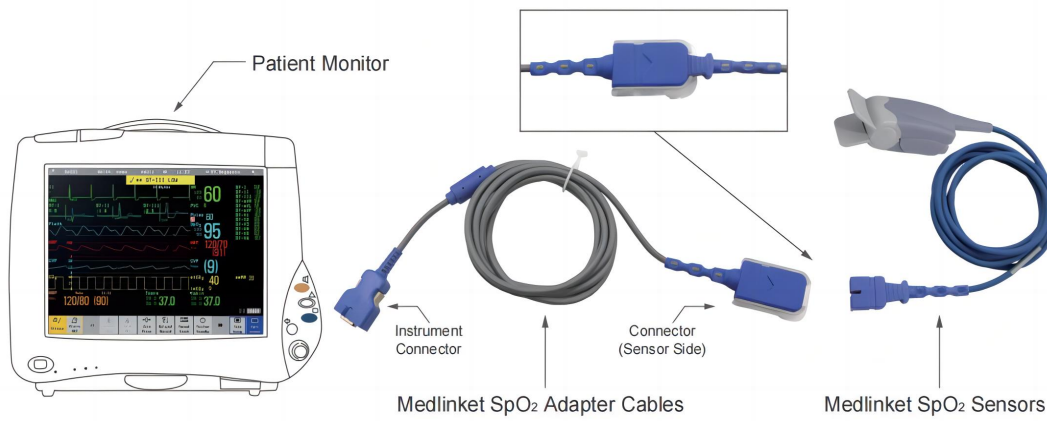

### Connector Type

### Sensor Type

0069	0025	0024
0558	<b>NEW</b>	0116
0239	2909	1871
2049		0841
0064	0068	1615
0073	1569	0115
1643		0734

NE	NI
CO	PH
OX	OH
BC	MA
CS	MD
DO	TS
RD	MS

Fit for Nellcor SpO<sub>2</sub> Sensor

Fit for Nihon Kohden SpO<sub>2</sub> Sensor

Fit for Nellcor SpO<sub>2</sub> Sensor

Fit for Philips SpO<sub>2</sub> Sensor

Fit for Nellcor Oxi-tech SpO<sub>2</sub> Sensor

Fit for GE-OxyTip+ SpO<sub>2</sub> sensor

Fit for BCI SpO<sub>2</sub> Sensor

Fit for Masimo LNCP SpO<sub>2</sub> sensor

Fit for Masimo LNCS SpO<sub>2</sub> sensor

Fit for Medlinket SpO<sub>2</sub> sensor

Fit for Digital SpO<sub>2</sub> sensor



Fit for GE TruSignal SpO<sub>2</sub> sensor

**NEW** Fit for Masimo RD SpO<sub>2</sub> sensor











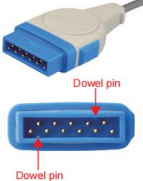

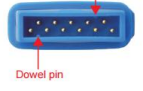

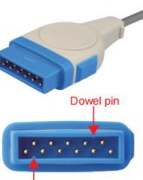
**NEW** Fit for Masimo LNCS SpO<sub>2</sub> sensor

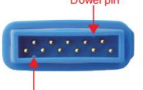

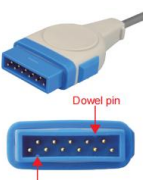

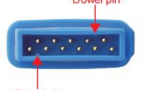







OEM Manufacturer & Models	Instrument Connector	Yoke Connector (Sensor side)	OEM#	Order Code	Descriptions	Compatible Sensor Tech.	Price
<b>Compatible Anke (China)</b>							
AnKe: 553; Biolight; BaoZhong; Cheersails: CSM-2000; WanDong; Goldway: UT4000A UT4000C 4000B; Jumbor: JB9101/9105/9107; TianRong; QILan: M-III; HongRunDa: EM-6; JERRY: PM2000; JoyceTracker: BMD-50; Mindray: PM9000; Richer: RC9000; ShenMai: KP-900; Spurt: CP-1200; SHIPAI: KMI-1000; ZhongHengSheng: KD580; ZhongYua: HD-2000				S0007BC-L	7.8ft (2.4m), fit for BCI probes, and Medlinket S0076 probes	BCI	B4
<b>Compatible AVENTA-M</b>							
AVENTA-M respiratory monitor				S0030NE-L	9PIN>DB9F, 2.43m, fit for Nellcor OxiSmart sensor and Medlinket S0010 probes	BCI	B4
<b>Compatible BCI</b>							
1300, 1301, 1302, 1303, 3100, 3101, 3180, 3300, 3301, 3302, 3303, 3304, 3400, 3401, 3403, 6100, 9100, 9200, Advisor, Autocorr, Capnocheck 9004, Mini Torr, Mini Torr Plus, Spectro 10, Spectro 20, Spectro2 10, Spectro2 20, Spectro2 30, SurgiVet.			3311	S0076BC-L	7.8ft (2.4m), fit for BCI probes, and Medlinket S0076 probes	BCI	B4
1300, 1301, 3180, 3300, 3404, 3444, 4700, 6100, 9100, Advisor, Autocorr, Mini Torr, Mini Torr Plus, Vet/Ox Plus 4600				S0111BC-L	7.8ft (2.4m), fit for BCI probes, and Medlinket S0076 probes	BCI	B4
<b>Compatible Bionet (Korea)</b>							
BM3Vet, BM31				S0084BC-L	7.8ft (2.4m), fit for Nellcor OxiSmart probes, and Medlinket S0010 probes	Nellcor OxiSmart	B4
<b>Compatible Biolight (China)</b>							
Q5, A2 E EMS				S0515DO-L (2019)	7.8ft (2.4m), fit for Medlinket S0165 probes	Digital Sensor	B9
M6, M12, M69 (new version), M8000, M9000				S0029BC-L	7.8ft (2.4m), fit for BCI probes, and Medlinket S0076 probes	BCI	B4
M8000				S0155DO-L	7.8ft (2.4m), fit for BCI probes, and Medlinket S0076 probes	Digital Sensor	B4
A6				S0165DO-S (2018)	4ft (1.2m), fit for Medlinket S0165 probes	Digital Sensor	B7
				S0165DO-L	7.8ft (2.4m), fit for Medlinket S0165 probes	Digital Sensor	B7

OEM Manufacturer & Models	Instrument Connector	Yoke Connector (Sensor side)	OEM#	Order Code	Descriptions	Compatible Sensor Tech.	Price
<b>Compatible Creative(China)</b>							
PC5000,PC9000				S0160NE-L	7.8ft (2.4m),fit for S0160 probes	Digital Sensor	B4
Up-7000	<b>NEW</b> 			S0562NE-S	4.9ft (1.5m),fit for Nellcor sensor and Medlinket S0010 probes	Nellcor	B7
<b>Compatible Contec(China)</b>							
CMS-7000				S0155NE-L	7.8ft (2.4m), fit for BCI probes	BCI	B4
GSM9000				S0155DO-L	7.8ft (2.4m),fit for Medlinket S0160 probes	Digital Sensor	B4
<b>Compatible Comen (China)</b>							
Comen C50				S0554DO-L (2019)	7.8ft (2.4m),fit for Comen C50	Digital Sensor	C0
Comen C100A				S0546NE-L	7.8ft (2.4m),fit for Comen C100A	Nellcor OxiSmart	B9
C30/C50/C60/C80			040-000243-00	S0568OX-L	7.8ft (2.4m),fit for Comen C100A	Nellcor-Oximax	B9
C30/C50/C60/C80			040-000313-00	S0569CS-L	7.8ft (2.4m),fit for Comen C100A	LNCS Masimo Rainbow Tech	B9
<b>Compatible Colin (Omron)</b>							
Omron>Colin:BP-306,BP-508,BP-808,BP-88,BP-88S,Press-Mate				S0008CO-L	7.8ft (2.4m),fit for Nellcor OxiSmart probes and Medlinket S0010 probes	Nellcor OxiSmart	D2
<b>Compatible Corpuls</b>							
Corpuls 08/16,08/16M				S0138CS-L	7.8ft (2.4m),fit for Masimo LNOP probes and Medlinket S0153 probes	Masimo LNCS	B9

OEM Manufacturer & Models	Instrument Connector	Yoke Connector (Sensor side)	OEM#	Order Code	Descriptions	Compatible Sensor Tech.	Price
<b>Compatible Criticare (CSI)</b>							
503 Spot, 506 Spot CSI, 507SD, 8100E, 8100EP			518DD	S0044BC-L	7.8ft (2.4m), fit for CSI probes	CSI	B4
<b>Compatible Dolphin</b>							
Dolphin ONE Oximeters			110	S0099BC-L	7.8ft (2.4m), fit for Dolphin probes	Dolphin	B7
<b>Compatible Datascope</b>							
Accusat, Accutorr 3 SAT/4 SAT/Plus, Passport Passport 2/2LT/IL/XG/XL			0012-00-0516-02	S0052BC-L	7.8ft (2.4m), fit for Datascope probes	Datascope Sensor	B9
<b>Compatible Edan (China)</b>							
Edan: M3A, M3B, M50, M8, M80, M8A, M8B, M9, M9A, iM50, iM60, iM8, iM80 without Nellcor OxiMax, technology, iM8A, iM8B, iM9, iM9A, Datascope Models see Datascope			Datascope P/N: 0010-20-42594	S0040NE-L	7.8ft (2.4m), fit for BCI/Nellcor probes and Medlinket S0076 /S0010 probes	Nellcor OxiSmart	B4
(Nellcor Oximax) M9, M99A, M8, M8A, M8B M3, M3B, H100B, H100N			MS1-30131	S0432OX-L	7.8ft (2.4m), fit for Nellcor probes and Medlinket S0026 probes	Nellcor OxiSmart	B9
<b>Compatible Emtel</b>							
Emtel: Fx2000				S0178OX-L	7.8ft (2.4m), fit for Nellcor probes and S0010 probes	Nellcor OxiSmart	B9
<b>Compatible GE-Datex Ohmeda</b>							
3775, 37xx Series, 3800, 3900, 3900P, 4700, 5250			TS-H3	S0528TS-L (2018)	7.8ft (2.4m), fit for Medlinket S0190 probes or Trusignal probes	GE OxyTip+ Sensor	B7
AS/3 with M-OSAT module, CS/3 with M-OSAT module, Cardiocap/5, S/5 with M-OSAT module, TuffSat			OXY-OL3	S00140H-L	7.8ft (2.4m), fit for Ohmeda probes	GE OxyTip+ Sensor	B9
AS/3, CS/3, Capnomac Ultima, Cardiocap S/5 Light Monitor, Cardiocap/5, S/5, Satellite, Plus II, TruSignal			TS-N3	S0529TS-L (2018)	7.8ft (2.4m), fit for Trusignal probes	GE OxyTip+ Sensor	B7

OEM Manufacturer & Models	Instrument Connector	Yoke Connector (Sensor side)	OEM#	Order Code	Descriptions	Compatible Sensor Tech.	Price
<b>Compatible GE-Datex Ohmeda</b>							
TruSat, TruSat TD; Sensor solutions for GE Ohmeda TruSat™ pulse oximeter			OXY-MC3	S0127OH-L	7.8ft (2.4m), fit for Ohmeda probes	GE OxyTip+ Sensor	B7
TruSat, TruSat TD			OXY-MC3	S0527TS-L (2018)	7.8ft (2.4m), fit for Medlinket S0190 series or Trusignal probes	TruSignal	B7
Datex-Ohmeda: AS/3, CS/3, CH/S, CH/2 S, CH-RS, CG/2S, Cardiocard I, Cardiocard II, Cardiocard 5, Capnomac Ultima, Light Monitor, M-Estpr, Oscar II, OSP-200, Satlite Trans, Satlite TransPlus, ULTSVI, UL TSVO, ULTSIO, ULTS0 0			OXY-C3	S0036BC-L	7.8ft (2.4m), fit for DATEX probes	Datex	C4
			OXY-SL3	S0036OH-L	7.8ft (2.4m), fit for DATEX probes	Datex Oxytip	B9
			S0036NE-L	7.8ft (2.4m), fit for Medlinket S0010 probes	Nellcor OxiSmart	C4	
<b>Compatible GE Healthcare-Marquette</b>							
Dash 2500, 3000, 4000, 5000, Dash Series, Eagle, PDM ,Module, Procure B40, SOLAR, Solar 8000, 8000M, TRAM Modular, Tram 451, i/9500, x50SL Series, Carescape B650, B850, V100			2006644-001 407252-002, E9004DE, E9004GE	S0002NE-L	7.8ft (2.4m), fit for NELLCOR sensor and Medlinket S0010 probes	Nellcor OxiSmart	A0
Datex Ohmeda: Giraffe Infant Warmer, S/5; GE Healthcare > Corometrics: 128, 250, 250cx, 259, TRAM 450SL; GE Healthcare > Critikon > Dinamap: Carescape B650, Carescape B850, Carescape V100, Carescape V100 with Masimo technology; GE Healthcare > Marquette: CardioLab, Dash 3000, Dash 4000, Dash 5000, Dash Series, Eagle, MAC-Lab, PDM Module, Procure B40, SOLAR, Solar 8000, Solar 8000M, Solar Series, TRAM Modular, Tram 451, i/9500, x50SL Series			2002592-001, 2017002-00 (3.6 Meters), 2017002-003, 2017002-002, 2016041-00,	S0025MA-L	7.8ft (2.4m), fit for Masimo LNOP sensor and Medlinket S0020 probes	Masimo LNOP	C3
			2016, 2264 MAC-GE LNC-10-GE	S0025CS-L	7.8ft (2.4m), fit for Masimo LNCS probes and Medlinket S0204, S0153 probes	Masimo LNCS	C3
			2655	S0025RD-L	7.8ft (2.4m), fit for Medlinket S0450 probes	Masimo RD SET	C5
				S0025CO-L	7.8ft (2.4m), fit for NELLCOR probes and Medlinket S0010B-S	Nellcor OxiSmart	C7















OEM Manufacturer & Models	Instrument Connector	Yoke Connector (Sensor side)	OEM#	Order Code	Descriptions	Compatible Sensor Tech.	Price
<b>Compatible GE Healthcare-Marquette</b>							
Dash 2500,3000,4000,5000 ,Dash Series,Eagle PDM Module,Procure B40,SOLAR,Solar 8000,8000M,TRAM Modular,Tram 451,,i/9500,x50SL Series,Carescape B650,B850,V100			2021406-001 2025350-001 2021406-002	S0122OX-L	7.8ft (2.4m),fit for NELLCOR OXimax probes	Nellcor Oximax	B9
				S0122CO-L	7.8ft (2.4m),fit for Nellcor sensor and Medlinket S0026 probes	Nellcor Oximax	B9
Datex Ohmeda: E- PRESTN, S/5 with E- series modules, TruSignal, i4 with E- series modules;GE Healthcare > Corometrics: 259;GE Healthcare > Critikon > Dinamap: Carescape B650, Carescape V100;GE Healthcare: Aisys, Aisys CS2			OXY-ES3	S0128OH-L	7.8ft (2.4m),fit for Ohmeda sensor and Medlinket S0123 probes	GE OxyTip+ Sensor	B9
				S0194NE-L	7.8ft (2.4m),fit for Medlinket S0194 probes	Datex Ohmeda	C3
Datex Ohmeda: E- PRESTN, S/5 with E- series modules, TruSignal, i4 with E- series modules;GE Healthcare > Corometrics: 259;GE Healthcare > Critikon > Dinamap:Carescape B650, Carescape V100			TS-G3	S0190TS-L	7.8ft (2.4m),fit for Medlinket S0190B-S probes	GE OxyTip+ Sensor	B7
							
<b>Compatible Goldway (China)</b>							
Goldway:UT4000A, UT4000C 4000B PACE TECH				S0007BC-L	7.8ft (2.4m),fit for BCI /Nellcor sensoi and Medlinket S0076 /S0010 probes	Nellcor OxiSmart	B4
<b>Compatible Tianjin FUSITE(China)</b>							
FM6501-M				S0559CO-L	7.8ft (2.4m),fit for S0160 probes	Digital Sensor	B4

OEM Manufacturer & Models	Instrument Connector	Yoke Connector (Sensor side)	OEM#	Order Code	Descriptions	Compatible Sensor Tech.	Price
<b>Compatible Guoteng (China)</b>							
GT9000				S0024NE-L	7.8ft (2.4m),fit for Nellcor sensor and Medlinket S0010 probes	Nellcor OxiSmart	B4
<b>Compatible Hellige</b>							
Servomed 4.Generation, SCP 844,851,852;SCS 804; SMK151,153,154,155-1, 156,157,SMK181,182,S MV,104T,107,111,168;S MS316;SMC108;SMV10 4,Servomed N4,Servocard,Serie Cardioserv,Vicom SM,SMU 511,611,612,630 Series, SMK200,SMK210,211,23 0,231,240,250,SMP3003 10, Pepita 201,202,202R,203, Pepita203,R204,204R,20 5,Pepita 205R			30344358	S0006NE-L	7.8ft (2.4m),fit for Nellcor sensor and Medlinket S0010 probes	Nellcor OxiSmart	B9
<b>Compatible Huntleigh/Healthcare</b>							
Huntleigh Healthcare				S0147NE-L	7.8ft (2.4m),fit for Nellcor sensor and Medlinket S0010 probes	Nellcor OxiSmart	B7
<b>Compatible Hexin Zongdan (China)</b>							
ZD Series patient monitor				S0150NE-L	7.8ft (2.4m),fit for S0010 probes	Nellcor OxiSmart	B4
<b>Compatible Masimo</b>							
Masimo:Rad-8 Datascope:Medtronic Welch Allyn:Zoll: (Must be Masimo Module)			LNC MAC-395	S0020CO-L	7.8ft (2.4m),fit for NELLCOR sensor and Medlinket S0010 probes	Nellcor OxiSmart	C5
Rad-5,Rad-8 Datascope,Medtronic, Welch Allyn,Zoll, GE Healthcare (Must be Masimo Module)			1814 (LNC-10)	S0020CS-L	7.8ft (2.4m),fit for Masimo LNCS sensor and Medlinket S0153 probes	Masimo LNCS	C0
				S0204CS-L	7.8ft (2.4m),fit for Masimo LNCS sensor and Medlinket S0442 probes	Masimo LNCS (with chip)	C3
Rad-8 Atom,Datascope,Medtronic Welch Allyn,Zoll (Must be Masimo Module)			1173 (PC04)	S0020MA-L	7.8ft (2.4m),fit for Masimo LNOP sensor and Medlinket S0020 probes	Masimo LNOP	C0

OEM Manufacturer & Models	Instrument Connector	Yoke Connector (Sensor side)	OEM#	Order Code	Descriptions	Compatible Sensor Tech.	Price	
<b>Compatible Masimo</b>								
<b>NEW</b>				S0153NE-A	200mm, fit for NELLCOR sensor and Medlinket S0010 probes	Nellcor OxiSmart	C0	
Pronto-7, Rad-5, Rad-57, Rad-8, Rad-87, Radical-7 Medtronic: Lifepak 15 Zoll: X Series			2055 (Red LNC-04)	S0442CS-L	7.8ft (2.4m), fit for Medlinket S0204 probes	Masimo LNCS (with chip)	C8	
			<b>NEW</b>	S0442CS-S	4ft (1.2m), fit for Medlinket S0204 probes		C8	
			4104	<b>NEW</b>	S0442RD-L	7.8ft (2.4m), fit for Medlinket S0450 probes	Masimo RD	C5
			2406/2404	<b>NEW</b>	S0442MS-L	7.8ft (2.4m), fit for Medlinket S0540 probes	Masimo LNCS	C8
Rad-5, Rad-57, Rad-8, Rad-87, (Compatible Masimo Tech)				S0543NE-S	9in. (210mm), fit for Medlinket S0010 probes	Nellcor OxiSmart	C0	
			Rainbow@ RC-1 Rainbow@ RC-4 Rainbow@ RC-12	<b>NEW</b> S0540NE-S	Adapter Cable, 100mm, fit for S0010 probes	Nellcor OxiSmart	A8	
<b>Compatible MEK (Korea)</b>								
MIS3AH_1 TYPE: MEK (CSI Module)			MP1000 NT	S0115BC-L	7.8ft (2.4m), fit for MEK probes	MEK	B7	
MP1000, (Nellcor Module)				S0144NE-L	7.8ft (2.4m), fit for Nellcor probes	Nellcor OxiSmart	B7	
<b>Compatible Mennen Medical</b>								
Mennen				S0103NE-L	7.8ft (2.4m), fit for Nellcor sensor and Medlinket S0010 probes	Nellcor OxiSmart	B7	
<b>Compatible Mindray (China)</b>								
For old PM 6000 only				S0013CO-1	7.8ft (2.4m), fit for Masimo sensor and Medlinket S0153 probes	Masimo LNCS	B7	
DPM4, DPM5, PM 7000, PM 8000, PM 9000, Trio			0010-20-42595	S0129NE-L	7.8ft (2.4m), fit for Nellcor sensor and Medlinket S0026 probes	Nellcor Oximax	B7	

OEM Manufacturer & Models	Instrument Connector	Yoke Connector (Sensor side)	OEM#	Order Code	Descriptions	Compatible Sensor Tech.	Price
<b>Compatible Mindray(China)</b>							
(Mindray Module) PM,MEC series monitors, VS-800 vital signs monitor			0010-20-42594	S0040NE-L	7.8ft (2.4m),fit for NELLCOR probes or Mindray 512 probes and Medlinket S0010 probes	Nellcor OxiSmart	B9
DPM4,PM 6000,PM 7000, PM 8000,PM 9000,VS 800, DPM3,DPM5				S0116CO-L	7.8ft (2.4m),fit for NELLCOR probes and Medlinket S0010B-S	Nellcor OxiSmart	B0
			0010-30-42625 115-023136-00	S0116CS-L	7.8ft (2.4m),fit for Masimo probes and Medlinket S0153 probes	Masimo LNCS	B9
(Mindray Module) DPM7,PM-5000,PM-6000, PM-8100 DPM 6			0010-21-11957	S0045OX-L	7.8ft (2.4m),fit for NELLCOR probes and Medlinket S0010 probes	Nellcor OxiSmart	B9
(Mindray Module)Accutorr 3 Accutorr 7,Beneheart D6, BeneView T5,BeneView T8, DPM6,DPM7,Passport 12, Passport 8,PM 6800, BeneView T1,MEC 12,MPM			0010-20-42710	S0125CO-L	7.8ft (2.4m),fit for NELLCOR probes and Medlinket S0010 probes	Nellcor OxiSmart	B9
(Mindray Module) BeneView T5/T6/T8, Beneheart D6,DPM6,DPM7				S0126CO-L	7.8ft (2.4m),fit for NELLCOR sensor and Medlinket S0010 probes	Nellcor OxiSmart	C5
(M-TECH Module) BeneView T5/T6/T8, Beneheart D6,DPM6,DPM7			0010-30-42738	S0126CS-L	7.8ft (2.4m),fit for Masimo probes and Medlinket S0153 probes	Masimo LNCS	B9
(Mindray Interface Nellcor Module) Accutorr 3, Accutorr 7, BeneView T1, BeneView T5, BeneView T8, Beneheart D6, DPM6, DPM7, MEC 12, MPM, PM 6800, Passport 12, Passport 8			0010-20-42712	S0126OX-L	7.8ft (2.4m),fit for Nellcor probes and Medlinket S0026 probes	Nellcor Oximax	B9
MINDRAY BENEVISION N				S0126NE-L	7.8ft (2.4m),fit for NELLCOR probes and Medlinket S0010 probes	Nellcor Oximax	B9
(Mindray Interface Masimo Module)Mindray Accutorr 3/7,BeneView Series(T1/T5/T8),Beneheart D6,DPM6,DPM7,MEC 12,MPM,PM 6800,Passport 12,Passport 8,BeneVision Series Monitor			115-020768-00 040-000332-00	S0199CS-L	7.8ft (2.4m),fit for Masimo probes and Medlinket S0153 /S0442 probes	Masimo LNCS (with chip)	C3
			040-003310-00	<b>NEW</b> S0199RD-L	7.8ft (2.4m),fit for Medlinket S0450 probes	Masimo RD	C5



















OEM Manufacturer & Models	Instrument Connector	Yoke Connector (Sensor side)	OEM#	Order Code	Descriptions	Compatible Sensor Tech.	Price
<b>Compatible Mindray (China)</b>							
(Masimo Module) Accutor V, Accutorr Plus, Accutorr V, Duo, EPM4, Passport 2, Passport 2LT, Passport V, Passport XG, Spectrum, Spectrum OR, Trio, V12,				S0204CS-L	7.8ft (2.4m),fit for Masimo LNCS sensor and Medlinket S0442 probes	Masimo LNCS (with chip)	C3
(Nellcor Module)Passport 2, Passport V,Spectrum, Spectrum OR,V-Series			0012-00-1254	S0117OX-L	7.8ft (2.4m),fit for Nellcor sensor and Medlinket S0026B-S	Nellcor Oximax	B7
<b>Compatible M&amp;B(China)</b>							
M&B:CD2000				S0093NE-L	7.8ft (2.4m),fit for NELLCOR sensor Medlinket S0010B-S	Nellcor OxiSmart	B9
<b>Compatible Midmark Catdeli</b>							
				<b>NEW</b> S0582OX-L	7.8ft (2.4m)	Nellcor OxiSmart	B0
<b>Compatible Nellcor OxiSmart</b>							
N-3000,N-390,N-395,N-6000, NPB-290,NPB-295,Symphony N-3000,Datex Ohmeda,GE Healthcare,Invivo,Medtronic, Datascope,Nihon Kohden,Colin, Oridion,Philips,Welch Allyn			SCP-10, MC-10	S0001NE-L	7.8ft (2.4m),fit for Nellcor sensor	Nellcor OxiSmart	B7
Covidien > Nellcor: N-100, N-180, N-20, N-200, NPB-40, NPB-75; GE Healthcare > Corometrics: 129, 188; GE Healthcare > Critikon > Dinamap: 1000, 9700, 9710, 9720 Plus, Compact, MPS, Pro 300, Pro 400, Select; Invivo: Escort II OPT30, Prism;Ivy Biomedical: 405P, 405T; Mindray > Datascope: Expert, Passport, Passport XG; Nonin: 8500, 8604; Suntech: 247B; Welch Allyn: Propaq 106-EL, Propaq 202-EL, Propaq 204-EL, Propaq 206-EL, Propaq CS, Series 420 monitors			Nellcor OxiSmart Adapter	S0010NE-S	4ft (1.2m),fit for Nellcor sensor	Nellcor OxiSmart	A7
			Nellcor OxiSmart Adapter	S0010NE-L	7.8ft (2.4m),fit for Nellcor sensor	Nellcor OxiSmart	A8
<b>Compatible Nellcor Oximax</b>							
N-550,N-560,N-595,N-600, N-600x,Oximeters that require Nellcor OxiMax sensors			DOC-10	S0117OX-L	7.8ft (2.4m),fit for Nellcor sensor and Medlinket S0026B-S	Nellcor Oximax	B9
<b>Compatible Nellcor OxiSmart</b>							
Nellcor N595/N600				S0117NE-L	14PIN>DB9F, 7.8ft (2.4m), fit for Nellcor sensor and Medlinket S0010 series probes	Nellcor OxiSmart	B7
<b>Compatible Medlinket Multi-compatible SpO2</b>							
Nellcor 595/600/600X				S0117MU-L	7.8ft (2.4m),fit for Medlinket 601481632	Medlinket Multi-compatible	B9







OEM Manufacturer & Models	Instrument Connector	Yoke Connector (Sensor side)	OEM#	Order Code	Descriptions	Compatible Sensor Tech.	Price
<b>Compatible Nellcor Oximax</b>							
Nellcor: N550, N-595 GE: Dinamap PRO (w/Oxi), Schiller, Include N-600x, GE Dash Series patient monitor(Oximax mould), as 1800, 2500, 3000, CARESCAPE. Include Spacelabs mCare 300 Vital Signs Monitor(Oximax mould), as 91220 series			Oximax adapter	S0026NE-A	DB9M to DB9M, suitable for use with S0010 or S0026 probes	Nellcor Oximax	C3
N-10, N-180, N-190, N-20, N-30, N-560, N-600, N-600x, N-65, N-85, NPB-190, NPB-195, NPB-3910, NPB-3920, NPB-3930, NPB-3940, NPB-40, NPB-4000, NPB-75, PM10N, Sensors that have Nellcor Oximax Technology and 9 pins			DEC-4, 41251, EC-4	S0026OX-S	4ft (1.2m), fit for Nellcor oximax sensor, as S0026B-S	Nellcor Oximax	B7
			DEC-8	S0026OX-L	7.8ft (2.4m), fit for Nellcor oximax sensor and Medlinket S0026B-S	Nellcor Oximax	B7
<b>Compatible Nihon Kohden</b>							
OPV-1500 Life Scope N			JL-302T	S0159NI-L	7.8ft (2.4m), fit for Nihon Kohden sensor and Medlinket S0005 probes	Nihon Kohden	B9
2303 Life Scope I, 2353 Life Scope L, 4103, 4111, 4113 Life Scope P, 5135 Life Scope A, BSM-2300 Life Scope I, BSM-2301, BSM-2301A, BSM-2351, BSM-4100 Life Scope P, BSM-4101, BSM-5100 Life Scope A, BSM-5105, BSM-6000 series, BSM-6301K, BSM-6501K, BSM-6701K BSM-9510 Life Scope M, BSM-9800 Life Scope S, Life Scope TR			JL-900P	S0005NI-L	7.8ft (2.4m), fit for Nihon Kohden sensor and Medlinket S0005 probes	Nihon Kohden	B9
				S0005MU-L	7.8ft (2.4m), fit for Medlinket 601481632	Medlinket Multi-compatible	B9
AY-651P, AY-653P, BSM-1753, BSM-3572, BSM-6000 series, BSM-6310K, BSM-6501K, BSM-6701K, Life Scope TR			4191	<b>NEW</b> S0005RD-L	7.8ft (2.4m), fit for Medlinket S0450 Probes	Masimo RD	C5
				JL-650P	S0005OX-L	7.8ft (2.4m), fit for Nellcor sensor and S0026 Probes	Nellcor Oximax
Nihon Kohden SVM-7501; SVM7503; SVM-7521, SVM-7523, SVM-7601, SVM7603, SVM-7621, SVM-7623			JL-701P	S0561NI-L	7.8ft (2.4m), fit for S0005 Probes	Nihon Kohden 9pin 40° to DB9F	B9

OEM Manufacturer & Models	Instrument Connector	Yoke Connector (Sensor side)	OEM#	Order Code	Descriptions	Compatible Sensor Tech.	Price
<b>Compatible Novamatrix</b>							
2001,500,505,510,511,515,515A,515B,515C,520,520A,7000,7100,7200,7300, Oxypleth				S0062NE-L	7.8ft(2.4m),fit for Medlinket S0062 probes	Novamatrix	B7
<b>Compatible Shanghai NuoCheng (China)</b>							
NTS3000				S0192NE-L	7.8ft (2.4m),fit for Medlinket S0010 probes	Nellcor OxiSmart	C6
NTS-3000B				S0438NE-L	7.8ft (2.4m),fit for Medlinket S0010 probes	Nellcor OxiSmart	C6
<b>Compatible Neusoft (China)</b>							
Neusoft				S0003OX-L	7.8ft (2.4m),fit for NELLCOR sensor and Medlinket S0010 probes	Nellcor OxiSmart	B8
<b>Compatible Primedic (Yuwell)</b>							
PRIMEDIC				S0140NE-L	7.8ft (2.4m),fit for Medlinket S0010 probes	Nellcor OxiSmart	B7
			<b>NEW</b>	S01400X-L	7.8ft (2.4m),fit for Nellcor sensor and Medlinket S0026 probes	Nellcor Oximax	B0
<b>Compatible Philips</b>							
M2601A,M3000A,M3001A, M3001AA01, M3001AA01C06 M3001AA01C12, M3001AA01C18,M3500 B, M4735A,MRx, SureSigns VS2, SureSigns VS3			M1943A M1943AL	S0015OX-L	7.8ft(2.4m),fit for NELLCOR sensor and Medlinket S0010 probes	Nellcor OxiSmart	B6
			M1941A	S0015PH-L	7.8ft (2.4m),fit for Philips sensor and Medlinket S0015 probes	Philips	B6
78352A,78352C,78833A, 78833C,78834A,M1020A, M1722A/B,M1732A/B, M2475B			M1900B	S0003OX-L	7.8ft (2.4m),fit for Nellcor sensor and Medlinket S0010 probes	Nellcor OxiSmart	B0
			M1940A M1940B	S0003PH-L	7.8ft (2.4m),fit for Philips sensor and Medlinket S0015 probes	Philips	B8

OEM Manufacturer & Models	Instrument Connector	Yoke Connector (Sensor side)	OEM#	Order Code	Descriptions	Compatible Sensor Tech.	Price
<b>Compatible Philips</b>							
Heartstream XL, IntelliVue, IntelliVue FAST-SpO2, IntelliVue MP2, IntelliVue MP70, IntelliVue MX450, M1020B, M2601A, M3000A, M3001A, M3001A A02, M3001A A02C06, M3001A A02C12, M3001A A02C18, M3001A A04, M3001A A04C06, M3001A A04C12, M3001A A04C18, M3002A, M3002A MMS X2, M3500B, M4735A, M8102A, M8102A MP2, M8105A MP5, M8105AS, SureSigns VS2, SureSigns VS3, SureSigns VS4, VM4			M1943NL 989803 136591	S0414OX-L	7.8ft (2.4m), fit for Nellcor sensor and Medlinket S0026 probes	Nellcor Oximax	B7
			9898031 48221	S0197CS-L	7.8ft (2.4m), fit for Masimo sensor and Medlinket S0153 probes	Masimo LNCS	C3
			4083 <b>NEW</b>	S0197RD-L	7.8ft (2.4m), fit for Medlinket S0450 probes	Masimo RD	C5
			M1020-61100	S0197MA-L	7.8ft (2.4m), fit for Masimo sensor and Medlinket S0020 probes	Masimo LNOP	C3
Efcia CM100			3345	S0594CS-L	7.8ft (2.4m), fit for Medlinket S0442 probes	Masimo LNCS	C5
			4106	S0594RD-L	7.8ft (2.4m), fit for Medlinket S0450 probes	Masimo RD	C5
			3342	S0594MS-L	7.8ft (2.4m), fit for Medlinket S0540 probes	Masimo LNCS	C5
<b>Compatible Ruibo</b>							
PM9000A <b>NEW</b>				S0051CO-L	8ft(2.43m), fit for Medlinket 901451082	Digital Tech.	B7
PM-9000GTA <b>NEW</b>				S0096MU-L	8.2ft(2.5m), fit for Medlinket 901451082	Digital Tech.	B7
<b>Compatible Schiller</b>							
Schiller Argus TM-7				S0028NE-L	7.8ft (2.4m), fit for Nellcor sensor	Nellcor OxiSmart	A9
Argus Pro, Argus LCM				S0118MA-L	7.8ft (2.4m), fit for Masimo sensor	Masimo LNOP	B6

OEM Manufacturer & Models	Instrument Connector	Yoke Connector (Sensor side)	OEM#	Order Code	Descriptions	Compatible Sensor Tech.	Price
<b>Compatible Siemens/Drager</b>							
(Nellcor Oximax Module) Infinity Delta, Infinity Gamma Infinity Kappa, Infinity MultiMed Pod, Infinity Vista				S0072OX-L	7.8ft (2.4m), fit for Nellcor sensor and Medlinket S0026 probes	Nellcor Oximax	B6
				S0072OX-S	4ft (1.2m), fit for Nellcor sensor and Medlinket S0026 probes	Nellcor Oximax	B6
(Masimo Module) Infinity Delta, Infinity Gamma Infinity Kappa, Infinity MultiMed Pod, Infinity Vista			MS18680	S0072MA-S	4ft (1.2m), fit for NELLCOR sensor and Medlinket S0020 probes	Masimo LNOP	D5
			MS17041	S0072MA-L	7.8ft (2.4m), fit for NELLCOR sensor and Medlinket S0020 probes	Masimo LNOP	C3
<b>Compatible Siemens/Drager</b>							
Cicero, Infinity Delta XL, Infinity Gamma XL Infinity Kappa, Julian, Vitalert 1000			MS17041	S0119NE-L	7.8ft (2.4m), fit for Nellcor sensor and Medlinket S0010 probes	Nellcor OxiSmart	H0
(Nellcor Module) Infinity Delta, Infinity Gamma, Infinity Kappa, Infinity MultiMed Pod, Infinity Vista, SC 6002XL, SC 7000, SC 8000, SC 9000XL			3368433	S0072BC-S	4ft (1.2m), fit for NELLCOR sensor and Medlinket S0010 probes	Nellcor OxiSmart	B5
			3375834	S0072BC-L	7.8ft (2.4m), fit for NELLCOR sensor and Medlinket S0010 probes	Nellcor OxiSmart	B6
(Masimo Module) Infinity Delta, Infinity Gamma, Infinity Kappa, Infinity MultiMed Pod, Infinity Vista			MS24303	S0072CS-S	4ft (1.2m), fit for Masimo sensor and Medlinket S0153 probes	Masimo LNCS	C3
			MS17522	S0072CS-L	7.8ft (2.4m), fit for Masimo sensor and Medlinket S0153 probes	Masimo LNCS	C3
				MS34437	<b>NEW</b> S0072RD-L	7.8ft (2.4m), fit for Medlinket S0450 probes	Masimo RD

OEM Manufacturer & Models	Instrument Connector	Yoke Connector (Sensor side)	OEM#	Order Code	Descriptions	Compatible Sensor Tech.	Price
<b>Compatible Spacelabs</b>							
466, 90303B, 90308, 90309,90343, 90351-0/6, 90369, 90465, 90489, 90651A, 90651A-08, 91343, IM77, Scout			700-0020-00	S0035NE-L	7.8ft (2.4m),fit for Nellcor sensor and Medlinket S0010 probes	Nellcor OxiSmart	B7
1050, 1600, 1700, 90369, 90469, 90496 Ultraview			700-0030-00	S0004NE-L	7.8ft (2.4m),fit for Nellcor sensor and Medlinket S0010 probes	Nellcor OxiSmart	B7
1050, 1600, 1700, 90369, 90469, 91220-B, 904, 96, Ultraview and Ultraview SL with Oximax technology			700-0792-00	S0004OX-L	7.8ft (2.4m),fit for Nellcor sensor and Medlinket S0026 probes	Nellcor Oximax	B9
SpaceLab SpaceLab Xprezzon 91393			700-0789-00	S0550MA-L (2018)	7.8ft (2.4m),fit for Medlinket S0020 probes	Masimo LNOP	D5
<b>Compatible Spacelabs</b>							
SpaceLab Xprezzon 91393,91367			700-090600	S0549CS-L (2018)	7.8ft (2.4m),fit for Medlinket S0153 probes	Masimo LNCS	C3
<b>Compatible Sunmind (China)</b>							
Sunimind KP-930/930F				S0141NE-L	7.8ft (2.4m),fit for NELLCOR sensor and Medlinket S0010 probes	Nellcor OxiSmart	B6
<b>Compatible SIMED</b>							
Baxter:ASAT SiMED:S-50 SiMED:S-100 SiMED:S-100e			600015	S0120NE-L	7.8ft (2.4m),fit for NELLCOR sensor and Medlinket S0010 probes	Nellcor OxiSmart	B9
<b>Compatible Wego (China)</b>							
M3512				S0175NE-L	7.8ft (2.4m),fit for Medlinket S0010 probes	Nellcor OxiSmart	B7
<b>Compatible Winziss</b>							
Winziss				S0537NE-L (2018)	7.8ft (2.4m),fit for Medlinket S0010 probes	Nellcor OxiSmart	B4

OEM Manufacturer & Models	Instrument Connector	Yoke Connector (Sensor side)	OEM#	Order Code	Descriptions	Compatible Sensor Tech.	Price
<b>Compatible Welch Allyn</b>							
PIC30/PIC40/PIC50 (Nellcor Oximax Module)				S0565OX-L	7.8ft (2.4m), fit for Nellcor sensor and Medlinket S0026 probes	Nellcor Oximax	A9
<b>Compatible Zhong Heng Sheng</b>							
MMED6000DPM/M10 KD580				S0169NE-L	7.8ft (2.4m), fit for Nellcor sensor and Medlinket S0010 probes	Nellcor OxiSmart	A9
<b>Compatible 3F/Comen/CSI</b>							
Comen:STAR-1000; LANKE:LK-8600A;3F: DIONA PMS-8100;CSI: RADO 4200;MAYTAG: MTK-2000				S0021BC-L	7.8ft(2.4m), fit for BCI sensor or Medlinket S0010 probes	Nellcor OxiSmart	A9



## EtCO2 Sensor & Accessories

### Product Introduction

Medlinket provides a cost-effective EtCO<sub>2</sub> monitoring program for clinical practice. It is plug-in and play. Advanced non-spectrophotometric infrared technology can be used to measure the instantaneous CO<sub>2</sub> concentration, respiratory rate, end-tidal CO<sub>2</sub> value and inspired CO<sub>2</sub> concentration of the measured object.

### Application Field

1. Monitoring the patient's respiratory status;
2. Assists in determining when to intubate or extubate;
3. Verification of ET tube placement;
4. Alerts if accidental extubation occurs;
5. Ventilator disconnect detection;
6. Verification of ventilation during transport.

## Clinical Significance

EtCO<sub>2</sub> monitoring has great application value and significance to the clinical. EtCO<sub>2</sub> monitoring device is a quite valuable alarming system with timely, accurate detection of some incidents and severe combinations to avoid the occurrence of severe hypoxia injury. It can dramatically improve the safety of surgery and anesthesia, which not only benefits the patients, but protects the safety of the clinical personnel themselves.

1. External: American Society of Anesthesiologists (ASA) requires that all the patients under anesthesia should be set for EtCO<sub>2</sub> and SpO<sub>2</sub> monitoring.
2. Internal: the partial pressure of EtCO<sub>2</sub> has been considered as another basic vital sign besides body temperature, respiratory rate, heart rate, blood pressure, electrocardiogram, and arterial oxygen saturation.

## Product Features

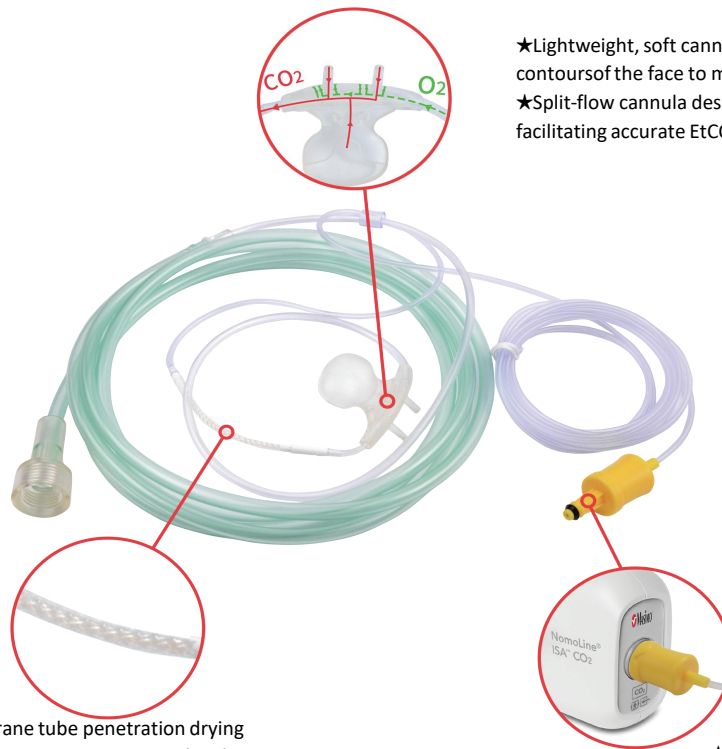



















- ★Lightweight, soft cannulas with a curved design fit the contour of the face to minimize pressure
- ★Split-flow cannula design reduces gas mixing, facilitating accurate EtCO<sub>2</sub> measurements











- ★Unique membrane tube penetration drying technology to ensure moisture removal and protection of equipment
- ★Compatible with low humidity sampling lines, it can effectively prolong the use time of sampling lines (≤ 120h)





- ★Compatible NomoLine (ISA) CO<sub>2</sub> Sidestream Gas Analyzer Modules











OEM Manufacturer & Models	Ref Picture	OEM #	Order Code	Descriptions	Pice
<b>Water Trap Series</b>					
<b>Compatible Mindray (China)</b>					
For BeneView, iPM, iMEC, PM, MEC-2000 series monitors, PM-9000/7000/6000 series, BeneHeart defibrillator		115-043022-00 (9200-10-10530)	CCA109	Dryline water trap Adult/Pediatirc for dual-slot module, 10pcs/box	A6
		115-043023-00 (9200-10-10574)	CCA209	Dryline water trap Neonatal for dual-slot module, 10pcs/box	A6
For BeneVision, BeneView series monitors		115-043024-00 (100-000080-00)	CCA110	Dryline II water trap Adult/Pediatirc for single-slot module, 10pcs/box	A7
		115-043025-00 (100-000081-00)	CCA210	Dryline II water trap Neonatal for single-slot module, 10pcs/box	A7
<b>Compatible GE</b>					
GE Solar Sidestream EtCO2 Module, GE MGA-1100 Mass Spectrometer GE Advantage System, EtCO2 Sampling Systems		402668-008	CA20-013	Single patient use 0.8 micron Fitter, standard Luer Lock, 20pcs/box	B2
The monitors of GE Healthcare are compatible with gas modules such as E-CAiO, E-CAiOV and E-CAiOVX.		D-FEND/876446	CCC006	standard Luer Lock, 25pcs/box	
compatible with E - CAiO, E - CAiOV, E - CAiOVX, E - sCAiOE and N - CAiO		D-Fend Pro/M1182629	CCC007	standard Luer Lock, 25pcs/box	
GE Healthcare gventilator, monitor, anesthesia machine with E-miniC gas module		8002174	CA20-053	Internal Container volume is > 5.5mL, 25pcs/box	A7
<b>Compatible Drager</b>					
Compatible Drager Babytherm 8004/8010 Babylog VN500		6872130	WL-01	Single patient use Waterlock, 10pcs/box	B6
<b>Compatible Philips</b>					
Compatible Module: Philips - IntelliVue G5		M1657B / 989803110871	CA20-008	Philips water trap, 25pcs/box	C2
Compatible Philips			CA20-009	Philips water trap Rack	\
Compatible Module: Philips - IntelliVue G7 <sub>m</sub>		989803191081	WL-01	Single patient use Waterlock, 10pcs/box	\





Ref Picture	OEM #	Order Code	Descriptions	Pice
<b>Side-stream CO2 Accessories</b>				
	Mindray OEM #:115-043021-00 (9000-10-07487) Philips OEM#:13902A	CBF50000	Adult/Pediatric L Adapter, 25pcs/box	
	Mindray OEM #:115-043020-00 (9000-10-07486) Philips OEM #:M1612A	CBE50000	Adult/Pediatric T Adapter, 25pcs/box	
		CBF50112	Adult/Pediatric Sampling line L Adapter, 2.5m,15pcs/box	
		CBE50112	Adult/Pediatric Sampling line T Adapter, 2.5m,15pcs/box	
		CBE50132	Adult/Pediatric Sampling line T Adapter,with dryer, 2.5m,15pcs/box	
		CBE60112	Infant/Neonatal Sampling line T Adapter, 2.5m,15pcs/box	
		CBE60132	Infant/Neonatal Sampling line T Adapter,with dryer, 2.5m,15pcs/box	
	Mindray OEM #: 115-043017-00 (9200-10-10533)	CBG00112	Adult/Pediatric Single patient use Sampling line, 2.5m, 25pcs/box	
	Mindray OEM #: 040-002625-00	CBG00132	Adult/Pediatric Single patient use Sampling line with dryer, 2.5m,25pcs/box	
	Mindray OEM#: 115-043001-00 (MO2A-10-25937)	CBB10112	Adult Single patient use CO2 Sampling Nasal Cannula, 2.5m,25pcs/box	
	Mindray OEM #: 115-043002-00 (MO2A-10-25938)	CBB20111	Pediatric Single patient use CO2 Sampling Nasal Cannula, 2m,25pcs/box	
		CBB60111	Infant/Neonatal Single patient use CO2 Sampling Nasal Cannula, 2m,25pcs/box	
		CBB10132	Adult Single patient use CO2 Sampling Nasal Cannula with Dryer, 2.5m,25pcs/box	
		CBB20131	Pediatric Single patient use CO2 Sampling Nasal Cannula with Dryer, 2m,25pcs/box	
		CBB60131	Infant/Neonatal Single patient use CO2 Sampling Nasal Cannula with Dryer, 2m,25pcs/box	
		CBD10112	Adult CO2 Sampling Nasal/Oral Cannula, 2.5m,25pcs/box	
		CBD20112	Pediatric CO2 Sampling Nasal/Oral Cannula, 2.5m,25pcs/box	
		CBD60112	Infant/Neonatal CO2 Sampling Nasal/Oral Cannula, 2.5m,25pcs/box	









Ref Picture	OEM #	Order Code	Descriptions	Pice
		CBD10132	Adult CO2 Sampling Nasal/Oral Cannula,with Dryer, 2.5m,25pcs/box	
		CBD20132	Pediatirc CO2 Sampling Nasal/Oral Cannula,with Dryer, 2.5m,25pcs/box	
		CBD60132	Infant/Neonatal CO2 Sampling Nasal/Oral Cannula,with Dryer, 2.5m,25pcs/box	
		CBC10122	Adult CO2 Sampling Nasal Cannula with O2, 2.5m,20pcs/box	
		CBC20122	Pediatirc CO2 Sampling Nasal Cannula with O2, 2.5m,20pcs/box	
		CBC60122	Infant/Neonatal CO2 Sampling Nasal Cannula with O2, 2.5m,20pcs/box	
		CBC10142	Adult CO2 Sampling Nasal Cannula with O2,with Dryer, 2.5m,20pcs/box	
		CBC20142	Pediatirc CO2 Sampling Nasal Cannula with O2,with Dryer, 2.5m,20pcs/box	
		CBC60142	Infant/Neonatal CO2 Sampling Nasal Cannula with O2,with Dryer, 2.5m,20pcs/box	
		CBD10122	Adult CO <sub>2</sub> Sampling Nasal/Oral Cannula with O2, 2.5m,20pcs/box	
		CBD20121	Pediatric CO2 Sampling Nasal/Oral Cannula with O2, 2m,20pcs/box	
		CBD60121	Infant/Neonatal CO2 Sampling Nasal Cannula with O2, 2.0m,20pcs/box	
		CBD10142	Adult CO2 Sampling Nasal/Oral Cannula with O2,with Dryer, 2.5m,20pcs/box	
		CBD20141	Pediatric CO2 Sampling Nasal/Oral Cannula with O2,with Dryer, 2m,20pcs/box	
		CBD60141	Infant/Neonatal CO2 Sampling Nasal/Oral Cannula with O2,with Dryer, 2m,20pcs/box	





OEM Manufacturer & Models	Ref Picture	OEM #	Order Code	Time	Descriptions	Pice
<b>Compatible Micro-stream CO2 Accessories (Oridion)</b>						
For Micro-stream CO2 Module Monitors (such as Mindray, Philips)		XS04620 0010-10-42560	CBF50511	6h	Adult/Pediatric L Adapter, 2m,15pcs/box	
		XS04624 0010-10-42561	CBF50532	72h	Adult/Pediatric L Adapter with Dryer, 2.5m,15pcs/box	
		Mindray OEM # 0010-10-42560	CBE50512	6h	Adult/Pediatric T Adapter, 2.5m,15pcs/box	
		Mindray OEM # 0010-10-42561 Philips OEM #:M1921A	CBE50532	72h	Adult/Pediatric T Adapter with Dryer, 2.5m,15pcs/box	
			CBE60512	6h	Infant/Neonatal T Adapter, 2.5m,15pcs/box	
		Mindray OEM# 0010-10-42562	CBE60532	72h	Infant/Neonatal T Adapter with Dryer, 2.5m,15pcs/box	
			CBG00512	6h	Adult/Pediatric, 2.5m,25pcs/box	
			CBG00532	72h	Adult/Pediatric with Dryer, 2.5m,25pcs/box	
		Mindray OEM #:0010-10-42563 Philips OEM #:M4686A	CBB10512	6h	Adult CO2 Sampling Nasal Cannula, 2.5m,25pcs/box	
		Mindray OEM #:0010-10-42578 Philips OEM #:M4687A	CBB20512	6h	Pediatric CO2 Sampling Nasal Cannula, 2.5m,25pcs/box	
			CBB60512	6h	Infant/Neonatal CO2 Sampling Nasal Cannula, 2.5m,25pcs/box	
		Mindray OEM #:0010-10-42572 Philips OEM #:M4689A	CBB10532	72h	Adult CO2 Sampling Nasal Cannula with Dryer, 2.5m,25pcs/box	
		Mindray OEM #:0010-10-42574 Philips OEM	CBB20532	72h	Pediatric CO2 Sampling Nasal Cannula with Dryer, 2.5m,25pcs/box	
			CBB60532	72h	Infant/Neonatal CO2 Sampling Nasal Cannula, 2.5m,25pcs/box	
		Mindray OEM #:0010-10-42566	CBD10512	6h	Adult CO2 Sampling Nasal/Oral Cannula, 2.5m,25pcs/box	
		Mindray OEM #:0010-10-42567	CBD20512	6h	Pediatric CO2 Sampling Nasal/Oral Cannula, 2.5m,25pcs/box	
			CBD60512	6h	Infant/Neonatal CO2 Sampling Nasal/Oral Cannula, 2.5m,25pcs/box	

OEM Manufacturer & Models	Ref Picture	OEM #	Order Code	Time	Descriptions	Pice	
For Micro-stream CO2 Module Monitors (such as Mindray, Philips)			CBD10532	72h	Adult CO2 Sampling Nasal/Oral Cannula with Dryer, 2.5m,25pcs/box		
			CBD20532	72h	Pediatirc CO2 Sampling Nasal/Oral Cannula with Dryer, 2.5m,25pcs/box		
			CBD60532	72h	Infant/Neonatal CO2 Sampling Nasal/Oral Cannula with Dryer, 2.5m,25pcs/box		
				CBC10522	6h	Adult CO2 Sampling Nasal Cannula with O2, 2.5m,20pcs/box	
				CBC20522	6h	Pediatirc CO2 Sampling Nasal Cannula with O2, 2.5m,20pcs/box	
				CBC60522	6h	Infant/Neonatal CO2 Sampling Nasal Cannula with O2, 2.5m,20pcs/box	
		Mindray OEM #:0010-10-42575 Philips OEM #:M4680A		CBC10542	72h	Adult CO2 Sampling Nasal Cannula with O2 with Dryer, 2.5m,20pcs/box	
		Mindray OEM #:0010-10-42576 Phipps OEM#:M4681A		CBC20542	72h	Pediatirc CO2 Sampling Nasal Cannula with O2 with Dryer, 2.5m,20pcs/box	
				CBC60542	72h	Infant/Neonatal CO2 Sampling Nasal Cannula with O2 with Dryer, 2.5m,20pcs/box	
		Mindray OEM #: 0010-10-42568 Philips OEM #:M2522A		CBD10522	6h	Adult CO2 Sampling Nasal/Oral Cannula with O2, 2.5m,20pcs/box	
		009822 0010-10-42569 Philips OEM #:M2520A		CBD20521	6h	Pediatric CO2 Sampling Nasal/Oral Cannula with O2, 2m,20pcs/box	
				CBD60521	6h	Infant/Neonatal CO2 Sampling Nasal Cannula with O2, 2m,20pcs/box	
				CBD10542	72h	Adult CO2 Sampling Nasal/Oral Cannula with O2,with Dryer, 2.5m,20pcs/box	
		008180 0010-10-42575 Philips OEM #: 989803179121		CBD20541	72h	Pediatric CO2 Sampling Nasal/Oral Cannula with O2,with Dryer, 2m,20pcs/box	
				CBD60541	72h	Infant/Neonatal CO2 Sampling Nasal/Oral Cannula with O2,with Dryer, 2m,20pcs/box	

OEM Manufacturer & Models	Ref Picture	OEM #	Order Code	Time	Descriptions	Pice
<b>Compatible Micro-stream CO2 Accessories (Masimo)</b>						
For Micro-stream CO2 Module Monitors (Masimo)		3814	CBE50311	12h	Adult/Pediatric T Adapter, 2.0m,15pcs/box	
		4620	CBE50314	12h	Adult/Pediatric T Adapter, 4.0m,15pcs/box	
			CBE60311	12h	Infant/Neonatal T Adapter, 2.0m,15pcs/box	
		3827	CBE50331	120h	Adult/Pediatric T Adapter with Dryer, 2.0m,15pcs/box	
		3828	CBE50333	120h	Adult/Pediatric T Adapter with Dryer , 3.0m,15pcs/box	
			4367	CBE60331	120h	Infant/Neonatal T Adapter with Dryer, 2.0m,15pcs/box
				CBG00312	12h	Adult/Pediatric, 2.5m,25pcs/box
				CBG00332	120h	Adult/Pediatric with Dryer, 2.5m,25pcs/box
		3817	CBB10312	12h	Adult CO2 Sampling Nasal Cannula, 2.5m,25pcs/box	
		3818	CBB20311	12h	Pediatric CO2 Sampling Nasal Cannula, 2m,25pcs/box	
		3819	CBB60311	12h	Infant CO2 Sampling Nasal Cannula, 2m,25pcs/box	
		3830	CBB10332	120h	Adult CO2 Sampling Nasal Cannula with Dryer, 2.5m,25pcs/box	
			CBB20331	120h	Pediatric CO2 Sampling Nasal Cannula with Dryer, 2m,25pcs/box	
		3832	CBB60331	120h	Infant CO2 Sampling Nasal Cannula,with Dryer, 2m,25pcs/box	
			CBD10312	12h	Adult CO2 Sampling Nasal/Oral Cannula, 2.5m,25pcs/box	
			CBD20311	12h	Pediatric CO2 Sampling Nasal/Oral Cannula, 2m,25pcs/box	
			CBD60311	12h	Infant/Neonatal CO2 Sampling Nasal/Oral Cannula, 2m,25pcs/box	
		3822	CBD10332	120h	Adult CO2 Sampling Nasal/Oral Cannula with Dryer, 2.5m,25pcs/box	
		4626	CBD10334	120h	Adult CO2 Sampling Nasal/Oral Cannula with Dryer, 4m,25pcs/box	
		3823	CBD20331	120h	Pediatric CO2 Sampling Nasal/Oral Cannula with Dryer, 2m,25pcs/box	
			CBD60331	120h	Infant/Neonatal CO2 Sampling Nasal/Oral Cannula with Dryer, 2m,25pcs/box	





OEM Manufacturer & Models	Ref Picture	OEM #	Order Code	Time	Descriptions	Pice
For Micro-stream CO2 Module Monitors (Masimo)		3820	CBC10321	12h	Adult CO2 Sampling Nasal Cannula with O2, 2m,20pcs/box	
		4624	CBC10324	12h	Adult CO2 Sampling Nasal Cannula with O2, 4m,20pcs/box	
		3821	CBC20321	12h	Pediatric CO2 Sampling Nasal Cannula with O2, 2m,20pcs/box	
			CBC60321	12h	Infant/Neonatal CO2 Sampling Nasal Cannula with O2, 2m,20pcs/box	
		3833	CBC10341	120h	Adult CO2 Sampling Nasal Cannula with O2 with Dryer, 2m,20pcs/box	
		3834	CBC20341	120h	Pediatric CO2 Sampling Nasal Cannula with O2 with Dryer, 2m,20pcs/box	
			CBC60341	120h	Infant/Neonatal CO2 Sampling Nasal Cannula with O2 with Dryer, 2m,20pcs/box	
		3824	CBD10322	12h	Adult CO2 Sampling Nasal/Oral Cannula with O2, 2.5m,20pcs/box	
		4628	CBD10324	12h	Adult CO2 Sampling Nasal/Oral Cannula with O2, 4m,20pcs/box	
		3825	CBD20321	12h	Pediatric CO2 Sampling Nasal/Oral Cannula with O2, 2m,20pcs/box	
		4629	CBD20324	12h	Pediatric CO2 Sampling Nasal/Oral Cannula with O2, 4m,20pcs/box	
			CBD60321	12h	Infant/Neonatal CO2 Sampling Nasal/Oral Cannula with O2, 2m,20pcs/box	
		3837	CBD10341	120h	Adult CO2 Sampling Nasal/Oral Cannula with O2 with Dryer, 2m, 20pcs/box	
		3838	CBD20341	120h	Pediatric CO2 Sampling Nasal/Oral Cannula with O2 with Dryer, 2m,20pcs/box	
			CBD60341	120h	Infant/Neonatal CO2 Sampling Nasal/Oral Cannula with O2 with Dryer, 2m,20pcs/box	

OEM Manufacturer & Models	Ref Picture	OEM #	Order Code	Time	Descriptions	Pice
<b>Compatible LOFLO CO2 Accessories (Philips)</b>						
For LOFLO CO2 Module Monitors (Philips)		M2768A	CBE50411	12h	Adult/Pediatric T Adapter, 2m,15pcs/box	
		M2768A	CBE50414	12h	Adult/Pediatric T Adapter, 4m,15pcs/box	
		989803144531	CBE60411	12h	Infant/Neonatal T Adapter, 2m,15pcs/box	
		M2772A	CBE50431	120h	Adult/Pediatric T Adapter with Dryer, 2m,15pcs/box	
		M2772A	CBE50432	120h	Adult/Pediatric T Adapter with Dryer, 2.5m,15pcs/box	
		M2772A	CBE50434	120h	Adult/Pediatric T Adapter with Dryer, 4m,15pcs/box	
		M2773A	CBE60431	120h	Infant/Neonatal T Adapter with Dryer, 2m,15pcs/box	
		M2776A	CBG00412	12h	Adult/Pediatric, 2.5m,25pcs/box	
		M2777A	CBG00432	120h	Adult/Pediatric with Dryer, 2.5m,25pcs/box	
		M2744A	CBB10412	12h	Adult CO2 Sampling Nasal Cannula, 2.5m,25pcs/box	
		M2745A	CBB20411	12h	Pediatric CO2 Sampling Nasal Cannula, 2m,25pcs/box	
		M2746A	CBB30411	12h	Infant CO2 Sampling Nasal Cannula, 2.0m,25pcs/box	
			CBB10432	120h	Adult CO2 Sampling Nasal Cannula with O2 with Dryer, 2.5m,25pcs/box	
			CBB20431	120h	Pediatric CO2 Sampling Nasal Cannula with O2 with Dryer, 2.0m,25pcs/box	
			CBB30431	120h	Infant CO2 Sampling Nasal Cannula with Dryer, 2.0m,25pcs/box	
		M2756A	CBD10412	12h	Adult CO2 Sampling Nasal/Oral Cannula, 2.5m,25pcs/box	
		M2756A	CBD10414	12h	Adult CO2 Sampling Nasal/Oral Cannula, 4m,25pcs/box	
		M2757A	CBD20411	12h	Pediatric CO2 Sampling Nasal/Oral Cannula, 2m,25pcs/box	
			CBD30411	12h	Infant CO2 Sampling Nasal/Oral Cannula, 2m,25pcs/box	

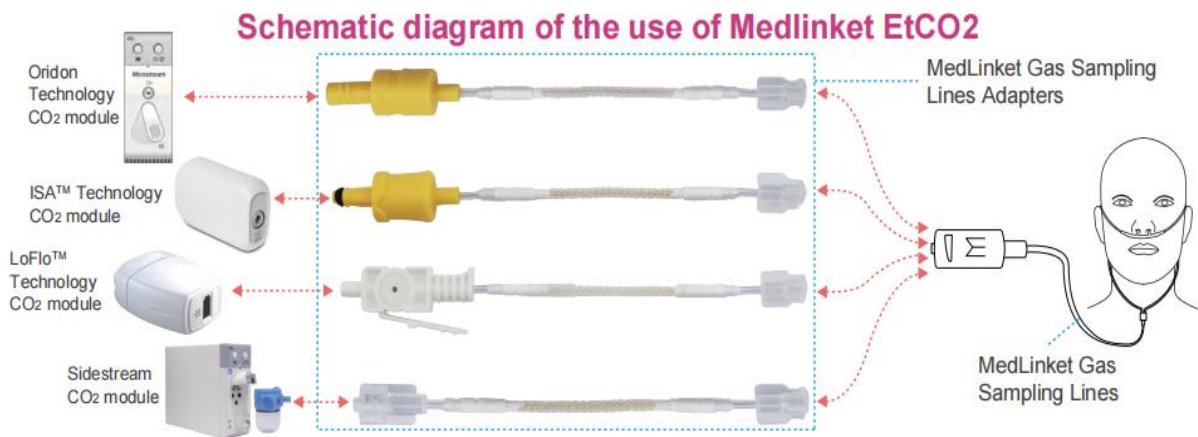



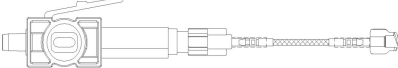



OEM Manufacturer & Models	Ref Picture	OEM #	Order Code	Time	Descriptions	Pice
For LOFLO CO2 Module Monitors (Philips)			CBD10432	120h	Adult CO2 Sampling Nasal/Oral Cannula with Dryer, 2.5m,25pcs/box	
			CBD20431	120h	Pediatric CO2 Sampling Nasal/Oral Cannula with Dryer, 2m,25pcs/box	
			CBD30431	120h	Infant CO2 Sampling Nasal/Oral Cannula with Dryer, 2m,25pcs/box	
		M2750A	CBC10421	12h	Adult CO2 Sampling Nasal Cannula with O2, 2m,20pcs/box	
		M2750A	CBC10424	12h	Adult CO2 Sampling Nasal Cannula with O2, 4m,20pcs/box	
		M2751A	CBC20421	12h	Pediatric CO2 Sampling Nasal Cannula with O2, 2m,20pcs/box	
			CBC30421	12h	Infant CO2 Sampling Nasal Cannula with O2, 2m,20pcs/box	
			CBC10441	120h	Adult CO2 Sampling Nasal Cannula with O2 with Dryer, 2m,20pcs/box	
			CBC20441	120h	Pediatric CO2 Sampling Nasal Cannula with O2 with Dryer, 2m,20pcs/box	
			CBC30441	120h	Infant CO2 Sampling Nasal Cannula with O2 with Dryer, 2m,20pcs/box	
		M2760A	CBD10421	12h	Adult CO2 Sampling Nasal/Oral Cannula with O2, 2m,20pcs/box	
		M2760A	CBD10424	12h	Adult CO2 Sampling Nasal/Oral Cannula with O2, 4m,20pcs/box	
		M2761A	CBD20421	12h	Pediatric CO2 Sampling Nasal/Oral Cannula with O2, 2m,20pcs/box	
			CBD20424	12h	Pediatric CO2 Sampling Nasal/Oral Cannula with O2, 4m,20pcs/box	
			CBD30421	12h	Infant CO2 Sampling Nasal/Oral Cannula with O2, 2m,20pcs/box	
			CBD10441	120h	Adult CO2 Sampling Nasal/Oral Cannula with O2 with Dryer, 2m,20pcs/box	
			CBD20441	120h	Pediatric CO2 Sampling Nasal/Oral Cannula with O2 with Dryer, 2m,20pcs/box	
			CBD30441	120h	Infant CO2 Sampling Nasal/Oral Cannula with O2 with Dryer, 2m,20pcs/box	

**Schematic diagram of the use of Medlinket EtCO2**





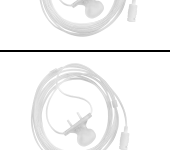













OEM Manufacturer & Models	Ref Picture	Order Code	Descriptions	Tice
<b>MedLinket Gas Sampling Lines Adapters</b>				
Medlinket Compatible Oridion Technology Monitors		CBJ00530	Adult/Pediatirc/Infant/Neonatal Single patient use with dryer, 0.16m,25pcs/box	Half a year
Medlinket Compatible Oridion Technology Monitors		CBJ00330	Adult/Pediatirc/Infant/Neonatal Single patient use with dryer, 0.16m,25pcs/box	Half a year
Medlinket Compatible Luer Joints Technology Monitors		CBJ00130	Adult/Pediatirc/Infant/Neonatal Single patient use with dryer, 0.16m,25pcs/box	Half a year
Medlinket Compatible Respiration Technology Monitors		CBJ00730	Adult/Pediatirc/Infant/Neonatal Single patient use with dryer, 0.16m,25pcs/box	Half a year
Medlinket Compatible Respiration Technology Monitors		CBJ00430	Adult/Pediatirc/Infant/Neonatal Single patient use with dryer, 0.16m,25pcs/box	Half a year

### MedLinket Gas Sampling Lines Adapters

OEM Manufacturer & Models	Ref Picture	Order Code	Descriptions	Tice
For Side-stream CO2 Module Monitors		CBF50612	Adult/Pediatirc L Adapter, 2.5m,15pcs/box	24h
		DBE50612	Adult/Pediatirc T Adapter, 2.5m,15pcs/box	24h
		CBE60612	Infant/Neonatal T Adapter, 2.5m,15pcs/box	24h
		CBG00612	Adult/Pediatirc/Infant/Neonatal Single patient use CO2 Sampling line, 2.5m,25pcs/box	24h
		CBB10612	Adult Single patient use CO2 Sampling Nasal Cannula, 2.5m,25pcs/box	24h
		CBB20612	Pediatirc Single patient use CO2 Sampling Nasal Cannula, 2.5m,25pcs/box	24h
		CBB60612	Infant/Neonatal Single patient use CO2 Sampling Nasal Cannula, 2.5m,25pcs/box	24h
		CBD10612	Adult Single patient use CO2 Sampling Nasal/Oral Cannula, 2.5m,25pcs/box	24h
		CBD20612	Pediatirc Single patient use CO2 Sampling Nasal/Oral Cannula, 2.5m,25pcs/box	24h
		CBD60612	Infant/Neonatal Single patient use CO2 Sampling Nasal/Oral Cannula, 2.5m,25pcs/box	24h

### MedLinket Gas Sampling Lines Adapters

OEM Manufacturer & Models	Ref Picture	Order Code	Descriptions	Tice
For Side-stream CO2 Module Monitors		CBB10622	Adult Single patient use CO2 Sampling Nasal Cannula with O2, 2.5m,20pcs/box	24h
		CBB20622	Pediatirc Single patient use CO2 Sampling Nasal Cannula with O2, 2.5m,20pcs/box	24h
		CBB60622	Infant/Neonatal Single patient use CO2 Sampling Nasal Cannula with O2, 2.5m,20pcs/box	24h
		CBD10622	Adult Single patient use CO2 Sampling Nasal/Oral Cannula with O2, 2.5m,20pcs/box	24h
		CBD20622	Pediatirc Single patient use CO2 Sampling Nasal/Oral Cannula with O2, 2.5m,20pcs/box	24h
		CBD60622	Infant/Neonatal Single patient use CO2 Sampling Nasal/Oral Cannula with O2, 2.5m,20pcs/box	24h

OEM Manufacturer & Models	Ref Picture	Connector Picture	Order Code	OEM #	Descriptions	Pice
<b>EtCO2 Sidestream Module (External)</b>						
Respironics			CM20-001	1022054	8pin,Sidestream EtCOz Sensor,0.65m, 50pcs/box	X0
Masimo			CM20-002	(MS-ISA AX+) 800401 (MS-ISA OR+)	9pin,Sidestream EtCOz Sensor,0.6m, 50pcs/box	X0
Nihon Kohden			CM20-006		15pin,Sidestream EtCO2 Sensor,0.65m 50pcs/box	X0
ZOLL (E/R Series)			CM20-003	8000-0367	8pin,Sidestream EtCO2 Sensor,0.65m 50pcs/box	X0
Philips			CM20-004	M2741A 989803144 591	8pin,Sidestream EtCO2 Sensor,0.65m, 50pcs/box	X0
Mindray (China)			CM20-005	115-030779-00	8pin,Sidestream EtCO2 Sensor,0.65m 50pcs/box	X0
			CA20-003		Water trap, 50pcs/box	
			CA20-098		Water trap for gas sampling tube, 20pcs/box	
<b>EtCO2 Adapter Cable</b>						
Compatible Comen		Device Side: Comen C60 Sensor Side: Respironics EtCO2 Sensor	CM10-007		0.9m,12pin to 8pin Cable Material:TPU	D3
Compatible Biolight		Device Side: Biolight Sensor Side: Respironics EtCO2 Sensor	CM10-008		0.9m,6pin to 8pin Cable Material:TPU	D3
Compatible Mindray		Device Side: MR Beniview T5-T8 Sensor Side: Respironics EtCO2 Sensor	CM10-006		0.45m,8pin to 8pin Cable Material:TPU	D3
Compatible Comen		Comen 12pin-Masimo ETCO2 Adaptor Cable	CM10-010		1m,12pin to DB9F Cable Material:TPU	D3
Compatible Philips		Device Side: Philips MP50 Sensor Side: Respironics EtCO2 Sensor	CM10-012		8pin to 8pin,0.45m	D3
Compatible NORTHERN Taurus(LEMO-Masimo)		Device Side: NORTHERN Taurus Sensor Side: Masimo EtCO2 Sensor	CM10-022		8pin to DB9F,0.2m Used with Masimo EtCO2 Sensor	D3



## MICRO CAPNOMETER

Tiny Portable Ready-to-use Capnometer

Airway adapter  
Adult/pediatric airway adapters  
and infant/neonatal airway  
adapters

EtCO2 quantity  
Quantitative EtCO2  
updated with every breath

Carbon dioxide  
partial pressure  
map



Power button

Power display

Breath rate  
Respiratory rate is displayed after two  
breaths and updated with each breath

### Optional accessories



BZ1673A  
CA60 carrying case



DC-CA-007  
CA60 data line



DC-CA-008  
Mouthpiece



CA10-001  
Adult/Child adapter



CA10-002  
Infant/Neonatal air adapter

### Compatible with mainstream monitoring brand adapter



CM10-013  
Compatible USA ZOLL



CM10-014  
Compatible China ZOLL



CM10-015  
Compatible Nihon Kohden



CM10-016  
Compatible Philips



CM10-017  
Compatible Masimo









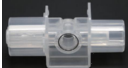





CM10-018  
Compatible

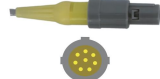

CM10-019  
Compatible

Ref Picture	OEM #	Order Code	Descriptions	Pice
<b>Main-stream CO2 Accessories</b>				
	Philips OEM #M2533A Mindray OEM#: 0010-10-42671	CAD101	Adul/Pediatric Single patient use airway Adapter, 25pcs/box	
	Philips OEM#: M2516 M2536A Mindray OEM#:0010-10-42664	CAD201	Infant/Neonatal Single patient use airway Adapter, 25pcs/box	

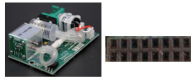
OEM Manufacturer & Models	Ref Picture	OEM #	Order Code	Descriptions	Pice
<b>EtCO2 Mainstream Module</b>					
Respironics			CM10-001	1015928	X0
Masimo			CM10-002	200601 (IRMAAX+)	X0
Nihon Kohden			CM10-020		X0
ZOLL (E/R Series)			CM10-003	8000-0312	X0
Philips			CM10-004	M2501A 989803142651	X0
Mindray (China)			CM10-005	6800-30-50760	X0
<b>EtCO2 Sidestream Module (Internal)</b>					
Respironics			CM30-001	5pin, Internal Sidestream	/
			CM30-002	16pin, Internal Sidestream	/



## Temperature Probes & Adapters

Temperature is one of the five basic vital signs standards in a critical care setting. Continuously monitoring temperature provides important insight into patient health and can help caregivers detect changes in condition as an early indicator of infection. Both our single-use and autoclavable reusable probes are designed for measuring temperature at a variety of sites, such as Foley catheter, esophageal and rectal temperature probes. They are simple to use, support standardization of probes across the hospital and help enhance efficiency and quality of care.



### Instrument Connector

For Monitor	For Infant Incubator, Warmer
0054	2515
0277	2534
0015	1211
2162	0462
0266	1594
1913	2083
0277	0053
0277	1450
2380	0520
0742	

### Yoke Type

- G: Rectangle 2P yoke
- H: 3.5 stereo Jack yoke
- J: DC5.5x2.5 Jack
- T: Dual Female 6.35 mm Jack Yoke

### Disposable Temp. Probe Connector

- Rectangle 2p plug
- 3.5 Mono plug
- DC 2.5 plug
- 6.35 Mono plug

### Probe Type & Code

- A: Reusable skin-surface probes for adult
- B: Reusable esophageal/rectal probe
- C: Reusable skin-surface probes for Pediatric
- D: Reusable esophageal/rectal probe for Pediatric
- N: Reusable skin surface probes for Neonate
- E: Disposable Skin-surface Probes
- F: Disposable Esophageal/Rectal Probes
- Disposable ear canal probes
- Foley Catheter Temperature Probes

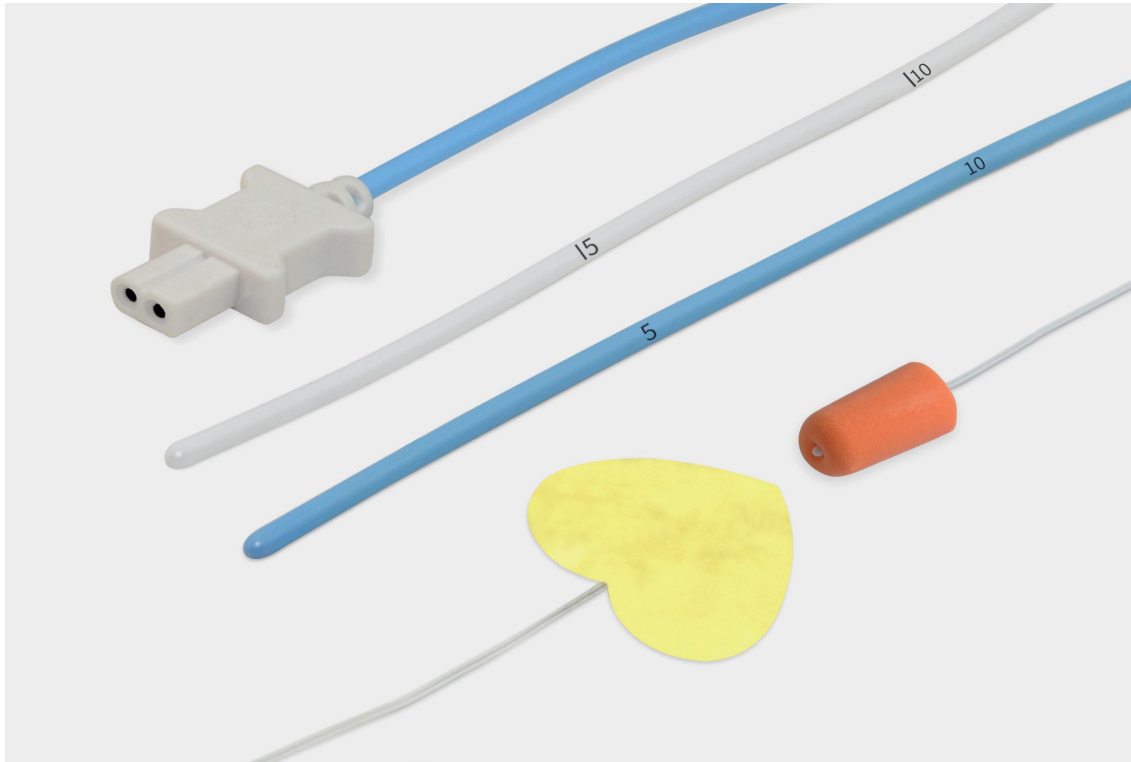

# 1 Disposable Temperature Probes

## Code Rule Description

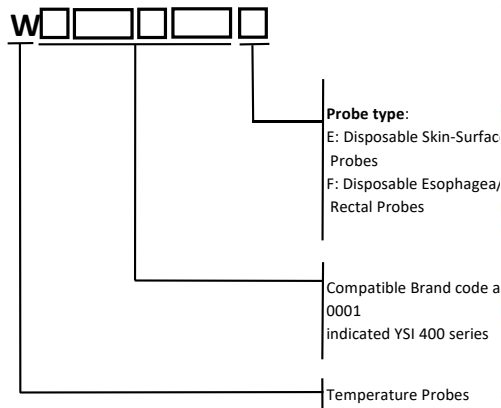

## Probe code

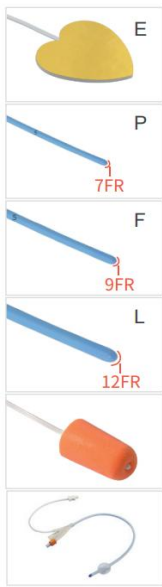

## Product Features

1. Single patient use, prevent cross infection.
2. The accuracy of the thermistor is  $\pm 0.1^{\circ}\text{C}$  from  $25^{\circ}\text{C}$  to  $45^{\circ}\text{C}$ .
3. Electromagnetic compatibility.
4. Biocompatibility passed.
5. The reflector can effectively insulate ambient temperature and radiant light (Skin-surface).
6. The medical blue PVC tube provides atraumatic insertion. Leakage current of the temperature probe (thermistor and PVC tube) is well within clinically accepted non-hazardous levels (Esophageal/Rectal one).

Disposable Skin-surface Probes













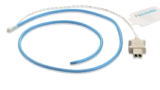

Disposable Esophageal/Rectal Probes















Disposable Esophageal/Rectal Probes













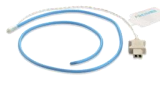

Disposable Esophageal/Rectal Probes















Disposable Ear Canal Probes canal probes

Foley Catheter Temperature Probes

OEM Manufacturer & Models	Instrument Connector	Probe Type	OEM #	Order Code	Dimension	Descriptions	Price
<b>Compatible YSI 400</b>							
Datex Ohmeda Philips Draeger Edan GE Marquette MEK Medtronic Mindray > Datascope Nihon Kohden Spacelabs Welch Allyn YSI 400 Series			8001642	W0001E	28.8*30mm	32in.(0.8m),Adult/Pediatric/Infant,Skin-surface Probes 24pcs/pk,25°C, 2.252KΩ	
			4499	W0028E	φ30mm	32in.(0.8m),Adult/Pediatric/Infant,Skin-surface Probes 24pcs/pk,25°C, 2.252KΩ	
			4499	W0001Q	10*10mm	32in.(0.8m),Infant,Skin-surface,24pcs/pk,25°C, 2.252KΩ	
			8001644	W0001P	7FR	19in.(0.48m),Rectal/Esophageal 24pcs/pk,25°C, 2.252KΩ	
				W0001F	9FR		
				W0001L	12FR		
			8001644	W0099P	7FR	24in.(0.6m),Rectal/Esophageal 24pcs/pk, 25°C,2.252KΩ	
				W0099F	9FR		
				W0099L	12FR		
			8001644	W0104P	7FR	24in.(0.6m),Rectal/Esophageal 24pcs/pk,25°C, 2.252KΩ	
W0104F	9FR						
W0104L	12FR						
		W0101F-A		32in.(0.8m),Ear Canal24pcs/pk, 25°C,2.252KΩ			
		W0101F-P		32in.(0.8m), Ear Canal Probe 24pcs/pk, Pediatric, 25°C,2.252KΩ			
		W0109F		32in.(0.8m), Esophageal/Rectal 24pcs/pk, Adult 25°C,2.252KΩ			
<b>Compatible YSI Series</b>							
YSI 400				W0103E	28.8*30mm	32in.(0.8m), 6.3mm mono plug Skin-surface Probes 24pcs/pk,Adult/ Pediatric/Infant, 25°C, 2.252KΩ	
<b>Compatible YSI 10K Series</b>							
Suitable for China OEM patient monitor: Tianrong:TR900D/E; Anke: ASC553A3, ASC553;Comen: star 8000A/B/C, star 5000, 5000B/C				W0004E	28.8*30mm	32in.(0.8m),Skin-surface Probes 24pcs/pk,25°C,10KΩ Adult/Pediatric/Infant	
				W0004P	7FR	19in.(0.6m), Rectal/Esophageal 24pcs/pk,25°C,10KΩ	
				W0004F	9FR		
			W0004L	12FR			

OEM Manufacturer & Models	Instrument Connector	Probe Type	OEM #	Order Code	Dimension	Descriptions	Price
<b>Compatible Mindray (China)</b>							
PM6800 Series			0011-30-37391	W0013E	28.8*30mm	Skin-surface Probes 24pcs/pk, 25°C, 2.252KΩ	
BENEVISION/T1/T5/T8 IMEC series IPM Series/9800					W0013F	9FR	19in. (0.48m), Esophageal/Rectal Probes 24pcs/pk, Adult/ Pediatric, 25°C, 2.252KΩ
<b>Compatible Philips</b>							
All Philips temperature monitors that accept two-prong plugs			21091A	W0003E	28.8*30mm	32in.(0.8m),Skin-surface Probes 24pcs/pk,25°C, 2.252KΩ	
			21090A	W0003P	7FR	19in.(0.48m),Rectal/Esophageal 24pcs/pk,25°C, 2.252KΩ	
				W0003F	9FR		
				W0003L	12FR		
<b>Compatible COMEN</b>							
NC series (NC3/5/8/10/12/19) STARseries (STAR5000A/B/C/D/E/F/H) STAR8000 (STAR8000A/B/C/D/E/F/H) C series (C20/30/50/60/70/80/86/90/100)				W0108F	9FR	24in. (0.6m), Esophageal/RectalProbes Adult/Pediatric, 24pcs/pk, 25°C, 10KΩ	
<b>Compatible Med-linklet</b>							
AM-807-C AM-807B AM-807B-C				W0024E	28.8*30mm	32in. (0.8m), Skin-surface Probes 24pcs/pk,Adult/Pediatric/Infant/Neonatal 25°C, 2.252KΩ	
				W0114E	28.8*30mm	32in. (0.8m), Skin-surface Probes 24pcs/pk,Adult/Pediatric/Infant/Neonatal 25°C, 2.252KΩ	
AM-807 AM-808				W0024F	9FR	19in. (0.48m), Esophageal/Rectal Probes 24pcs/pk, Adult/ Pediatric, 25°C, 2.252KΩ	

OEM Manufacturer & Models	Instrument Connector	Probe Type	OEM #	Order Code	Dimension	Descriptions	Pice
<b>Compatible YSI 400</b>							
Datex Ohmeda Philips Draeger Edan GE Marquette MEK Medtronic Mindray > Datascope Nihon Kohden Spacelabs Welch Allyn YSI 400 Series			8001642	W0001ES	28.8*30mm	Sterilized, 32in.(0.8m),Adult/Pediatric/Infant,Skin-surface Probes 24pcs/pk,25°C, 2.252KΩ	
			4499	W0028ES	φ30mm	Sterilized, 32in.(0.8m),Adult/Pediatric/Infant,Skin-surface Probes 24pcs/pk,25°C, 2.252KΩ	
			4499	W0001QS		Sterilized, 32in.(0.8m),Infant,Skin-surface,24pcs/pk,25°C,2.252 KΩ	
			8001644	W0001PS	7FR	Sterilized, 19in.(0.48m),Rectal/Esophageal 24pcs/pk,25°C, 2.252KΩ	
				W0001FS	9FR		
				W0001LS	12FR		
			8001644	W0099PS	7FR	Sterilized, 24in.(0.6m),Rectal/Esophageal 24pcs/pk, 25°C,2.252KΩ	
				W0099FS	9FR		
				W0099LS	12FR		
			8001644	W0104PS	7FR	Sterilized, 24in.(0.6m),Rectal/Esophageal 24pcs/pk,25°C, 2.252KΩ	
W0104FS	9FR						
W0104LS	12FR						
		W0101FS-A		Sterilized, 32in.(0.8m),Ear Canal, 24pcs/pk, Adult, 25°C,2.252KΩ			
		W0101FS-P		Sterilized, 32in. (0.8m), Ear Canal Probe 24pcs/pk, Pediatric, 25°C,2.252KΩ			
		W0109FS		9FR	Sterilized, 32in. (0.8m), Esophageal/Rectal 24pcs/pk, Adult 25°C,2.252KΩ		
<b>Compatible YSI Series</b>							
YSI 400				W0103ES	28.8*30mm	32in. (0.8m), 6.3mm mono plug Skin-surface Probes 24pcs/pk,Adult/Pediatric/Infant, 25°C, 2.252KΩ	
<b>Compatible YSI 10K Series</b>							
Suitable for China OEM patient monitor: Tianrong:TR900D/E; Anke: ASC553A3, ASC553;Comen: star 8000A/B/C, star 5000, 5000B/C				W0004ES	28.8*30mm	32in.(0.8m),Skin-surface Probes 24pcs/pk,25°C,10KΩ Adult/Pediatric/Infant	
				W0004PS	7FR	19in.(0.48m), Rectal/Esophageal 24pcs/pk,25°C,10KΩ	
				W0004FS	9FR		
				W0004LS	12FR		

OEM Manufacturer & Models	Instrument Connector	Probe Type	OEM #	Order Code	Dimension	Descriptions	Pice
<b>Compatible Mindray (China)</b>							
PM6800 Series			0011-30-37391	W0013ES	28.8*30mm	Skin-surface Probes 24pcs/pk, 25°C, 2.252KΩ	
BENEVISION/T1/T5/T8 IMEC series IPM Series/9800					W0013FS	9FR	19in. (0.48m), Esophageal/Rectal Probes 24pcs/pk, Adult/ Pediatric, 25°C, 2.252KΩ
<b>Compatible Philips</b>							
All Philips temperature monitors that accept two-prong plugs			21091A	W0003ES	28.8*30mm	32in.(0.8m),Skin-surface Probes 24pcs/pk,25°C, 2.252KΩ	
			21090A	W0003PS	7FR	19in.(0.48m),Rectal/ Esophageal 24pcs/pk,25°C, 2.252KΩ	
				W0003FS	9FR		
				W0003LS	12FR		
<b>Compatible COMEN</b>							
NC series (NC3/5/8/10/12/19) STARseries (STAR5000A/B/C/D/E/F/H ) STAR8000 (STAR8000A/B/C/D/E/F/H) C series (C20/30/50/60/70/80/86/90 /100)				W0108FS	9FR	24in. (0.6m), Esophageal/RectalProbes Adult/Pediatric, 24pcs/pk, 25°C, 10KΩ	
<b>Compatible Med-Linklet</b>							
AM-807-C AM-807B AM-807B-C				W0024ES	28.8*30mm	32in. (0.8m), Skin-surface Probes 24pcs/pk,Adult/Pediatric/Inf ant /Neonatal 25°C, 2.252KΩ	
				W0114ES	28.8*30mm	32in. (0.8m), Skin-surface Probes 24pcs/pk,Adult/Pediatric/Inf ant /Neonatal 25°C, 2.252KΩ	
AM-807 AM-808				W0024FS	9FR	19in. (0.48m), Esophageal/Rectal Probes 24pcs/pk, Adult/ Pediatric, 25°C, 2.252KΩ	

Medlinket Provide Sterile Disposable Temperature Probes.

## Disposable Sterile Temperature Measuring Catheter

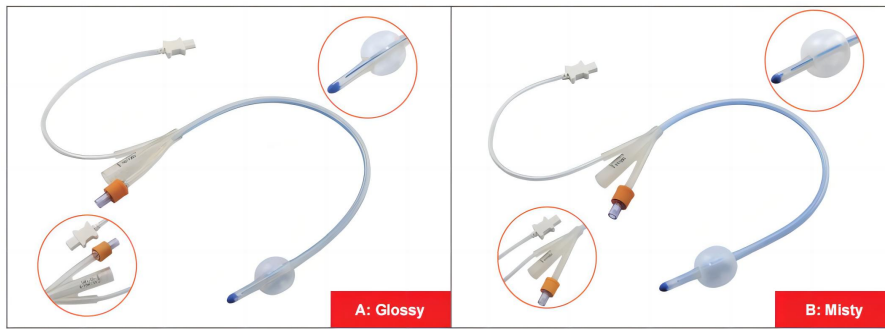

### Product Features

- Dual functions, it can not only do urinary catheterization but also monitor the patient's body temperature anytime without interruption;
- It can accurately measure the bladder temperature consistent with the intracranial body temperature, effectively reducing the intraoperative risk caused by intraoperative temperature changes;
- One-time use for a single patient to prevent cross-infection;
- The product is made of silica gel and can stay in the body for a longer time (28 days);
- The product specifications and models are complete, and there are many options for clinical use.

### Scope of Application

Used together with a monitor, it is used for one-time use during catheterization and drainage of patients, and can detect bladder temperature at the same time.

Order Code	Surface Technics	OD	Color	Balloon Volume	Length	Packing	Pice
EC0112A	Glossy	12FR,4.0±0.2	White	5-10ml	400mm	10pcs/bag, 12bag/box	
FC0114A		14FR,4.7±0.2	Green	5-15ml			
FC0116A		16FR,5.3±0.2	Orange	5-15ml			
FC0118A		18FR,6.0±0.2	Red	5-15ml			
FC0120A		20FR,6.7±0.2	Yellow	30ml			
FC0122A		22FR,7.3±0.2	Violet	30ml			
FC0124A		24FR,8.0±0.2	Blue	30ml			
FC0112B	Misty	12FR,4.0±0.2	White	5-10ml			
FC0114B		14FR,4.7±0.2	Green	5-15ml			
FC0116B		16FR,5.3±0.2	Orange	5-15ml			
FC0118B		18FR,6.0±0.2	Red	5-15ml			
FC0120B		20FR,6.7±0.2	Yellow	30ml			
FC0122B		22FR,7.3±0.2	Violet	30ml			
FC0124B		24FR,8.0±0.2	Blue	30ml			



## 2 Temperature Adapter Cables

### Type Designation

W

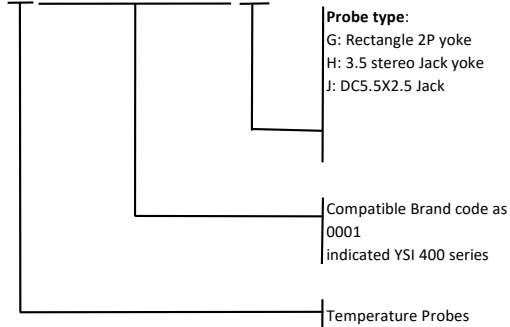

### Probe Type and Code



### Product Features

1. High performance noise ratio
2. Injection molding process, strong and durable

OEM Manufacturer & Models	Instrument Connector	YokeProbe Side	OEM #	Order Code	Length	Descriptions	Price
<b>Compatible Biolight</b>							
Biolight A series (A2/A3/A5/A6/A8), Q series (Q3/Q4/Q5/Q6/Q7)				W0113G	2.5m	Used with YSI 400 Series Disposable Probes	A0
<b>Compatible Comen (China)</b>							
STAR8000E/F/H NC 8/10/12/19 C20/30/50/60/70/90/100				W0092G	2.5m	Used with YSI 400 Series Disposable Probes	A0
<b>Compatible Creative (China)</b>							
Creative				W0005G	2.4m	Used with YSI 400 Series Disposable Probes	A0
<b>Compatible Drager</b>							
Siemens medical SC 6002XL, SC7000, SC8000, SC9000XL			5198333	W0008G	2.5m	Used with YSI 400 Series Disposable Probes	A0
<b>Compatible Edan (China)</b>							
IM series (50/60/70/80); Elite V series (V5/V5/V8); IX series(X8/X10/X12/X15)				W0116G	2.5m	Used with YSI 400 Series Disposable Probes	A0
<b>Compatible GE</b>							
Carescape B450/B650/B850, Tram 451			402015-004	W0015T	0.3m	Used with YSI 400 or 700 Series Disposable Probes	C7
PDM Module, Procure B40			2021701-001	W0015G	3.6m	Used with YSI 400 Series Disposable Probes	A0
GE-MARQUETTE				W0015M	0.5m	Used with YSI 400 Series or W0001 Series Temp. Probes	A0
<b>Compatible Mindray (China)</b>							
BeneHeart, BeneView/T1/T5/T8, Beneheart D6/DPM6/DPM7, Passport 12/8, iMEC Series, iPM Series/9800			040-001 235-00	W0013G	2.5m	Used with YSI 400 Series Disposable Probes	A0
				W0013L	5.0m		B1
			0011-30-37391, 0011-30-90444	W0013J	2.4m	Used with Female Mono Plug Series Disposable Probes	A0

OEM Manufacturer & Models	Instrument Connector	YokeProbe Side	OEM #	Order Code	Length	Descriptions	Price
<b>Compatible Philips</b>							
IntelliVue MMS X2/MP2/MX400/ MX800/, M1029A/ M3001A/A04C18				W0003G	2.5m	Used with YSI 400 Series Disposable Probes	A0
			21082A 9898031 0921	W0003H	2.4m	Used with 3.5mm Mono Plug Series Disposable Probes	A0
<b>Compatible Spacelabs</b>							
Siemens medical SC 6002XL, SC7000, SC8000, SC9000XL				W0022G	2.5m	Used with YSI 400 Series Disposable Probes	A0
			700-4000-00	W0022T	0.3m	Used with YSI 400 or 700 Series Disposable Probes	C7
<b>Compatible YSI</b>							
See YSI Temp. Probe			E9004ZS	W0001G	2.5m	Used with YSI 400 Series Disposable Probes	A6
<b>Compatible MedLinket</b>							
AM806, AM806B				S0177MD-S	0.6m	Y-adapter,USB 12P to 7P(SPO2)/ 2P(TEMP),	B0



### 3 Reusable Temperature Probes

#### Type Designation

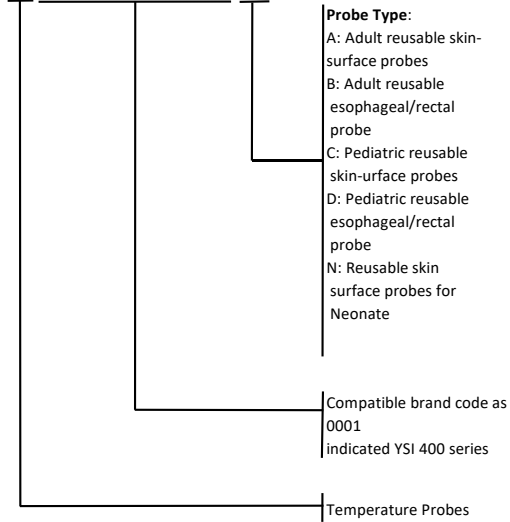







#### Probe Type and Code



#### Product Features

1. High precision:  $\pm 0.1^{\circ}\text{C}$
2. Quick response
3. High performance noise ratio
4. Fully compatible with OEM technology
5. Complete product specifications

OEM Manufacturer & Models	Instrument Connector	Probe Type	OEM #	Order Code	Resister Type	Descriptions	Price
<b>Temperature accessories for monitor</b>							
<b>Compatible Air Shields</b>							
C-550 QT, Isolette C100/2000/C450, Isolette C100 QT/C450 QT/C550, PM78				W0010A	25°C 6.867KΩ	10ft (3.0m), Adult skin	B0
				W0010B	25°C 6.867KΩ	10ft (3.0m), Adult Rectal/Esophageal	B0
<b>Compatible Artema/S&amp;W</b>							
DIASCOPE G2			T1302	W0007B	25°C 2.252KΩ	10ft (3.0m), Adult Rectal/Esophageal	B5
<b>Compatible Comen (China)</b>							
STAR 8000 series, NC series, K series, C series				W0092A	25°C 2.252KΩ	10ft (3.0m), Adult skin	B3
				W0092B	25°C 2.252KΩ	10ft (3.0m), Adult Rectal/Esophageal	B3
				W0092C	25°C 2.252KΩ	10ft (3.0m), Pediatric skin	B3
				W0092D	25°C 2.252KΩ	10ft (3.0m), Pediatric Rectal/Esophageal	B3
			040-000246-00	W0128A	25°C 10KΩ	10ft (3.0m), Adult skin	B3
			040-000385-00	W0128B	25°C 10KΩ	10ft (3.0m), Adult Rectal/Esophageal	B3
			040-000387-00	W0128C	25°C 10KΩ	10ft (3.0m), Pediatric skin	B3
			040-000386-00	W0128D	25°C 10KΩ	10ft (3.0m), Pediatric/ Neonatal Rectal/Esophageal	B3
<b>Compatible Creative (China)</b>							
PC-1000, 5000 9000, UP-6000				W0005A	25°C 10KΩ	10ft (3.0m), Adult skin	B5
<b>Compatible Biolight</b>							
Biolight A series (A2/A3/A5/A6/A8), Q series (Q3/Q4/Q5/Q6/Q7)			15-031-0005	W0113A	25°C 2.252KΩ	10ft (3.0m), Adult skin	B3
			15-031-0012	W0113B	25°C 2.252KΩ	10ft (3.0m), Adult Rectal/Esophageal	B3
				W0113C	25°C 2.252KΩ	10ft (3.0m), Pediatric skin	B3
				W0113D	25°C 2.252KΩ	10ft (3.0m), Pediatric Rectal/Esophageal	B3

OEM Manufacturer & Models	Instrument Connector	Probe Type	OEM #	Order Code	Resister Type	Descriptions	Price
<b>Temperature accessories for monitor</b>							
<b>Compatible Drager</b>							
Infinity Delta, Infinity Gamma, Infinity Kappa, Infinity Vista			5204669	W0008A	25°C 2.252KQ	10ft (3.0m),Adult skin	B5
			4329889	W0008B	25°C 2.252KQ	10ft (3.0m),Adult Rectal/Esophageal	B5
				W0008C	25°C 2.252KQ	10ft (3.0m), Pediatric skin	B7
				W0008D	25°C 2.252KQ	10ft (3.0m),Pediatric Rectal/Esophageal	B7
<b>Compatible Edan (China)</b>							
IM series (50/60/70/80); Elite V series (V5/V5/V8); IX series(X8/X10/ X12/X15)			01.15.0402 25	W0116A	25°C 10KQ	10ft (3.0m),Adult skin	C0
			01.15.0402 28	W0116B	25°C 10KQ	10ft (3.0m),Adult Rectal/Esophageal	C0
			01.15.0402 55	W0116C	25°C 10KQ	10ft (3.0m), Pediatric skin	C0
			01.15.0402 256	W0116D	25°C 10KQ	10 ft(3.0m),Pediatric Rectal/Esophageal	C0
<b>Compatible GE</b>							
GE CARESCAPE series (B450/B650/ B850), DASH series (2500/3000/4000), B20/40series, B105M/B105P/ B125M/B125P/ B155M				W0015A	25°C 2.252KQ	10ft (3.0m),Adult skin	B0
				W0015B	25°C 2.252KQ	10ft (3.0m),Adult Rectal/Esophageal	B0
				W0015C	25°C 2.252KQ	10ft (3.0m), Pediatric skin	C1
				W0015D	25°C 2.252KQ	10ft (3.0m),Pediatric Rectal/Esophageal	C1
<b>Compatible Mindray-datascope</b>							
Passport V, V-Series			040-0000 57-00	W0112A	25°C 2.252KQ	10ft (3.0m),Adult skin	C0
			040-0000 55-00	W0112B	25°C 2.252KQ	10ft (3.0m),Adult Rectal/Esophageal	C0
			040-0000 58-00	W0112C	25°C 2.252KQ	10ft (3.0m), Pediatric skin	C0
			040-0000 56-00	W0112D	25°C 2.252KQ	10ft (3.0m),Pediatric Rectal/Esophageal	C0

OEM Manufacturer & Models	Instrument Connector	Probe Type	OEM #	Order Code	Resister Type	Descriptions	Price
<b>Temperature accessories for monitor</b>							
<b>Compatible Mindray (China)</b>							
BeneVision N Series: N1/N17/N15/N12/N2 2/N19/N15/N17 ICU; BeneVision(BeneV-iew) T Series: T1/T5/T6/T8/T9; ePM Series: ePM10/12/15/10M/ 12M;iPM Series: iPM8/10/12; iMEC Series:iMEC8/10/12/5C ;uMEC Series: uMEC10/12			0011-30-37393	W0013A	25°C 2.252KQ	10ft (3.0m),Adult skin	B0
			(0011-30-37382) (0011-30-37392)	W0013B	25°C 2.252KQ	10ft (3.0m),Adult Rectal/Esophageal	B0
			0011-30-37395 (MR404B)	W0013C	25°C 2.252KQ	10ft (3.0m), Pediatric skin	C1
			0011-30-37394	W0013D	25°C 2.252KQ	10ft (3.0m),Pediatric Rectal/Esophageal	C1
<b>Compatible Philips</b>							
Philips: MP Series: MP20/30/40/50/60/70 /80/90; MX Series: MX400/450/500/550; SureSigns VM4/VM6/VM8; Goldway: CM Series: CM100/10/120/12/ 150			21078A	W0003A	25°C 2.252KQ	10ft (3.0m),Adult skin	B5
			21075A	W0003B	25°C 2.252KQ	10ft (3.0m),Adult Rectal/Esophageal	B5
				W0003C	25°C 2.252KQ	10ft (3.0m), Pediatric skin	B7
			21076A	W0003D	25°C 2.252KQ	10ft (3.0m),Pediatric Rectal/Esophageal	B7
<b>Compatible Sunray</b>							
Sunray: SRF				W0134A	25°C 2.252KQ	10ft (3.0m), Adult skin	B0
<b>Compatible Spacelabs</b>							
Spacelab: New modules 90651-08, 90496, Ultraview			20700-4000-00A	W0022A	25°C 2.252KQ	10ft (3.0m), Adult skin	B0
				W0022B	25°C 2.252KQ	10ft (3.0m), Adult Rectal/Esophageal	B0
<b>Compatible YSI 400 series</b>							
CAS Med: 750 CSI: 1100, 2200 Ohmeda: CS/3, Cardiicap I Draeger: Infinity Delta, Infinity Gamma Edan: M50, M80 Datascope: PM 7000 Nihon Kohden: Spacelabs: Welch Allyn: YSI: 400 Series Zoll			409B, 709B, 701, 85409	W0001A	25°C 2.252KQ	10ft (3.0m), Adult skin	A9
			YSI: 401 GE P/N: 9445-004	W0001B	25°C 2.252KQ	10ft (3.0m), Adult Rectal/Esophageal	A9

OEM Manufacturer & Models	Instrument Connector	Probe Type	OEM #	Order Code	Resister Type	Descriptions	Price
<b>Temperature accessories for monitor</b>							
<b>Compatible YSI 400 series</b>							
CAS Med: 750, CSI: 1100, 2200, Ohmeda: CS/3, Cardiicap I, Draeger: Infinity Delta, Infinity Gamma, Edan: M50, M80 Datascope: PM 7000 Nihon Kohden: Spacelabs:Welch Allyn: YSI: 400 Series, Zoll			YSt:427 Welch Allyn P/N:008-07 56-00	W0001C	25°C 2.252KQ	10ft (3.0m), Pediatric skin	A0
			YSI:402 GE P/N: M1024251	W0001D	25°C 2.252KQ	10ft(3.0m),Pediatric Rectal/Esophageal	A0
				W0029A	25°C 2.252KQ	10ft(3.0m),Adult skin	A9
				W0029C	25°C 2.252KQ	10ft (3.0m), Pediatric skin	A0
YSI 400 series				W0029N	25°C 2.252KQ	10ft (3.0m),Neonate 6.35mm Mono Plug	A0
YSI 400 (Need Extension)				W0001N	25°C 2.252KQ	5ft (1.5m), Neonate Skin-surface Probes	B7
<b>Compatible 10k, 25°C</b>							
Tianrong: TR900 D/E; Anke: ASC553A3, ASC553; Comen: star 8000A/B/C, star 5000, 5000B/C				W0004A	25°C 10KQ	10ft (3.0m),Adult skin	A8
				W0004B	25°C 10KQ	10ft (3.0m),Adult Rectal/Esophageal	A8
<b>Compatible 2.016K, 25°C</b>							
YSI 25°C@2.016KQ O.S.7929			Ref.092.0 59.600	W0009A	25°C 2.016KQ	10ft (3.0m),Adult skin	B0
<b>Compatible DALLAS 18B20 Probe</b>							
18B20 series				W0006A	18B20	10ft (3.0m),Adult skin	B0
				W0006B	18B20	10ft (3.0m),Adult Rectal/ Esophageal	B0
<b>Compatible Med-linket</b>							
AM-801, AM-805, AM-806, AM-806B				W0114C	25°C 2.252KQ	3.3ft(1.0m),Pediatric Rectal/Esophageal	B7
				W0001N (Need Adapters Cable S0177MD- S)	25°C 2.252KQ	5ft(1.5m), Neonate Skin-surface Probes	B7



## 4 Infant Incubators Warmer Temperature Probes

### Type Designation

W

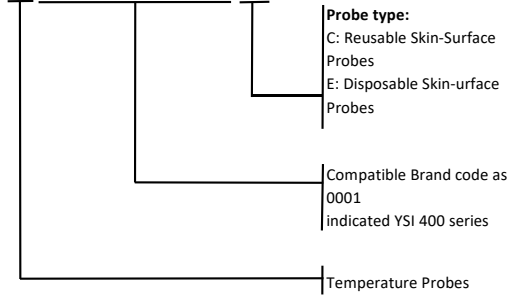

### Probe Type and Code



C

Reusable Skin-surface Probes for Pediatric

































E





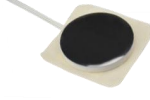







Disposable Skin-surface Probes



### Product Features

1. The accuracy of the thermister is  $\pm 0.1^{\circ}\text{C}$  from  $25^{\circ}\text{C}$  to  $45^{\circ}\text{C}$ .
2. Hydrogel stickers available, which is more friendly to babies, and biocompatibility passed.
3. Electromagnetic compatibility.
4. The reflector can effectively insulate ambient temperature and radiant light(Skin-surface).
5. Fully compatible with most of patient monitors.

OEM Manufacturer & Models	Instrument Connector	Probe Type	OEM #	Order Code	Descriptions	Pice
<b>Compatible ATOM (JAPAN)</b>						
Infant Incubator: V-2100, V-2100G, V-2200 Infant Radiant Warmer: V3200, V-3200D/V-505, V-505ST Transport Incubator: V-80, V-800, V-707/V-808, V-850			NF-024/ 60881/ 60881/ 60883	W0138C	118in.(1.5m)Reusable Skin-surface Probes 1pcs/bag	
					W0106C	60in.(3.0m)Reusable Skin-surface Probes 1pcs/bag
			NF-023/ 60884	W0111E	47in. (1.2m), disposable Skin-surface Probes 24pcs/pk	
<b>Compatible Drager Air-Shields</b>						
ISOLETTE® C2000/8000			MU12525	W0045E	47in.(1.2m), disposable Skin-surface Probes,24pcs/pk	
			MU12525	W0045ES	Sterilized, 47in.(1.2m), disposable Skin-surface Probes,24pcs/pk	
			MU12520	W0045K	26in.(0.67m) Adapter cable,5 pin to 4 pin input connection	
			MU12533	W0045C	47in.(1.2m), reusable Skin-surface Probes,1pcs/bag	
IsoletteC450 C-550 QT, Isolette C100, Isolette C100 QT, Isolette C450/QT, Isolette C550, GLOBE-TROT_x005f TER GT5400, IICS-90, PM78			MU06951	W0010C	60in.(3.0m), reusable Skin-surface Probes,1pcs/bag	
			MU06933	W0010E	47in.(1.2m), disposable Skin-surface Probes,24pcs/pk	
Incubators (BABYTHER_x005f M®)8000 WB/8004/8010/ 4200 CALEO®				W0020C	32in.(0.8m), Reusable Skin-surface Probes,1pcs/bag	
			MX11001	W0020E	32in.(1.2m), disposable Skin-surface Probes,24pcs/pk	
			MX11001	W0020ES	Sterilized, 32in. (0.8m), disposable Skin-surface Probes, 24pcs/pk	
				W0095E	63in.(1.6m), disposable Skin-surface Probes,24pcs/pk	

OEM Manufacturer & Models	Instrument Connector	Probe Type	OEM #	Order Code	Descriptions	Pice
<b>Compatible David (China)</b>						
InfantIncubator: YP-3000, YP-2008, YP-2000, YP-970, YP-930/920, 910 (The above is a new machine)			88.10.005.00	W0119C	59in.(1.5m) reusable Skin-surface Probes,1pcs/bag	
					W0119E	47in.(1.2m), disposable Skin-surface Probes,24pcs/pk
			88.09.005.00	W0120C	59in.(1.5m), reusable Skin-surface Probes,1pcs/bag	
					W0120E	47in.(1.2m), disposable Skin-surface Probes,24pcs/pk
Infant Radiant Warmer: HKN-93/93A/93B/ 93C/, HKN-2001, HKN-9010			88.10.005.00	W0119C	59in.(1.5m) reusable Skin-surface Probes,1pcs/bag	
					W0119E	47in.(1.2m), disposable Skin-surface Probes,24pcs/pk
Transport Incubator: TI-2000			88.09.005.00	W0120C	59in.(1.5m), reusable Skin-surface Probes,1pcs/bag	
					W0120E	47in.(1.2m), disposable Skin-surface Probes,24pcs/pk
<b>Compatible GE Datex-ohmeda</b>						
Giraffe series			6600-0875-700	W0026C	118in.(3.0m), reusable Skin-surface Probes,1pcs/bag	
			6600-0873-700 6600-0874-700	W0026E	118in.(3.0m), disposable Skin-surface Probes,24pcs/pk	
General Care (GC) Incubators (3000/3300/ 4000/5000), Ohio Infant Care (IC), Panda Infant Warmers			0208-0697-700 6600-0628-700	W0021C	59in.(3.0m) reusable Skin-surface Probes,1pcs/bag	
			6600-208-700 6600-0196-700	W0021E	47in.(3.0m) disposable Skin-surface Probes,24pcs/pk	

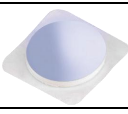
OEM Manufacturer & Models	Instrument Connector	Probe Type	OEM #	Order Code	Descriptions	Pice
<b>Compatible Zhengzhou Dison</b>						
Infant Incubator: BB-300W/300G/ 300/200W/200G/ 200/100W/100G/ 100 Infant Radiant Warmer: BN-200/100/100A				W0117C	59in.(1.5m), reusable Skin-surface Probes,1pcs/bag	
				W0117E	47in.(1.2m), disposable Skin-surface Probes,24pcs/pk	
				W0118C	59in.(1.5m), reusable Skin-surface Probes,1pcs/bag	
				W0118E	47in.(1.2m), disposable Skin-surface Probes,24pcs/pk	
<b>Compatible Julongsanyou</b>						
Infant Incubator: B-4500/4000/ 3000/2000/ 1000/800				W0123C	59in.(1.5m), reusable Skin-surface Probes,1pcs/bag	
				W0123E	47in.(1.2m), disposable Skin-surface Probes,24pcs/pk	
Infant Radiant Warmer: BNT-300/2000B/ 2000/1000				W0122C	59in.(1.5m), reusable Skin-surface Probes,1pcs/bag	
				W0122E	47in.(1.2m), disposable Skin-surface Probes,24pcs/pk	







<b>Temperature Probe Accessories</b>						
Order Code	Product Picture	Descriptions	Scope of Application/ Characteristics			Pice
BZ0109D		Heart shape 28.8*30mm, reflective radiating patch	The radiation reflection paste is used in combination with reusable and disposable temperature probe, which is fixed on human epidermis to ensure more accurate body temperature detection. Characteristic: 1) Which can effectively isolate ambient temperature and radiated light; 2) Optional hydrogel radiation reflective patches that are more friendly to infants.			
BZ0501A		Circular shape, 30mm, reflective radiating patch				
BZ0109F		Heart shape, 28.8*30mm, hydrogel reflective radiating patch				

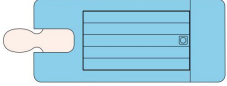
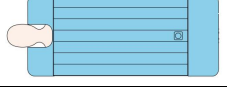

## 5 Disposable Warming Blankets

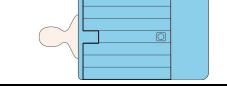
The disposable sterile warming blanket provided by Medlinket is a powered inflatable warming blanket, which meets the requirements of in-hospital anesthesia operating room sensory control, can effectively solve the phenomenon of hypothermia in surgical patients, reduce the probability of chills during the awakening period, and shorten the awakening time of patients.

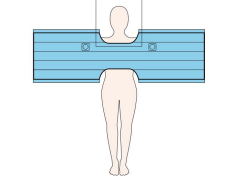
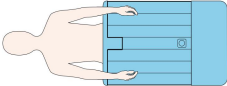
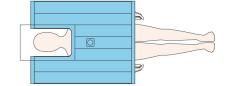
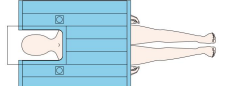

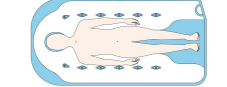
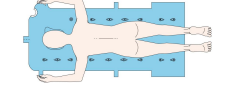

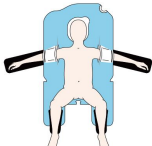
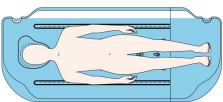
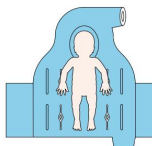
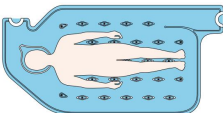
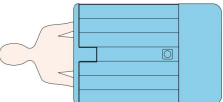
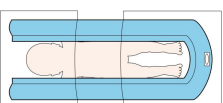
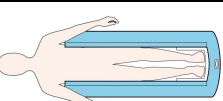
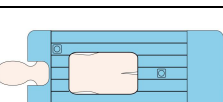
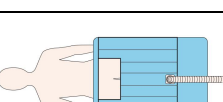
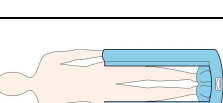
Medlinket can provide 24 types of warming blankets for different clinical needs (e.g. preoperative, intraoperative, postoperative, padding blanket), and special warming blankets according to special needs (e.g. cardiology, interventional catheter, pediatrics, amputation position, etc.) to meet all patients warming needs.

OEM Manufacturer & Models	Ref Picture	Order Code	Descriptions	Type	size	
3M Bair Hugger™, Smith Warming Instruments		HB01-110	Preoperative & Outpatient Care Blanket with Booties	Preoperative blanket series	200*110cm	
		HB01-111	Preoperative & Outpatient Care Blanket		200*110cm	
		HB02-300	Full Body	Postoperative blanket series	200*100cm	
		HB02-305	Chest Access		200*110cm	
		HB02-310	Pediatric		150*100cm	
		HB02-315	Multi-Access		200*110cm	
		HB03-522	Upper Body		Intraoperative blanket series	68*182cm
		HB03-523	XL Upper Body Blanket	75*200cm		
		HB03-525	Lower Body	127*100cm		
		HB03-540	Torso	115*100cm		
		HB03-542	Dual Port Torso	115*100cm		
		HB03-610	Full Body Surgical	200*110cm		
		HB04-545	Adult Underbody	Mat blanket series		195*100cm
		HB04-575	Spinal Underbody			195*100cm

OEM Manufacturer & Models	Ref Picture	Order Code	Descriptions	Type	size
3M Bair Hugger™, Smith Warming Instruments		HB04-585	Lithotomy Underbody	Mat blanket series	170*100cm
		HB04-635	Full Access Underbody		195*100cm
		HB05-555	Pediatric Underbody		98*75cm
		HB05-550	Large Pediatric Underbody		165*100cm
		HB05-537	Small Lower Body	Pediatric blanket series	125*80cm
		HB05-530	Small Extensions		125*68.4cm
		HB06-560	Catheter chamber	Specialty and cardiac surgery blanket series	193.4*78cm
		HB06-570	Surgical Access		200*110cm
		HB06-630	Sterile Cardiac		125*100cm
		HB06-645	Sterile Access Cardiac Blanket		164.4*78.1cm



## Temperature Measurement

OEM Manufacturer & Models	Instrument Connector	Yoke Probe Side	OEM #	Order Code	Length	Descriptions	Application	Pice
<b>Compatible Welch Allyn</b>								
Welch Allyn Sure Temp Plus 690, SureTemp Plus 692, Spot vital signs LXI Sevice, Vital Signs Monitor 300 Series			02895-000	W0132K	2.7m/9ft	8pin,NTC/R25=20K	Oral	D0
			02892-000	W0132V	2.7m/9ft	8pin,NTC/R25=20K	Rectal	D0
<b>Compatible GE</b>								
GE Dinamap V100; Dinamap Pro Series (Pro 110/ 210/310/410); Dinamap Pro Series V2 (Pro 200 V2 /400 V2); Dinamap Pro Care Series(Pro Care 200/400/220DPC/ DPC400N); Dinamap Pro 1000 V3 ,etc.			2008774-001	W0018K	2.7m/9ft	NTC/R25=10K	Oral	D0
			2008775-001	W0018V	2.7m/9ft	NTC/R25=10K	Rectal	D0



## ECG Cables & Leadwires

### Compliance with Package

ANSI/AAMI SP10	Reusable: 1 pcs/bag
EN 60604-1	Disposable: 24
ISO 10993-1	pcs/box for
ISO 10993-5	neonatal size, and
ISO 10993-10	10 pcs/box for
	others

### Lead Position Marked

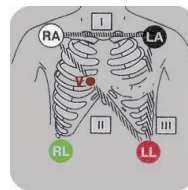

5 Lead: A  
Standard AHA

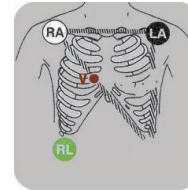

3 Lead: H  
Standard AHA

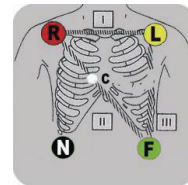

5 Lead: I  
Standard IEC

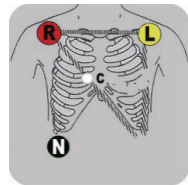

3 Lead: IH  
Standard IEC

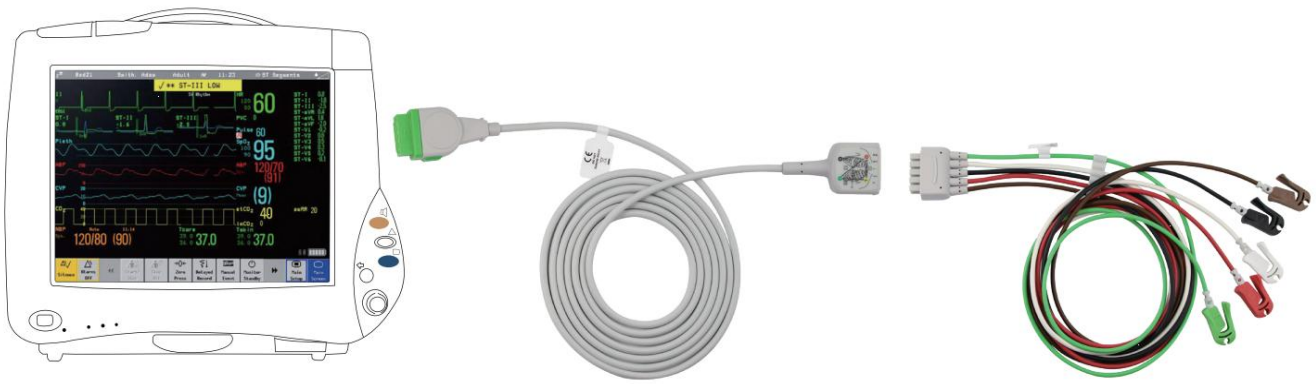

**Instrument Connector**

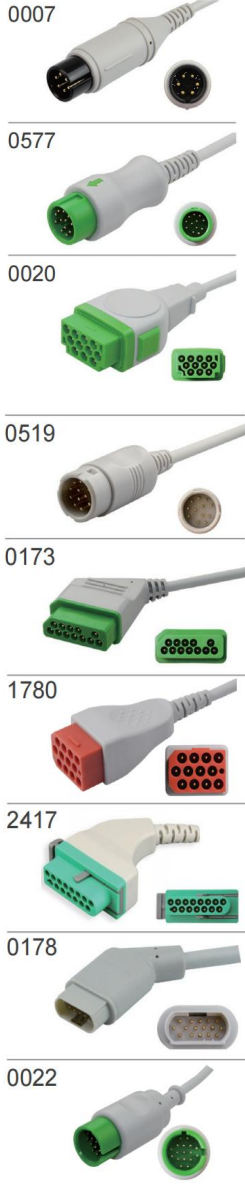

**Yoke Type**



**Leadwire Connector**



**Patient end connector**

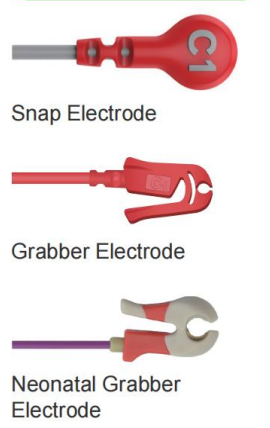

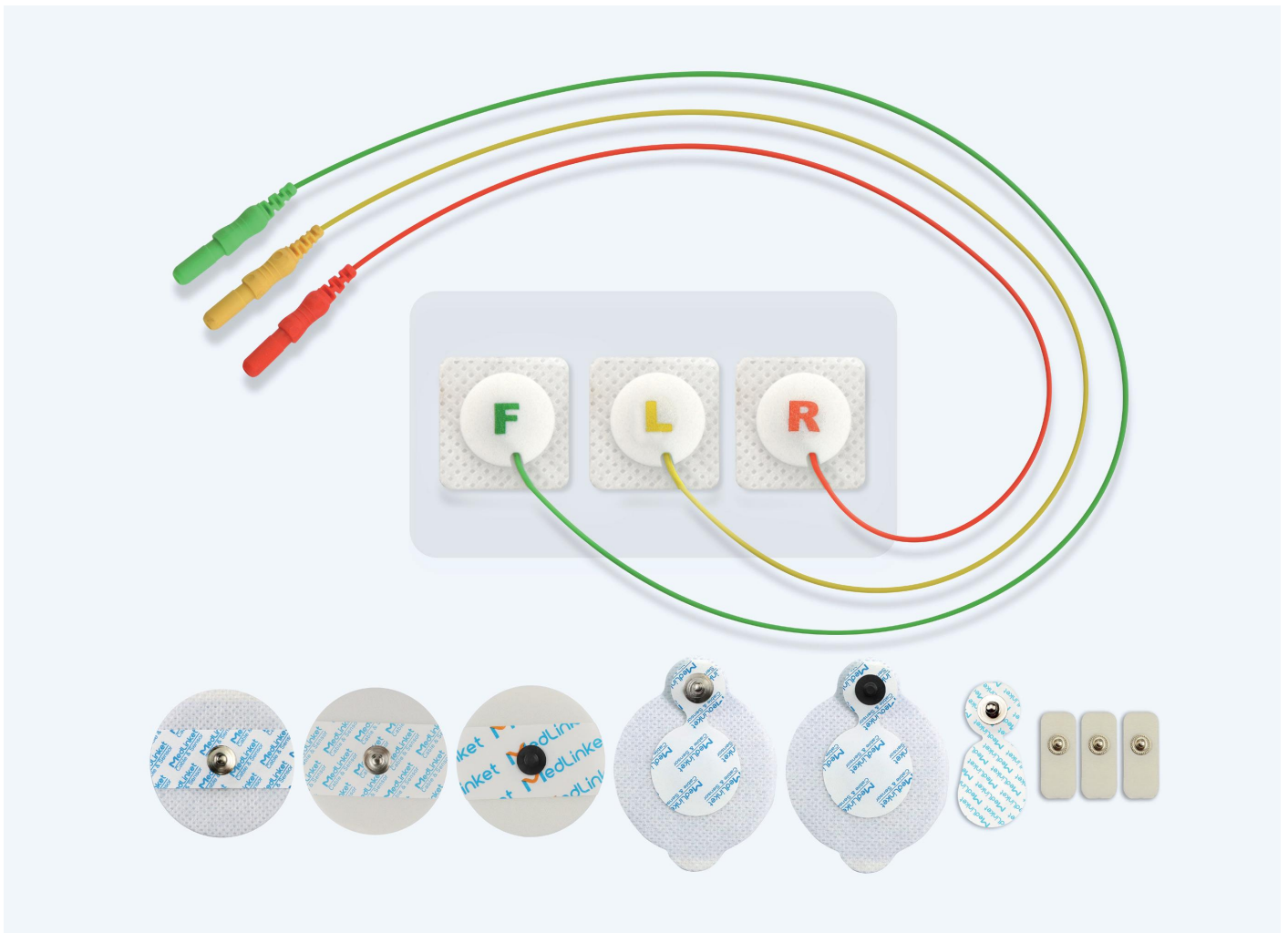









# 1 Disposable ECG Electrodes

## Product Features















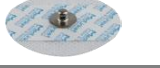

1. The product is suitable for different patients; newborns, children, adults;
2. The product is suitable for different departments; such as diagnosis, monitoring, telemetry, DR, CT, MRI (X-ray);
3. High-quality medical pressure-sensitive adhesive provides strong adhesion, and will not fall off easily even when sweating;
4. Use unique polymerization technology to reduce skin rashes and skin disorders;
5. Latex free, plasticizer free, mercury free.

**According to the different needs of customers, we can provide customized designs of different materials, shapes and patterns.**





## Disposable ECG Electrodes(Standard Type)

Product Guide	Order Code	Descriptions					Applicable Place	Patient size
		Connector Material	Connector Material	Gel type	Size (mm)	Packaging		
	V0014A	Non-woven	4mm metal Grabber ECG electrode	Hydrogel	Φ50	25pcs/bag, 250pcs/box	ECG diagnosis, ECG monitoring, ECG workstation, Telemetry (Holter) ECG	Adult
	V0014AP	Foam	4mm metal Grabber ECG electrode	Hydrogel	Φ50	25pcs/bag, 250pcs/box		Adult
	V0014C	Foam	4mm metal Grabber ECG electrode	Hydrogel	Φ30	25pcs/bag, 250pcs/box		Pediatric
	V0014CP	Non-woven	4mm metal Grabber ECG electrode	Hydrogel	Φ42	25pcs/bag, 250pcs/box		Pediatric
	V0014C-I	Foam	4mm metal Grabber ECG electrode	Hydrogel	Φ25	25pcs/bag, 250pcs/box		Neonates
	V0014D	Foam	2.5mm metal Grabber ECG electrode ( Compatible Medlinket V0010N electrocardiograph adapter, connect 12-Led electrocardiograph banana plug	Hydrogel	10*25	10pcs/bag, 500pcs/box		Neonates
	V0014A-H	Non-woven	4mm metal snap ECG electrode	Hydrogel	70.5*55	20pcs/bag, 400pcs/box		Adult/ Pediatric
	9902040501	Foam	4mm metal snap ECG electrode	Wet gel	29.2*22	20pcs/bag, 400pcs/box	BIS Module (Bispectral index) Telemetry (Holter) ECG	Adult

# Disposable ECG Electrodes(Hypoallergenic Series)

Pictures	Order Code	Size (mm)	Description	Sterile	Radiolucent	Shelf-life (mo.)	Patient indication	Applicable Place	Packaging	
	V0014HL-S	70.5*5 5	4mm metal Grabber ECG electrode Non-woven	√	×	2 years	Adult	ECG diagnosis, ECG monitoring ECG workstation, Telemetry (Holter)ECG	Note: Sterilization package: 10pcs/bag (5+5) Non-sterile packaging: 20pcs/bag 400pcs/box	
	V0014HL			×						
	V0014FL-S	50.5*3 5	4mm metal Grabber ECG electrode Non-woven	√	×	2 years	Pediatric	ECG diagnosis, ECG monitoring ECG workstation, Telemetry (Holter)ECG		
	V0014FL			×						
	V0015HL-S	70.5*5 5	4mm metal Grabber ECG electrode Non-woven	√	×	2 years	Adult	Better suitable for CT(x-ray), DR(X-ray), DSA(X-ray), MR.		
	V0015HL			×						
	V0015FL-S	50.5*3 5	4mm metal Grabber ECG electrode Non-woven	√	×	2 years	Pediatric	Better suitable for CT(x-ray), DR(X-ray), DSA(X-ray), MR.		
	V0015FL			×						
	V0014AL-S	Φ50	4mm metal Grabber ECG electrode Non-woven	√	×	2 years	Adult	General Monitoring		
	V0014AL			×						
	V0014NL-S	Φ42		4mm metal Grabber ECG electrode Non-woven	√	×	2 years		Pediatric	
	V0014NL				×					
	V0014CL-S	Φ30		4mm metal Grabber ECG electrode Non-woven	√	×	2 years		Pediatric	
	V0014CL				×					
	V0014IL-S	Φ25		4mm metal Grabber ECG electrode Non-woven	√	×	2 years		Neonates	
	V0014IL				×					
	V0015AL-S	Φ50		4mm Carbon plastic snap, Non-woven	√	√	2 years		Adult	Better suitable for CT(x-ray), DR(X-ray), DSA(X-ray), MR.
	V0015AL				×					
	V0015NL-S	Φ42	4mm Carbon plastic snap, Non-woven		√	√	2 years	Pediatric		
	V0015NL				×					
	V0015CL-S	Φ30	4mm Carbon plastic snap, Non-woven		√	√	2 years	Pediatric		
	V0015CL				×					
	V0015IL-S	Φ25	4mm Carbon plastic snap, Non-woven		√	√	2 years	Neonates		
	V0015IL				×					
	V0015HL-S	70.5*5 5	4mm Carbon plastic snap, Non-woven		√	√	2 years	Adult	Better suitable for CT(x-ray), DR(X-ray), DSA(X-ray), MR.	
	V0015FL-S	50.5*3 5			√		2 years			
	V0014HL-S	70.5*5 5	4mm metal Grabber ECG electrode Non-woven	√	√	2 years	Adult	ECG diagnosis, ECG monitoring ECG workstation, Telemetry (Holter) ECG		
	V0014FL-S	50.5*3 5		√		2 years			Pediatric	

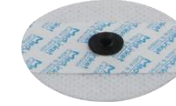
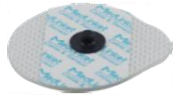
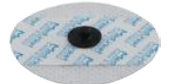
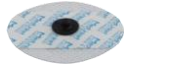

# Disposable ECG Electrodes(Hypoallergenic Series)

Pictures	Order Code	Size (mm)	Description	Sterile	Radiolucent	Shelf-life (mo.)	Patient indication	Applicable Place	Packaging
	V0015HL-S	70.5*55	4mm metal Grabber ECG electrode Non-woven	√	×	2 years	Adult	Better suitable for CT(x-ray), DR(X-ray), DSA(X-ray), MR.	
	V0015HL			×					
	V0015FL-S	50.5*35	4mm Carbon plastic snap, Non-woven	√	×	2 years	Pediatric		
	V0015FL			×					
	V0015AL-S	Φ50	4mm Carbon plastic snap, Non-woven	√	√	2 years	Adult		
	V0015AL			×					
	V0015NL-S	Φ42	4mm Carbon plastic snap, Non-woven	√	√	2 years	Pediatric	Better suitable for CT(x-ray), DR(X-ray), DSA(X-ray), MR.	
	V0015NL			×					
	V0015CL-S	Φ30	4mm Carbon plastic snap, Non-woven	√	√	2 years	Pediatric		
	V0015CL			×					
	V0015IL-S	Φ25	4mm Carbon plastic snap, Non-woven	√	√	2 years	Neonates		
	V0015IL			×					
	V0015HL-S	70.5*55	4mm Carbon plastic snap, Non-woven	√	√	2 years	Adult	Better suitable for CT(x-ray), DR(X-ray), DSA(X-ray), MR.	
	V0015FL-S	50.5*35		√		2 years	Pediatric		

# ECG(ECG Radiolucent Lead Wires)

OEM Manufacturer & Models	Product Guide	OEM #	Order Code	Lead #	Descriptions	Price
<b>Philips HP Type ECG Leadwires Set</b>						
Philips MP series(MP20/30/40/50/60/70/80/90), MX series(MX400/450/500/550)etc.			RDG040C5A	5-Ld	Radiolucent ECG Lead Wires, 69g Reusable, Grabber clip,AHA, 40 Inches	MO
			RDG040C5I	5-Ld	Radiolucent ECG Lead Wires,69g, Reusable, Grabber clip, IEC, 40 Inches	MO
			RDG040C3A	3-Ld	Radiolucent ECG Lead Wires, 47g, Reusable, Grabber clip, AHA, 40 Inches	JO
			RDG040C3I	3-Ld	Radiolucent ECG Lead Wires, Reusable, Grabber clip, 47g, IEC, 40 Inches	JO
<b>Philips DIN Type ECG Leadwires Set</b>						
PHILIPS MR400		9898031 93761	RC040C4A	4-Ld	DIN type, Radiolucent ECG Lead Wires,Reusable, Grabber clip, AHA, 40 Inches	X0+M8
			RC040C4I	4-Ld	DIN type, Radiolucent ECG Lead Wires,Reusable, Grabber clip, IEC, 40 Inches	X0+M8
<b>Mindray EURO Type ECG Leadwires Set</b>						
Mindray Benevision N series, BeneView T series, iMEC series, uMEC series, iPM series, ePM series etc.			RJ075C5A	5-Ld	Radiolucent ECG Lead Wires, Reusable, Grabber clip, AHA, 40 Inches, 72g	MO
			RJ075C5I	5-Ld	Radiolucent ECG Lead Wires, Reusable, Grabber clip, IEC, 40 Inches, 57g	MO
			RJ075C3A	5-Ld	Radiolucent ECG Lead Wires, Reusable, Grabber clip, AHA, 40 Inches, 57g	JO
			RJ075C3I	5-Ld	Radiolucent ECG Lead Wires, Reusable, Grabber clip, IEC, 40 Inches, 57g	JO

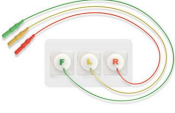































# ECG(Disposable ECG Electrodes)

OEM Manufacturer & Models	Product Guide	Order Code	Descriptions	Applicable Place	Package
<b>Disposable ECG electrodes (with wire)</b>					
Monitor with ECG main cable adapted to Din-type splitter		V0014-C0243A	3 LD,AHA,600 mm	All ECG monitoring, ECG studio(diagnosing Holter)	3pcs(1set)/bag 25set/box
		V0014-C0243I	3 LD,IEC,600 mm		
		V0014-C0245A	5LD,AHA,600 mm		
		V0014-C0245I	5LD,IEC,600 mm		
		V0014C-C0403A	3 LD,AHA,1000 mm		
		V0014C-C0403I	3 LD,IEC,1000 mm		
<b>Disposable Radiolucent ECG electrodes (with wire)</b>					
Monitor with ECG main cable adapted to Din-type splitter		V0015-C0243A	3 LD,AHA,680 mm	DR (x-ray) CT (x-ray) CR(x-ray) DSA(x-ray)	3pcs(1set)/bag 25set/box
		V0015-C0243I	3 LD,IEC,680 mm		
		V0015-C0603A	3 LD,AHA,1200 mm		
		V0015-C0603I	3 LD,IEC,1200 mm		
		V0015-C0845A	5 LD,AHA,1200 mm		
		V0015-C0845I	5 LD,IEC,1200 mm		
ECG Patient monitor (Radiotransparent)		V0015-C0485I	5 LD,IEC,1200 mm	DR (x-ray) CT (x-ray) CR(x-ray) DSA(x-ray)	5pcs(1set)/bag 25set/box
		V0015-C0485A	5 LD,AEC,1200 mm		

# ECG(Disposable ECG Electrodes)

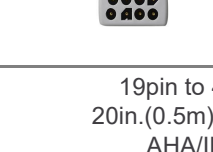
OEM Manufacturer & Models	Connector	Yoke (Leads Side)	OEM#	Order Code	Descriptions	Price
<b>Compatible Comen</b>						
C60				EC404-3AI	Neonatal DIN 3-lead, AHA/IEC, 2.7 m/9 ft.	C0
<b>Compatible Drager</b>						
Infinity Kappa series, Gamma series, Delta series, Vista series, etc.			MS20094	EQ091-6AI	16-pin connector, 5 Lead, AHA/IEC, 2.5m	C0
				EC080-3AI	N6-pin connector, used with Din leads, 3 Lead, IEC/AHA, 2.5m	C0
<b>Compatible Mindray</b>						
BeneView, IPM, ePM, IMC, UMEC Series				EC050-3AI	Neonatal DIN 3-lead, AHA/IEC, 2.7m/9ft	C0
PM Series, MEC Series, Datascope XL Series				EC020-3AI	Neonatal DIN 3-lead, AHA/IEC, 2.7m/9ft	B9
<b>Compatible Nihon Kohden</b>						
Nihon Kohden LifeScope ABSM5105, BSM5135, Life Scope PBSM-4103K, BSM-4113; Life Scopel BSM-2301K, BSM-2303, etc.				EC055-3AI	Neonatal DIN 3-lead, AHA/IEC, 2.7m/9ft	C0
<b>Compatible Philips</b>						
Philips MP series (MP20/30/40/50/60/70/80/90), MX series (MX400/450/500/550) etc				EC023-3A	Neonatal DIN 3-lead, AHA/IEC, 2.7m/9ft	C0
<b>Compatible GE</b>						
GE Marquette: CARESCAPE series: B450, B650, B850 etc. DASH series: B20, B40, B105, B125, B155 etc.			2106306-001/ 2017004-001 2106306-003/ 2017004-003	EC007-3AI	11-pin connector, used with Din leads, 3 Lead, IEC/AHA, 2.7m/9 ft	C0





# ECG(Disposable ECG Electrodes)









OEM Manufacturer & Models	ECG Trunk Cables		Adapter		Disposable ECG Electrodes	
	Product Picture	Order Code	Product Picture	Order Code	Product Picture	Order Code
Compatible Mindray: BeneVision N series, BeneView T series, IPM series, MEC series etc.		EJ050-5AI		EMAJ-5AI		1705101132 (AHA)
		EJ050-3AI		EMAJ-3AI		1705101131 (IEC)
Compatible Philips: MP series; MX series; SureSigns VM series (VM4, VM6, VM8). Compatible Goldway: CM series etc.		EDG073-5AI		EMADG-5AI		1705101152 (AHA)
		EDG073-3AI		EMADG-3AI		1705101152 (AHA)
Compatible GE Marquette: CARESCAPE series: B450, B650, B850 etc. DASH series: B20, B40, B105,		EE007-5AI		EMAE-5AI		1705101152 (AHA)
		EE007-3AI		EMAE-3AI		
Drager Innity Kappa series, Gamma series, Delta series, Vista series		EQ056-5AI		EMASM-3AI		94051162A (AHA) 94051162I (IEC)
				EMASM-5AI		
		EQ091-6AI		EMAQ-3AI		
				EMAQ-5AI		
Compatible Nihon Kohden Lifescope series BSM-1700 series BSM-6301C/6501C/6701C BSM-3562/3763 etc.		EP055-6I		EMAP-3AI		94051162A (AHA) 94051162I (IEC)
				EMAP-6AI		
Compatible BIOX	19pin to 4pin , 20in.(0.5m),3-LD, AHA/IEC			HMA201-3AI		
	19pin to 4pin , 20in.(0.5m),5-LD, AHA/IEC			HMA201-5AI		

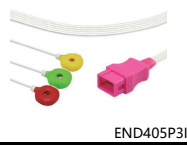











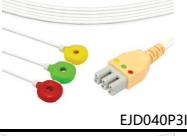

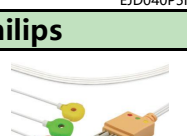

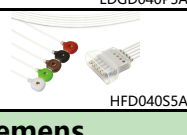
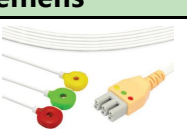

























## 2 Disposable ECG Leadwires

### Product Advantages

Photo	Feature	Advantage
	Single Patient Use	Decreases the risk of cross contamination and improves patient care.
	Fully Shielded Leadwires Design	Reduces the risk of Electromagnetic Interference (EMI).
	Peelable Ribbon Cable Design	Prevents lead wire entanglement and can be customized to fit any patient's body size.
	Side button and visual connection design	(1) Provide clinicians with a locking and visualization mechanism to achieve faster, efficient and firm connections; (2) Clinically proven to reduce the risk of "leads off" false alarms.
	Easy to used electrode colors Lightweight smooth design	(1) Easy and quick lead placement; (2) Increase patient comfort.

Compatible Models	Product Picture	OEM #	Lead #	Descriptions	Order Code	Price
<b>Compatible Covidien</b>						
Covidien (Bedside Monitoring)	 END405P3I	33103	3	Snap, 124 in. (315 cm), AHA	END405P3A	
				Snap, 124 in. (315 cm), IEC	END405P3I	
			3	Grabber, 124 in. (315 cm), AHA	END405C3A	
				Grabber, 124 in. (315 cm), IEC	END405C3I	
	 END405P5I	33105 33105E	5	Snap, 124 in. (315 cm), AHA	END405P5A	
				Snap, 124 in. (315 cm), IEC	END405P5I	
		5	Grabber, 124 in. (315 cm), AHA	END405C5A		
			Grabber, 124 in. (315 cm), IEC	END405C5I		
Covidien (Radiolucent Monitoring)	 RND405C3I	33136R36	3	Grabber, 124 in. (315 cm), AHA	RND405C3A	
				Grabber, 124 in. (315 cm), IEC	RND405C3I	
			5	Grabber, 124 in. (315 cm), AHA	RND405C5A	
				Grabber, 124 in. (315 cm), IEC	RND405C5I	
<b>Compatible DIN Type Connector</b>						
DIN Type	 ECD040P3I	M3915A (PHILIPS)	3	Snap, 40 in. (100 cm), AHA	ECD040P3A	
				Snap, 40 in. (100 cm), IEC	ECD040P3I	
		900716-001 (GE)	3	Grabber, 40 in. (100 cm), AHA	ECD040C3A	
				Grabber, 40 in. (100 cm), IEC	ECD040C3I	
<b>Compatible Drager</b>						
Drager Gamma/ Gamma XL/ Gamma X XL Delta/Delta XL Kappa/Kappa XLT Vista/Vista XL	 EQD040P3I	MS14556	3	Snap, 40 in. (100 cm), AHA	EQD040P3A	
				Snap, 40 in. (100 cm), IEC	EQD040P3I	
		MP00877 MP00875	3	Grabber, 40 in. (100 cm), AHA	EQD040C3A	
				Grabber, 40 in. (100 cm), IEC	EQD040C3I	
		MS14560 MS14559	5	Snap, 40 in. (100 cm), AHA	EQD040P5A	
				Snap, 40 in. (100 cm), IEC	EQD040P5I	
	MP00881 MP00879	5	Grabber, 40 in. (100 cm), AHA	EQD040C5A		
			Grabber, 40 in. (100 cm), IEC	EQD040C5I		
	 EQD040P6A	MS14682 MS14683	6	Snap, 40 in. (100 cm), AHA	EQD040P6A	
				Snap, 40 in. (100 cm), IEC	EQD040P6I	
		MP03123 MP03122	6	Grabber, 40 in. (100 cm), AHA	EQD040C6A	
				Grabber, 40 in. (100 cm), IEC	EQD040C6I	
		3	Grabber, 36 in. (0.92m), AHA	EQ035C3A		
			Grabber, 36 in. (0.92m), IEC	EQ035C3I		
<b>Compatible Datex (ASP Style Types)</b>						
Bedside Monitoring	 EHD040P3I		3	Snap, 40 in. (100 cm), AHA	EHD040P3A	
				Snap, 40 in. (100 cm), IEC	EHD040P3I	
			3	Grabber, 40 in. (100 cm), AHA	EHD040C3A	
				Grabber, 40 in. (100 cm), IEC	EHD040C3I	
	 EHD040P5A		5	Snap, 40 in. (100 cm), AHA	EHD040P5A	
				Snap, 40 in. (100 cm), IEC	EHD040P5I	
			5	Grabber, 40 in. (100 cm), AHA	EHD040C5A	
				Grabber, 40 in. (100 cm), IEC	EHD040C5I	

Compatible Models	Product Picture	OEM #	Lead #	Descriptions	Order Code	Price	
<b>Compatible GE Multi-link</b>							
Bedside Monitoring	 EED029P3I	E9008LF E9008LH	3	Snap, 29 in. (74 cm), AHA	EED029P3A		
		E9003CL E9003CN	3	Grabber, 29 in. (74 cm), AHA	EED029C3A		
			3	Grabber, 29 in. (74 cm), IEC	EED029C3I		
	 EED029P5A	E9008KB E9008KD	5	Snap, 29in. (74 cm), AHA	EED029P5A		
			5	Snap, 29in. (74 cm), IEC	EED029P5I		
		E9002ZW E9002ZZ	5	Grabber, 29in. (74 cm), AHA	EED029C5A		
5	Grabber, 29in. (74 cm), IEC		EED029C5I				
<b>Compatible Mindray (China)</b>							
Bedside Monitoring	 EJD040P3I	0010-30-42734 0010-30-42733	3	Snap, 40 in. (100 cm), AHA	EJD040P3A		
			3	Snap, 40 in. (100 cm), IEC	EJD040P3I		
		0010-30-42731 0010-30-42732	3	Grabber, 40 in. (100 cm), AHA	EJD040C3A		
	3		Grabber, 40 in. (100 cm), IEC	EJD040C3I			
	 EJD040P5I	0010-30-42735 0010-30-42736	5	Snap, 40 in. (100 cm), AHA	EJD040P5A		
			5	Snap, 40 in. (100 cm), IEC	EJD040P5I		
 EJD040C5I	0010-30-42727 0010-30-42730	5	Grabber, 40 in. (100 cm), AHA	EJD040C5A			
		5	Grabber, 40 in. (100 cm), IEC	EJD040C5I			
<b>Compatible Philips</b>							
Bedside Monitoring	 EDGD040P3I	M1673A M1674A	3	Snap, 40 in. (100 cm), AHA	EDGD040P3A		
			3	Snap, 40 in. (100 cm), IEC	EDGD040P3I		
		989803173121 989803174201	3	Grabber, 40 in. (100 cm), AHA	EDGD040C3A		
	3		Grabber, 40 in. (100 cm), IEC	EDGD040C3I			
	 EDGD040P5A	M1644A M1645A	5	Snap, 40 in. (75cm/100 cm), AHA	EDGD040P5A		
			5	Snap, 40 in. (75cm/100 cm), IEC	EDGD040P5I		
 EDGD040C5I	989803173131 989803174211	5	Grabber, 40 in. (75cm/100 cm), AHA	EDGD040C5A			
		5	Grabber, 40 in. (75cm/100 cm), IEC	EDGD040C5I			
Philips IntelliVue M2600B	 HFD040S5A		5	Grabber, 5PIN, 36in. (92cm), AHA	HFD040S5A		
			5	Grabber, 5PIN, 36in. (92cm), IEC	HFD040S5I		
<b>Compatible Siemens</b>							
	 ESMD040P3I		3	Snap, 40 in. (100 cm), AHA	ESMD040P3A		
			3	Snap, 40 in. (100 cm), IEC	ESMD040P3I		
			3	Grabber, 40 in. (100 cm), AHA	ESMD040C3A		
			3	Grabber, 40 in. (100 cm), IEC	ESMD040C3I		
	 ESMD040P5I		5	Snap, 40 in. (100 cm), AHA	ESMD040P5A		
			5	Snap, 40 in. (100 cm), IEC	ESMD040P5I		
			5	Grabber, 40 in. (100 cm), AHA	ESMD040C5A		
			5	Grabber, 40 in. (100 cm), IEC	ESMD040C5I		
<b>Compatible Spacelabs</b>							
90309, 90367, 90367 Ultraview, 90369, 90369 Ultraview, 90492, 90496, 90496 Ultraview	 ELD040C3I	700-0007-02 700-0007-03	3	Snap, 40 in. (100 cm), AHA	ELD040P3A		
			3	Snap, 40 in. (100 cm), IEC	ELD040P3I		
		700-0006-02 700-0006-03	3	Grabber, 40 in. (100 cm), AHA	ELD040C3A		
			3	Grabber, 40 in. (100 cm), IEC	ELD040C3I		
		700-0007-10 700-0007-09		5	Snap, 40 in. (100 cm), AHA	ELD040P5A	
				5	Snap, 40 in. (100 cm), IEC	ELD040P5I	
700-0006-10 700-0006-11		5	Grabber, 40 in. (100 cm), AHA	ELD040C5A			
		5	Grabber, 40 in. (100 cm), IEC	ELD040C5I			

Compatible Brand	ECG Trunk Cables		Adapter		Disposable ECG Leadwires	
	Product Picture	Order Code	Product Picture	Order Code	Product Picture	Order Code
Compatible Mindray: BeneVision N series,BeneView T series, IPM series,MEC series etc.		EJ050-5AI		EMAJ-5AI		EMAD04 0P3A
		EJ050-3AI		EMAJ-3AI		
Compatible Philips: MP series; MX series; SureSigns VM series (VM4,VM6,VM8). Compatible Goldway: CM series etc.		EDG073-5AI		EMADG-5AI		EMAD04 0P3I
		EDG073-3AI		EMADG-3AI		
Compatible GE Marquette: CARESCAPE series: B450,B650, B850 etc. DASH series: B20,B40,B105, B125,B155 etc.		EE007-5AI		EMAE-5AI		EMAD04 0P5A
				EMAE-3AI		
Drager In_x005fnity Kappa series, Gamma series, Delta series, Vista series		EQ056-5AI		EMASM-3AI		EMAD04 0P5I
				EMASM-5AI		
		EQ091-6AI		EMAQ-3AI		
				EMAQ-5AI		
Compatible Nihon Kohden Lifescope series BSM-1700 series BSM-6301C/6501C/6701C BSM-3562/3763 etc.		EP055-6I		EMAP-3AI		EMAD04 0P5I
				EMAP-6AI		
Compatible BIOX	19pin to 4pin ,20in.(0.5m),3-LD, AHA/IEC			HMA201-3AI		EMAD04 0P5I
	19pin to 4pin ,20in.(0.5m),5-LD, AHA/IEC			HMA201-5AI		

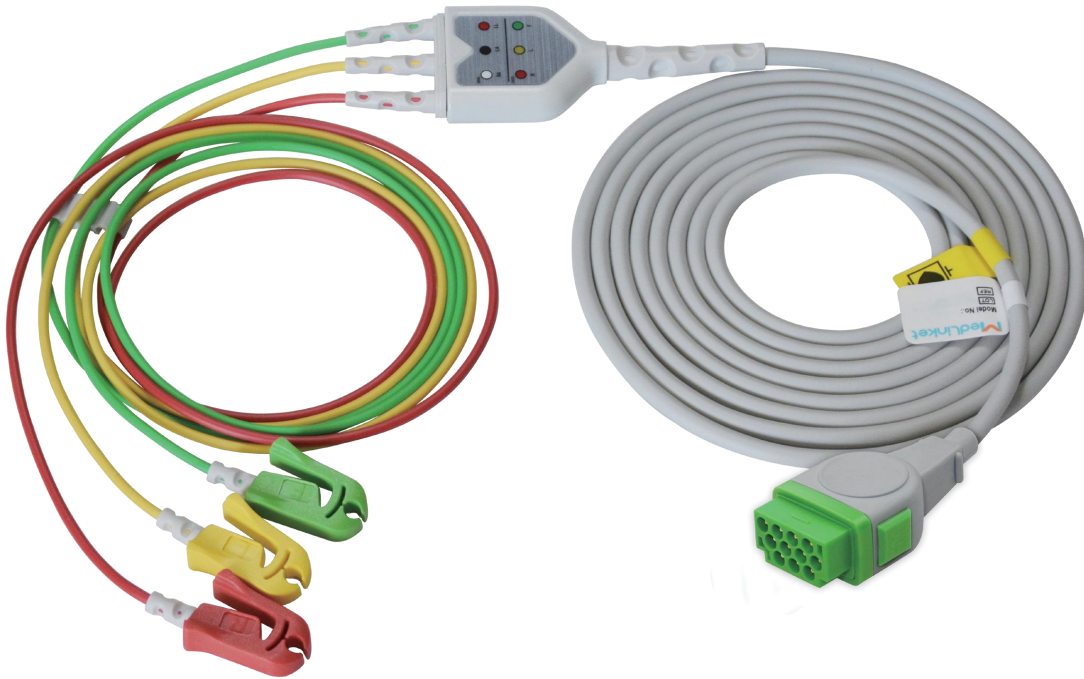

## 3 One Piece ECG Cables

### Type Designation

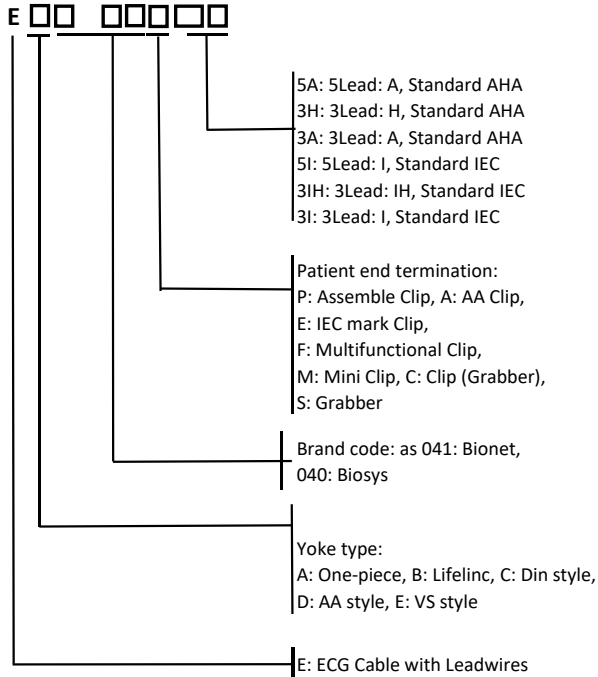

### Product Features

1. For adult and pediatric patients;
2. Meeting the requirements of EC53;
3. Integrated design, convenient for use and maintenance;
4. Flexible and durable cables, enduring repeated cleaning and disinfection;
5. Outstanding shielding property and anti-interference performance, protecting ECG signal from being interfered;
6. The electrode connector has a clear color mark, which can quickly and easily connect the electrode position;
7. Latex free.

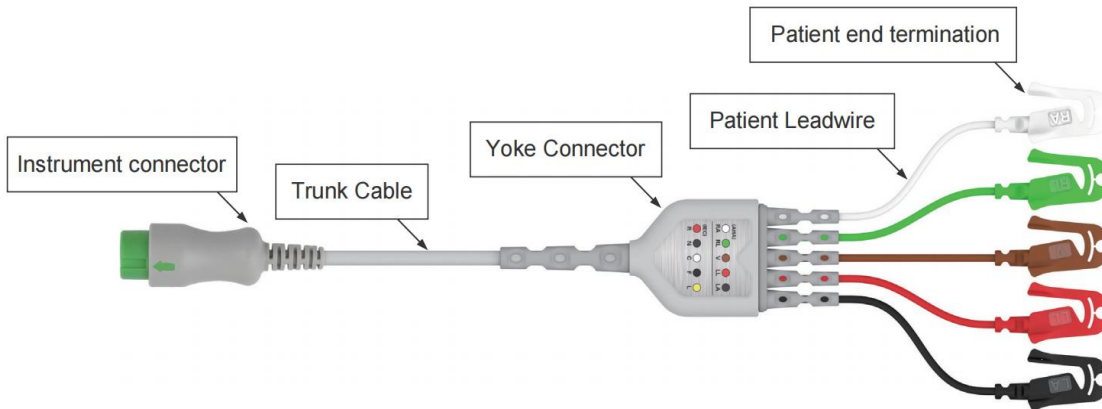

**Patient end connector**



Standard Snap S



Type RL Grabber RL C

0020



0173



**Lead Position Marked**

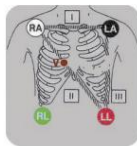

5 Lead: A  
Standard AHA

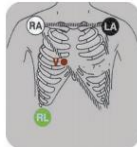

3 Lead: H  
Standard AHA

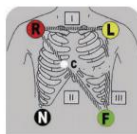

5 Lead: I  
Standard IEC

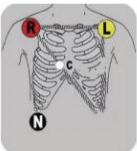

3 Lead: IH  
Standard IEC

**Instrument Connector**

0007



1643













2818







0577







OEM Manufacturer & Models	Connector	OEM #	Descriptions	Order Code	price
<b>Compatible AAMI</b>					
AAMI: all Air Shields ATL BCI Colin Draeger Datascope Edan GE Healthcare Goldway Infinium Invivo Nihon Kohden Philips Spacelabs Medtronic Welch Allyn Zoll			Snap, TPU, 3 Ld, No Resistance, AHA	EA020S3A	B5
			Snap, TPU, 3 Ld, No Resistance, IEC	EA020S3I	B5
			Clip, TPU, 3 Ld, No Resistance, AHA	EA020C3A	B6
			Clip, TPU, 3 Ld, No Resistance, IEC	EA020C3I	B6
			Snap, TPU, 5 Ld, No Resistance, AHA	EA020S5A	B6
			Snap, TPU, 5 Ld, No Resistance, IEC	EA020S5I	B7
			Clip, TPU, 5 Ld, No Resistance, AHA	EA020C5A	B7
			Clip, TPU, 5 Ld, No Resistance, IEC	EA020C5I	B8
			Snap, TPU, 3 Ld, 1kΩ, AHA	EA021S3A	B8
			Snap, TPU, 3 Ld, 1kΩ, IEC	EA021S3I	B9
			Clip, TPU, 3 Ld, 1kΩ, AHA	EA021C3A	B9
			Clip, TPU, 3 Ld, 1kΩ, IEC	EA021C3I	B9
			Snap, TPU, 5 Ld, 1kΩ, AHA	EA021S5A	B9
			Snap, TPU, 5 Ld, 1kΩ, IEC	EA021S5I	B9
			Clip, TPU, 5 Ld, 1kΩ, AHA	EA021C5A	B0
			Clip, TPU, 5 Ld, 1kΩ, IEC	EA021C5I	B0
			Snap, PVC, 3 Ld, No Resistance, AHA	E0020J	A0
			Snap, PVC, 3 Ld, No Resistance, IEC	E0020K	A0
			Snap, PVC, 5 Ld, No Resistance, AHA	E0002J	B2
			Snap, PVC, 5 Ld, No Resistance, IEC	E0002K	B2
	Clip, PVC, 3 Ld, No Resistance, IEC	E0002W	A0		
<b>Compatible AAMI</b>					
Compatible Bexen			Snap, 5-Lead, AHA, 1kΩ, 12ft(3.6m)	EA419S5A	C4
			Snap, 5-Lead, IEC, 1kΩ, 12ft(3.6m)	EA419S5I	C4
<b>Compatible Bionet (Korea)</b>					
BM3			Snap, TPU, 3 Ld, 1kΩ, AHA	EA041S3A	B9
			Snap, TPU, 3 Ld, 1kΩ, IEC	EA041S3I	B9
			Grabber, TPU, 3Ld, 1kΩ, AHA	EA041S5A	C1
			Grabber, TPU, 3Ld, 1kΩ, IEC	EA041S5I	C1

OEM Manufacturer & Models	Connector	OEM #	Descriptions	Order Code	price
<b>Compatible Bionet (Korea)</b>					
BM5 BM7			Snap,TPU,3Ld,No Resistance,AHA	EA400S3A	C4
			Snap,TPU,3Ld,No Resistance,IEC	EA400S3I	C4
			Grabber,TPU,3Ld,No Resistance,AHA	EA400C3A	C4
			Grabber,TPU,3Ld,No Resistance,IEC	EA400C3I	C4
			Snap,TPU,5Ld,No Resistance,AHA	EA400S5A	C6
			Snap,TPU,5Ld,No Resistance,IEC	EA400S5I	C6
			Grabber,TPU,5Ld,No Resistance,AHA	EA400C5A	C6
			Grabber,TPU,5Ld,No Resistance,IEC	EA400C5I	C6
BPM-103			Snap,TPU,5 Ld,No Resistance,IEC	EA040S5I	C1
<b>Compatible Bruker (Odam)</b>					
SM784 SM785			Clip,TPU,3 Ld,No Resistance,IEC	EA017C3I	C4
			Clip,TPU,4 Ld,No Resistance,IEC	EA017C3IH	C4
<b>Compatible Biolight (China)</b>					
Creative: PC9000S, PC9000, UP6000, Biolight: M12			Grabber,TPU,3 Ld,No Resistance,AHA	EA046S3A	B9
			Grabber,TPU,3 Ld,No Resistance,IEC	EA046S3I	B9
			Grabber,TPU,5 Ld,No Resistance,AHA	EA046S5A	C1
			Grabber,TPU,5 Ld,No Resistance,IEC	EA046S5I	C1
			Snap,TPU,3Ld,1KΩ,AHA	EA417S3A	C4
			Snap,TPU,3Ld,1KΩ,IEC	EA417S3I	C4
			Grabber,TPU,3Ld,1KΩ,AHA	EA417C3A	C4
			Grabber,TPU,3Ld,1KΩ,IEC	EA417C3I	C4
			Snap,TPU,5Ld,1KΩ,AHA	EA417S5A	C6
			Snap,TPU,5Ld,1KΩ,IEC	EA417S5I	C6
			Grabber,TPU,5Ld,1KΩ,AHA	EA417C5A	C6
			Grabber,TPU,5Ld,1KΩ,IEC	EA417C5I	C6
<b>Compatible Colin (Omron), Also See AAMI</b>					
BP88S			Clip, TPU, 3 Ld, No Resistance, IEC	EA061C3I	C0
<b>Compatible Corpuls</b>					
Corpuls 08/16, 0816M			Clip, TPU, 4 Ld, 1KΩ, IEC	EA076C3IH	E0

OEM Manufacturer & Models	Connector	OEM #	Descriptions	Order Code	price
<b>Compatible Comen (China)</b>					
COMEN: C20, C21, C30, C50, C70, C90, C100, C100A, NC3, NC5, NC8, NC10, NC12,NC19		040-00032000(AHA)	Snap,TPU,3Ld,1kΩ,AHA	EA414S3A	C4
			Snap,TPU,3Ld,1kΩ,IEC	EA414S3I	C4
		040-00036800(AHA)	Grabber,TPU,3Ld,1kΩ,AHA	EA414C3A	C4
			Grabber,TPU,3Ld,1kΩ,IEC	EA414C3I	C4
		040-00032100(AHA)	Snap,TPU,5Ld,1kΩ,AHA	EA414S5A	C6
			Snap,TPU,5Ld,1kΩ,IEC	EA414S5I	C6
		040-00036900(AHA)	Grabber,TPU,5Ld,1kΩ,AHA	EA414C5A	C6
			Grabber,TPU,5Ld,1kΩ,IEC	EA414C5I	C6
<b>Compatible Creative (China), See Biolight/Air Shields</b>					
<b>Compatible Corpuls</b>					
Drager UM1/3/3.1, RM1, PM8010, PM8014, Babyguard 8000, Cato, Babylog8000/8000 plus, PB8800Serie 8000, Cicero,			Clip, TPU, 3 Ld, No Resistance, IEC	EA057C3I	E1
<b>Compatible Datex</b>					
AS/3, CS/3, Cardiocap 1, Cardiocap 2, Cardiocap 5, Light Monitor, Satelliteplus			Clip,TPU,3 Ld,No Resistance,IEC	EA010C3I	C8
			Snap,TPU,3 Ld,No Resistance,AHA	EA010S3A	C7
			Clip,TPU,5 Ld,No Resistance,IEC	EA010C5I	C0
			Clip,TPU,3 Ld,No Resistance,AHA	EA010C3A	C8
			Snap,TPU,5 Ld,No Resistance,IEC	EA010S5I	C9
			Snap,TPU,3 Ld,No Resistance,IEC	EA010S3I	C7
			Snap,TPU,5 Ld,No Resistance,AHA	EA010S5A	C9
CS/3			Clip,TPU,3 Ld,4.7KΩ,IEC	EA091C3I	D5
<b>Compatible Fukuda Denshi</b>					
DS5100E, DS5300W DS5400 Datascope: Expert MENNEN			Clip,TPU,5 Ld,1KΩ,IEC	EA068C5	D5
			Clip,TPU,3 Ld,1KΩ,IEC	EA068C3I	D4
			Snap,TPU,3 Ld,1KΩ,IEC	EA068S3I	D3
<b>Compatible GE-Marquette</b>					
Dash 1000/2500/5000, Dash PRO series, Eagle Systems, MAC-Lab, Solar series, Aestiva/5, Tram series, Responder2000/3000, Corometrics 120, GE Vivid 7 Ultrasound, Datex Ohmeda E Prestin modules and Unity Systems			Snap,TPU,3 Ld,No Resistance,AHA	EA007S3A	C6
			Snap,TPU,3 Ld,No Resistance,IEC	EA007S3I	C6
			Clip,TPU,3 Ld,No Resistance,AHA	EA007C3A	C7
			Clip,TPU,3 Ld,No Resistance,IEC	EA007C3I	C7

OEM Manufacturer & Models	Connector	OEM #	Descriptions	Order Code	price
<b>Compatible GE-Marquette</b>					
Dash 1000/2500/5000, Dash PRO series, Eagle Systems, MAC- Lab, Solar series, Aestiva/5, Tram series, Responder2000/3000, Corometrics 120, GE Vivid 7 Ultrasound, Datex Ohmeda E Prestin modules and Unity Systems			Clip,TPU,5 Ld,No Resistance,AHA	EA007C5A	C8
			Clip,TPU,5 Ld,No Resistance,IEC	EA007C5I	C8
			Snap,TPU,5 Ld,No Resistance,AHA	EA007S5A	C7
			Snap,TPU,5 Ld,No Resistance,EC	EA007S5I	C7
GE-MEDICAL PRO1000		See AAMI			
<b>Compatible Hellige</b>					
Hellige, Servomed 4, Generation, SCP 851, SCP 852, SCP 844,SCS 804,CardioServ, VICOM-sm			Clip,TPU,3 Ld,No Resistance,IEC	EA011C3I	C0
			Snap,TPU,3 Ld,No Resistance,AHA	EA011S3A	C0
			Clip,TPU,5 Ld,No Resistance,AHA	EA011C5A	D5
			Snap,TPU,5 Ld,No Resistance,IEC	EA011S5I	D4
<b>Compatible Kontron</b>					
7000, 7135, 7135B, 7141, 72107250, 7251, K2000, KAAT,Kolormon, Micromon, Minimon.			Clip,TPU,5 Ld,No Resistance,IEC	EA031C5I	C6
			Clip,TPU,3 Ld,No Resistance,IEC	EA031C3I	C4
<b>Compatible Mek (Korea)</b>					
MP1000,MP600,MP 500			Clip, TPU, 3 Ld, No Resistance, IEC	EA029C3I	B8
Mek(Korea)(M160246)			Grabber,5Ld, No Resistance, IEC	EA033C5I	B0
<b>Compatible M&amp;B (China)</b>					
			Snap, TPU, 3 Ld, No Resistance, AHA	EA072S3A	C4
<b>Compatible Medtronic</b>					
Lifepak 12, 120, Lifepak 20			Snap,TPU,5 Ld,10KΩ,AHA	EA066S5A	D5
			Snap,TPU,5 Ld,10KΩ,IEC	EA066S5I	D5
			Snap,TPU,3 Ld,10KΩ,AHA	EA066S3A	C0
			Snap,TPU,3 Ld,10KΩ,IEC	EA066S3I	C0
			Clip,TPU,3 Ld,10KΩ,IEC	EA066C3I	C0
PHYSIO-CONTROL: Lifepak 2, 3, 33, Scope Monitor II; SIEMENS: Porta Pak 500PB, Porta Pak 500PM			Snap, TPU, 3 Ld, No Resistance, AHA	EA067S3A	B9

OEM Manufacturer & Models	Connector	OEM #	Descriptions	Order Code	price
<b>Compatible Mindray (China)</b>					
PM7000/8000 /9000			Clip,TPU,3 Ld,No Resistance,IEC	EA085C3I	B6
			Snap,TPU,5 Ld,No Resistance,AHA	EA085S5A	B8
			Snap,TPU,5 Ld,No Resistance,IEC	EA085S5I	B8
			Clip,TPU,5 Ld,No Resistance,IEC	EA085C5I	B9
			Snap,TPU,3 Ld,No Resistance,AHA	EA085S3A	B5
			Snap,TPU,3 Ld,No Resistance,IEC	EA085S3I	B5
			Grabber,TPU,3Ld,No Resistance,AHA	EA085C3A	B5
			Grabber,TPU,5Ld,No Resistance,AHA	EA085C5A	B5
MEC1000, MEC1200			See AAMI		
BeneView (T5, T6, T8) iPM series			Clip,TPU,3 Ld,1KQ,AHA	EA050C3A	C8
			Clip,TPU,3 Ld,1KQ,IEC	EA050C3I	C8
			Snap,TPU,5 Ld,1KQ,AHA	EA050S5A	C9
			Snap,TPU,5 Ld,1KQ,IEC	EA050S5I	C9
			Snap,TPU,3 Ld,1KQ,AHA	EA050S3A	C7
			Snap,TPU,3 Ld,1KQ,IEC	EA050S3I	C7
			Clip,TPU,5 Ld,1KQ,AHA	EA050C5A	C0
			Clip,TPU,5 Ld,1KQ,IEC	EA050C5I	C0
PM5000/6000			Clip,TPU,3 Ld,No Resistance,IEC	EA060C3I	C3
			Snap,TPU,3 Ld,No Resistance,AHA	EA060S3A	C3
			Snap,TPU,5 Ld,No Resistance,AHA	EA060S5A	C3
			Snap,TPU,5 Ld,No Resistance,IEC	EA060S5I	C3
<b>Compatible Nihon Kohden</b>					
NIHON KOHDEN			Clip,TPU,3 Ld,No Resistance,AHA	EA055C3A	C4
			Clip,TPU,3 Ld,No Resistance,IEC	EA055S3I	C4
			Clip,TPU,5 Ld,No Resistance,AHA	EA055C5A	C6
			Clip,TPU,5 Ld,No Resistance,IEC	EA055S5I	C6
<b>Compatible Philips</b>					
Defibrillator, Agilent, Envisor, IntelliVue, MP20/30/50, IE33, IE33, 43100A, 43120A, 78352C, M1001A, M1165A, M1204A, Transport, M1722A/B, M2601A, M3000A, V24E, Agilent 50XM Fetal Monitor; Newtech NT3A			Snap,TPU,5 Ld,1KQ,AHA	EA023S5A	C9
			Snap,TPU,5 Ld,1KQ,IEC	EA023S5I	C9
			Snap,TPU,3 Ld,1KQ,AHA	EA023S3A	C7
			Snap,TPU,3 Ld,1KQ,IEC	EA023S3I	C7
			Clip,TPU,3 Ld,1KQ,AHA	EA023C3A	C8
			Clip,TPU,3 Ld,1KQ,IEC	EA023C3I	C8
			Clip,TPU,3 Ld,1KQ,IEC	EA023A3I	C8
			Clip,TPU,5 Ld,1KQ,AHA	EA023C5A	C0
			Clip,TPU,5 Ld,1KQ,IEC	EA023C5I	C0

OEM Manufacturer & Models	Connector	OEM #	Descriptions	Order Code	price
<b>Compatible Philips</b>					
Codemaster XL/100, 43100A, MC Defibrillator, 43200A Portable, M3500B, 77000AC, Sonos/AC/AR, 77025A, M1722A/B, Sonos 2000/2500, M2425A, M2475B			Clip,TPU,5 Ld,1KQ,IEC	EA035C5I	D0
			Snap,TPU,3 Ld,1KQ,AHA	EA035S3A	D7
			Snap,TPU,3 Ld,1KQ,IEC	EA035S3I	D7
			Clip,TPU,3 Ld,1KQ,IEC	EA035C3I	D8
			Snap,TPU,5 Ld,1KQ,AHA	EA035S5A	D9
			Snap,TPU,5 Ld,1KQ,IEC	EA035S5I	D9
			Clip,TPU,6 Ld,1KQ,IEC	EA035C6I	D5
<b>Compatible Petas (Turkey)</b>					
KMA160R, 165R, 260R, K-250, 300...			Clip,TPU,4LD,No Resistance,IEC	EA063C3IH	B0
<b>Compatible Saadat</b>					
			Clip,TPU,3 Ld,1KQ,IEC	EA083C3I	D5
			Clip,TPU,5 Ld,1KQ,IEC	EA083C5I	D5
			Snap,TPU,3 Ld,1KQ,IEC	EA083S3I	D5
			Snap,TPU,3 Ld,1KQ,IEC	EA083P3I	D5
<b>Compatible Creative, Spurt, See Biolight</b>					
<b>Compatible S&amp;W (Artema)</b>					
8000, Diascope 1, Diascope 2, Diascope NT, Diascope 2010, AtheN/A			Clip, TPU, 3 Ld, No Resistance, IEC	EA018C3I	C0
<b>Compatible Schiller</b>					
SHILLER ARGUS LCM+			Clip, TPU, 5 Ld, 1KΩ, IEC	EA082C5I	D0
<b>Compatible Spacelabs</b>					
90496 Ultraview, 90369 Ultraview, 90367 Ultraview			Snap,TPU,5Ld,1KQ,AHA	EA009S5A	C9
			Clip,TPU,3 Ld,1KQ,AHA	EA009C3A	C8
			Clip,TPU,3 Ld,1KQ,IEC	EA009C3I	C8
			Snap,TPU,3 Ld,1KQ,IEC	EA009S3I	C7
			Clip,TPU,5 Ld,1KQ,AHA	EA009C5A	C0
			Clip,TPU,5 Ld,1KQ,IEC	EA009C5I	C0







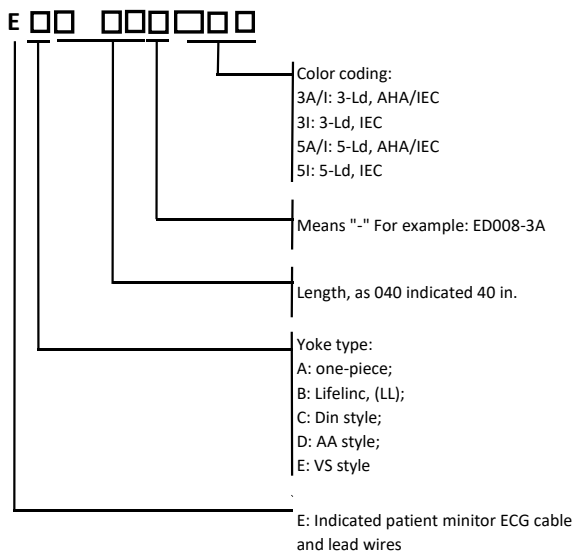





## 4 ECG Trunk Cables















### Type Designation

















### Product Features

1. Easy to replace leadwires;
2. Meeting the requirements of EC53;
3. Flexible and durable cables, enduring repeated cleaning and disinfection;
4. Outstanding shielding property and anti-interference performance, protecting ECG signal from being interfered;
5. Excellent defibrillation-proof performance, protecting the equipment well;
6. ESU-proof, ensuring ECG signals not interfered during operation;
7. Latex free.













OEM Manufacturer & Models	Connector	Yoke (Leads Side)	OEM #	Order Code	Descriptions	price
<b>Compatible Biolight (China)</b>						
AnyView A2, AnyView A3,AnyView A5, AnyView A6,AnyView A8, AnyView Q3, AnyView Q5, AnyView Q7, AnyView V				EC417-3AI	3LD,9ft (2.7m),AHA/IEC, No Resistance , fit for Din Style LeadWires	C2
				EC417-5AI	5LD,9ft (2.7m),AHA/IEC, No Resistance, fit for Din Style LeadWires	C4
<b>Compatible Bionet (Korea)</b>						
BM3				EB041-3AI	3LD,9ft (2.7m),AHA/IEC,1KΩ, fit for LL Style LeadWires	C2
BM5, BM7 <b>NEW</b>				ED400-3A	3LD,9ft (2.7m),AHA,1KΩ, fit for AA Style LeadWires	C2
				ED400-5A	5LD,9ft (2.7m),AHA,1KΩ, fit for AA Style LeadWires	C4
				ED400-5I	5LD,9ft (2.7m),IEC,1KΩ, fit for AA Style LeadWires	C4
<b>Compatible Colin (Omron)</b>						
BP88S				EM061-5I	5Ld, 9ft (2.7m), IEC, No Resistance, fit for Colin LeadWires	E0
<b>Compatible Creative (China)</b>						
PC9000S, PC9000, UP6000				EC046-3AI	3Ld, 9ft (2.7m), AHA/IEC, No Resistance, fit for Din style	C3
<b>Compatible Comen (China)</b>						
Comen: C20, C21, C30, C50, C70, C90, C100, C100A, NC3, NC5, NC8, NC10, NC12, NC19			040-000413-00	EC414-3AI	3LD, 11.8ft (3.6m), AHA/IEC, No Resistance, fit for Comen LeadWires	C3
				EC414-5AI	5LD, 11.8ft (3.6m), AHA/IEC, No Resistance, fit for Comen LeadWires	C5
<b>Compatible Drager/Siemens</b>						
UM1/3/3.1, RM1, PM8010,PM8014, Babyguard8000, Cato, PB8800, Series 8000, Cicero, Parameterbox				EC057-3AI	3Ld, 9ft (2.7m), AHA/IEC, No Resistance, fit for Din style LeadWires	D0

OEM Manufacturer & Models	Connector	Yoke (Leads Side)	OEM #	Order Code	Descriptions	price
<b>Compatible Datascope</b>						
2000, 2001, 2002, 2100, 2200,3000, 3000A, Ballon Pump,M/D3 w/lead select, M/D3A,M/D4, Passport, Passport IL,Passport XG, Passport XL,Passport 2, Passport 2LT,Spectrum System 90, System 90T, System 96, System 97			0010-30-12377	EC002-3AI	3Ld,9ft (2.7m),AHA/IEC, No Resistance fit for Din style LeadWires	B9
			0012-00-1255-01, 0010-30-42782	EC002-5AI	5Ld,9ft (2.7m),AHA/IEC, No Resistance, fit for Din style LeadWires	B0
<b>Compatible Din Style Normal</b>						
AAMI: ALL BCI Covidien Datex: Draeger: GE: 8700 Series Medtronic: Lifepak Mindray: Nihon Kohden Philips Spacelabs Welch Allyn Zoll			Covidien:13 40PS	EC020-3AI	3Ld,9ft (2.7m),AHA/IEC, No Resistance, fit for Din style LeadWires	B9
			Spacelabs: 012-0107-01	EC020-5AI	5Ld,9ft (2.7m),AHA/IEC, No Resistance , fit for Din style LeadWires	B0
			Covidien:13 40PS	EC021-3AI	3Ld,9ft (2.7m),AHA/IEC,1KΩ, fit for Din style LeadWires	C2
			Datascope: 0012-00-0620-01	EC021-5AI	5Ld,9ft (2.7m),AHA/IEC,1KΩ, fit for Din style LeadWires	C5
<b>Compatible Datex</b>						
AS/3, CS/3, S/5, Cardiocap 1, Cardiocap 2, Cardiocap 5, Light Monitor, Satliteplus			545307-HEL 545302-HEL	EB010-3AI	3Ld,9ft (2.7m),AHA/IEC No Resistance, fit for LL style LeadWires	C8
			545303-HEL M1020563	EB010-5AI	5Ld,9ft (2.7m),AHA/IEC, No Resistance, fit for LL style LeadWires	C0
Datex-Ohmeda Patient monitor				EH010-3AI	3Ld,9ft (2.7m), AHA/IEC,4.7KΩ, fit for ASP style LeadWires	D1
				EH010-5AI	5Ld,9ft (2.7m), AHA/IEC,4.7KΩ, fit for ASP style LeadWires	D2

OEM Manufacturer & Models	Connector	Yoke (Leads Side)	OEM #	Order Code	Descriptions	price
<b>Compatible Drager</b>						
Drager Gamma/Gamma XL/ Gamma X XL Delta/Delta XL Kappa/Kappa XLT Vista/Vista XL			MS20094	EQ091-6AI	Multiparameter cable MultiMed@plus OR, for 6-lead ECG, resp., SpO2, and temp., 8.2ft (2.5m), 1KΩ	O0
			MS16256	EQ080-6AI	ECG extension Cables, 2M	D0
Drager (Drager Infinity 6000 / 7000 / 9000 Gamma/Gamma XL/ Gamma X XL Delta/Delta XL Kappa/Kappa XLT Vista/Vista XL			3368391	EQ056-5AI	Multiparameter cable MultiMed@5 Pod, for 5-lead ECG, resp., SpO2, and temp., 8.2ft (2.5m), 1KΩ	M0
			5950196	EQ057-5AI	Multiparameter cable MultiMed8 5 Pod, for 5-lead ECG, resp., SpO2, and temp., 4.9ft (1.5m)	M0
<b>Compatible Emtel</b>						
Emtel: Fx 2000				EC092-3AI	3Ld, 9ft (2.7m), AHA/IEC, 1KΩ, fit for Din style LeadWires	D8
				EC094-3A	3Ld, 9ft (2.7m), AHA/IEC, 1KΩ, fit for Din style LeadWires	D0
<b>Compatible Fukuda Denshi</b>						
FUKUDA: Dynascope DS-7100				EJ032-5AI	5Ld, 9ft (2.7m), AHA/IEC, 10kΩ, fit for Euro style LeadWires	D5
				<b>NEW</b> EJ032-3AI	3Ld, 9ft (2.7m), AHA/IEC, 10kΩ, fit for Euro style LeadWires	D5
FUKUDA				<b>NEW</b> EC401-3I	3Ld, 9.2ft (2.8m), IEC, No Resistance, fit for Euro style LeadWires	D5
				<b>NEW</b> ED401-3A-U	3Ld, 9ft (2.7m), AHA, No Resistance, fit for Euro style LeadWires	D5
				ED401-5A	5Ld, 9ft (2.7m), AHA, No Resistance, fit for Euro style LeadWires	D5

OEM Manufacturer & Models	Connector	Yoke (Leads Side)	OEM #	Order Code	Descriptions	price
<b>Compatible Fukuda Denshi</b>						
				VJ032-EAI	87in.(2.2m),10kΩ Res.+discharge AAMI/IEC,Fit Euro type leadwires As EJ040S5A andVJ040S5A	E0
Fukuda Denshi DYNASCOPE DS-8500 CIO- 05CTP-10NU				VJ200-EAI	87in.(2.2m),No resistance AHA/IEC,fit for Euro style Lead Wires.As EJ040S5A and VJ040S5A	O0
<b>Compatible Goldway (China)</b>						
Goldway: UT4000 Series UT6000F, UT4000Fpro, UT4800				EB002-3AI	3Ld,9ft (2.7m), No resistance,AHA/IEC, fit for LL style LeadWires	B9
				EB002-5AI	5Ld,9ft (2.7m), No resistance,AHA/IEC fit for LL style LeadWires	B0
<b>Compatible GE</b>						
Marquette: GEMS: Dash PRO Series, Eagle Systems, MAC-Lab, Solar, Tram Series, Unity Systems			2022948-001	EE007-5AI	5Ld,9ft (2.7m),AHA/IEC, No resistance fit for VS style LeadWires	C5
			2106307-001	EE007-6AI	6Ld,11.8ft (3.6m),AHA/IEC, No resistance, fit for VS style LeadWires	C6
Marquette: Pro1000				EH021-3A	3Ld,9ft (2.7m),AHA/IEC,1KΩ, fit for ASP style LeadWires	D4
				EH021-5AI	5Ld,9ft (2.7m),AHA/IEC,1KΩ, fit for ASP style LeadWires	D5
GE-Marquette: For GE Eagle, Solar, Dash, Tram, MAC-Lab Cath Lab System, Datex- Ohmeda S/5 FM			(AAMI: E9002ZH, 416035- 001) (IEC: E9002ZJ, 416035- 002)	VE006-BAI	2.2m,1KΩ,resistance, AAMI/IEC ,fit for Multi-link (VS)style Lead Wires AS EE051S5I and EW051S5I-G	D6

OEM Manufacturer & Models	Connector	Yoke (Leads Side)	OEM #	Order Code	Descriptions	price
<b>Compatible Hellige</b>						
Cardioserv Eagle 1000/3000;				EE011-5AI	5Ld,9ft (2.7m),AHA/IEC, 10KΩ,fit for VS style LeadWires	D6
Hellige,Servomed 4 Generation, SCP 851, SCP 852, SCP 844, SCS 804, VICOM-sm; Hellige,Servomed 4Generation, SCP 851,SCP 852, SCP 844,SCS 804, CardioServ VICOM-sm;				EB011-5AI	5Ld,9ft (2.7m),AHA/IEC, No resistance, fit for LL style LeadWires	C0
				EH011-3AI	3Ld,9ft (2.7m),AHA/IEC, 1KΩ,fit for ASP style LeadWires	D4
<b>Compatible Huntleigh Healthcare</b>						
UK MONITOR				EC047-3AI	3Ld, 9ft (2.7m), AHA/IEC,No resistance,fit for Din style LeadWires	B0
<b>Compatible Lifelinc (LL) Style Normal</b>						
LIFE SCIENCE INSTRUMENTS (LSI): LS5, 261, MEDICAL DATA electronics (MDE):Escort 100, Escort 101, Escort 102 , Escort 200,Escort 300, Prism, 360SL, 450SL, 521A,PortaPak 80, PortaPak 90, PortaPak 1000				EB020-3AI	3Ld, 9ft (2.7m), AHA/IEC, No resistance, fit for LL style LeadWires	B9
				EB020-5AI	5Ld, 9ft (2.7m), AHA/IEC, No resistance, fit for LL style LeadWires	B0
<b>Compatible Mindray (China)</b>						
Mindray: PM7000/8000 /9000; Creative: UT4000				EJ085-3AI	3Ld, 9ft (2.7m), AHA/IEC, 1KΩ, fit for Euro style LeadWires	C1
				EJ085-5AI	5Ld, 9ft (2.7m), AHA/IEC, 1KΩ, fit for Euro style LeadWires	C2

OEM Manufacturer & Models	Connector	Yoke (Leads Side)	OEM #	Order Code	Descriptions	price
<b>Compatible Mindray (China)</b>						
PM-6000 after 2004			0010-30-12378	EJ021-3AI	3Ld,9ft (2.7m),AHA/IEC,1KΩ, fit for Euro style LeadWires	C1
			0010-30-12257	EJ021-5AI	5Ld,9ft(2.7m)AHA/IEC,1 KΩ fit for Euro style LeadWires	C2
PM6000,T8			0010-30-12379	EJ050-3AI	3Ld,9ft (2.7m),AHA/IEC,1KΩ, fit for Euro style LeadWires	C5
			0010-30-12260	EJ050-5AI	5Ld,9ft (2.7m),AHA/IEC,1KΩ, fit for Euro style LeadWires	C6
PM-6800, PM-6000 after 2004, BeneView (T5, T6, T8), iPM Series; (Beneheart D6, BeneView T1, T5, T8, DPM 6,7, iPM-9800, MEC 1000, MPM, Passport 12, Passport 8, PM5000, PM6000, T8)			0010-30-42724	EJ051-3AI	3Ld,9ft (2.7m),AHA/IEC,1KΩ, fit for Euro style LeadWires ESU-Proof	D0
			0010-30-42723	EJ051-5AI	5Ld,9ft (2.7m),AHA/IEC,1KΩ, fit for Euro style LeadWires ESU-Proof	E1
			0010-30-42719	EJ050-3AI	3Ld,9ft (2.7m),AHA/IEC,1KΩ, fit for Din style LeadWires	C0
Datascope passport V, V12, V21			0012-00-1745-01	FR090-3A	3Ld,10.5ft (3.2m),AHA/IEC,1KΩ, fit for Mindray 3 Leadwires	D5
			0012-00-1745-01	ER090-5AI	5Ld,10.5ft (3.2m),AHA/IEC,1KΩ, fit for Mindray 5 Leadwires	E2

OEM Manufacturer & Models	Connector	Yoke (Leads Side)	OEM #	Order Code	Descriptions	price
<b>Compatible Mindray (China)</b>						
PM-7000/ PM9000Super/ PM-9000Express (12 LEAD ECG MODULE), View Oem p/n:0010-30- 42721 (AAMI ) Oem p/n: DPM6, DPM7, Passport 12m, Passport 17m, T1			0010-30- 42721	VE020-BAI	2.2m, 1kΩ resistance, AAMI/IEC, fit for Multi- link(VS) style Lead Wires AS VE008BNI and VE008CNA	D5
<b>Compatible Nihon Kohden</b>						
OEC-6102A (s/n<20156), OEC-6105A (s/n<20226), OEC-6120A/J/K BSM-7105K				EC037-3AI	3Ld,9ft (2.7m),AHA/IEC,1kΩ, fit for Din style LeadWires	C0
			JC-005P	EN037-3I	3Ld,9ft (2.7m),IEC,No resistance,fit for BR-019 LeadWires	D5
BSM-2301, BSM- 2353, BSM-5100, Multi- parameter bedside monitors BSM-73			JC-906P	EP055-6I	6Ld,9ft (2.7m),IEC, No resistance, fit for BR-903P, BR-906P	E5
				EC055-3AI	3-Ld,9ft (2.7m), No resistance,AHA/IEC, fit for Din Style LeadWires	C0
OPV-1500 Lifescope N BSM-73			L060JC- 103T	EP080-3I	3Ld,9ft (2.7m)IEC,47KΩ,fit for BR-903P,BR-906P	E0
BSM-7102A,OMP- 7201C, OMP-7203C, TEC-5200A (s/n<20421)				EC038-3AI	3Ld,9ft (2.7m),AHA/IEC,No resistance,fit for Din style LeadWires	D5
				ENO38-3I	3Ld,9ft (2.7m),IEC,No resistance,fit for BR-019 LeadWires	D5

OEM Manufacturer & Models	Connector	Yoke (Leads Side)	OEM #	Order Code	Descriptions	price
<b>Compatible Philips</b>						
8-Pin Connector: 78208A, 78210A, 78330A, 78331A, 78332A, 78333A, 78341A, 78342A, 78345A, 78346A, 78351T, 78352A, 78353A, 78354A, 78532A/B, 78534A/B/C, M1722A/B, M3500B				ED035-5A	5Ld,9ft (2.7m),AHA,1KΩ, fit for AA style LeadWires	D4
			M1600A	ED035-5I	5Ld,9ft (2.7m),IEC,1KΩ, fit for AA style LeadWires	D4
			M1610A	ED035-3A	3Ld,9ft (2.7m),AHA,1KΩ, fit for AA style LeadWires	C0
			M1580A	ED035-3I	3Ld,9ft (2.7m) IEC,1KΩ, fit for AA style LeadWires	C0
78834C 78850A			M1590	ED036-3A	3Ld,9ft (2.7m),AHA,1KΩ, fit for AA style LeadWires	C0
			M1620A	ED036-3I	3Ld,9ft (2.7m),IEC,1KΩ, fit for AA style LeadWires	C0
78352C, 78354C, 78834C, HeartStart MRx, IntelliVue, IntelliVue MP2, IntelliVue MP5, M1001A,M1001B, M1002A,M1002B, M3001A,M8102A, M8105A, MMS X2			M1663A, M1949A(2.7 m) M3525A, 989803125 831 (2.7m), 989803144 791	VDG023-AAI	8.9ft (2.7m),AAMI/IEC,1KΩ,fit for Philips style Lead Wires AS VDG040CNA or VDG040SNI	E5
M3000A, M3001A, M1001A/B, M1002A/B, 78352C, 78354C			M1669A	EDG073-3AI	3Ld,9ft (2.7m),IEC/AAMI,1KΩ, fit for Philips LeadWires	D9
			M1668A	EDG073-5AI	5Ld,9ft (2.7m),IEC/AAMI,1KΩ, fit for Philips LeadWires	E5
			989803170 171	EDG073-3AI-OR	3Ld,9ft (2.7m),IEC/AAMI, 1KΩ,Used with EDG040C3A-OR/EDG040C3I-OR	E0
			989803170 181	EDG073-5AI-OR	5Ld,9ft (2.7m),IEC/AAMI, 1KΩ,Used with EDG040C5A-OR/EDG040C5I-OR	E0

OEM Manufacturer & Models	Connector	Yoke (Leads Side)	OEM #	Order Code	Descriptions	price
<b>Compatible Philips</b>						
78352C, 7834C, 78834C, M1001A/B, M1002A/B, M1722A/B, M1723A/B, M2475B, M3000A, M3001A, M4735A, VM4/V24			M1500A	ED023-3A	3Ld,9ft (2.7m),AHA,1KΩ, fit for AA style LeadWires	C0
			M1510A	ED023-3I	3Ld,9ft (2.7m),IEC,1KΩ, fit for AA style LeadWires	C0
			M1520A	ED023-5A	5Ld,9ft (2.7m),AHA,1KΩ, fit for AA style LeadWires	D4
			M1530A	ED023-5I	5Ld,9ft (2.7m),IEC,1KΩ, fit for AA style LeadWires	D4
<b>Philips ECG Leadwires Set</b>						
Patient Monitor				ED021-5AI	5Ld,9ft(2.7m),AHA/IEC,1 KΩ, fit for AA styleLeadWires	D4
				ED021-3AI	3Ld,9ft(2.7m),AHA/IEC,1 KΩ, fit for AA styleLeadWires	D4
<b>Compatible Spacelabs</b>						
90496 Ultraview, 90369 Ultraview, 90367 Ultraview			IEC: 700-0008-07 AHA: 700-0008-06	EL009-5AI	5Ld,9ft (2.7m),AHA/IEC,1KΩ, fit for TRU-LINK LeadWires	C9
				EE009-5AI	5Ld,9ft (2.7m),AHA/IEC,1KΩ, fit for VS style LeadWires	C9
				EJ009-3AI	3Ld,9ft (2.7m),AHA/IEC,1KΩ, fit for Euro style LeadWires	C7
				EJ009-5AI	5Ld,9ft (2.7m),AHA/IEC,1KΩ, fit for EURO style leads	C9
TRU-LINK Accessories for 90496 Module			700-0008-01	VE027-BAII	2.2m,1KΩ resistance, AAMI/IEC fit for Multi-link (VS) style Lead Wires AS VE008BNI,VE008CNA	D5

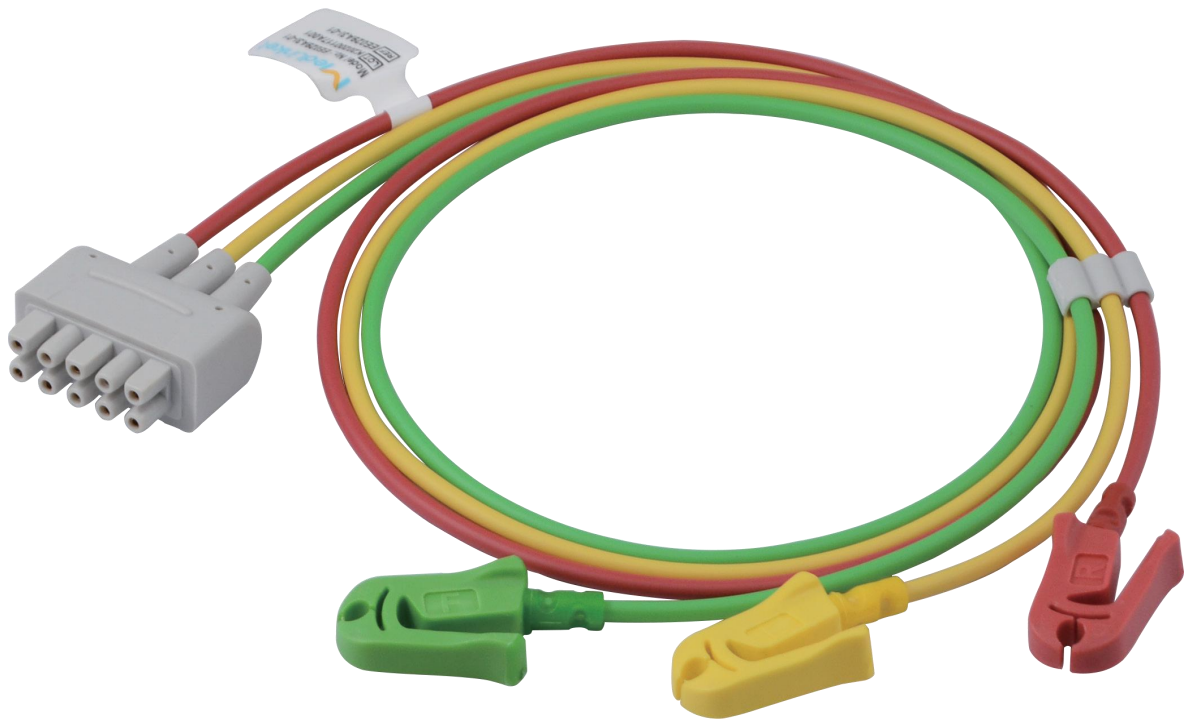



## 5 ECG Leadwires

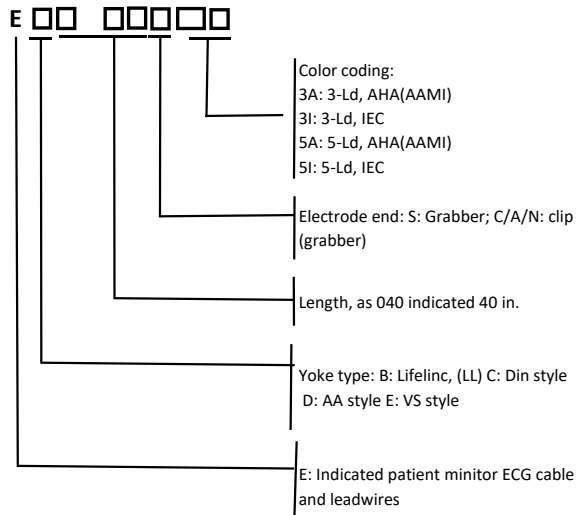

### Type Designation



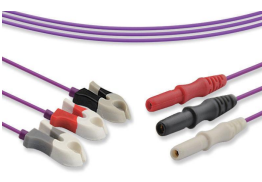





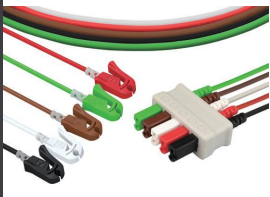

### Product Features

1. For adult, pediatric and neonate patients;
2. Meeting the requirements of EC53;
3. Integrated two-color molding with flexibility, seamless connection and dustproof design;
4. Flexible and durable cables, enduring repeated cleaning and disinfection;
5. Outstanding shielding property and anti-interference performance, protecting ECG signal from being interfered;
6. Use different color cable to indicate the corresponding use lead wires position, easy to identify and operate;
7. Latex free.



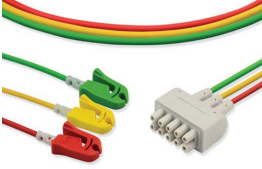

Picture	OEM #	Descriptions	Order Code	price	
<b>Din Type ECG Leadwires Set</b>					
 <p>EC024N3A</p>		24in.(61cm),3-Ld,Neonatal Grabber (Clip), No Resistance,AHA	EC024N3A	B5	
		24in.(61cm),3-Ld,Neonatal Grabber (Clip), No Resistance,IEC	EC024N3I	B5	
		18in.(45cm),3-Ld,Snap,No Resistance,AHA	EC018S3A	B9	
		18in.(45cm),3-Ld,Snap,No Resistance,IEC	EC018S3I	B9	
		18in.(45cm),3-Ld,Mini Grabber(Clip), No Resistance,AHA	EC018C3A	B9	
		18in.(45cm),3-Ld,Mini Grabber (Clip), No Resistance,IEC	EC018C3I	B9	
		24in.(61cm),3-Ld,Mini Snap,No Resistance,AHA	EC024S3A	A6	
		24in.(61cm),3-Ld,Mini Snap,No Resistance,IEC	EC024S3I	A6	
		24in.(61cm),3-Ld,Mini Grabber (Clip), No Resistance,AHA	EC024C3A	A7	
		24in.(61cm),3-Ld,Mini Grabber (Clip), No Resistance,IEC	EC024C3I	A7	
	 <p>EC040C3A</p>		39in.(100cm),3-Ld,Mini Snap,No Resistance,AHA	EC040S3A	A6
			39in.(100cm),3-Ld,Mini Snap,No Resistance,IEC	EC040S3I	A6
			39in.(100cm),3-Ld,Mini Grabber (Clip), No Resistance,AHA	EC040C3A	A7
			39in.(100cm),3-Ld,Mini Grabber (Clip), No Resistance,IEC	EC040C3I	A7
<b>Colin Type ECG Leadwires Set</b>					
 <p>EM040S3I</p>			39in.(100cm),3-Ld,Snap, No Resistance,AHA/IEC	EM040S3A	B7
		39in.(100cm),3-Ld,Snap, No Resistance,AHA/IEC	EM040S3I	B7	
		39in.(100cm),3-Ld,Grabber(Clip), No Resistance AHA/IEC	EM040C3A	B8	
		39in.(100cm),3-Ld,Grabber (Clip), No Resistance, AHA/IEC	EM040C3I	B8	
		39in.(100cm),5-Ld,Snap, No Resistance,AHA/IEC	EM040S5A	C5	
		39in.(100cm),5-Ld,Snap, No Resistance,AHA/IEC	EM040S5I	C5	
		39in.(100cm),5-Ld,Grabber (Clip), No Resistance,AHA/IEC	EM040C5A	C6	
		39in.(100cm),5-Ld,Grabber(Clip), No ResistanceAHA/IEC	EM040C5I	C6	

Picture	OEM #	Descriptions	Order Code	price	
<b>Conmed Type ECG Leadwires Set</b>					
 <p>EG040S5A</p>		35in.(90cm),3-Ld,Snap,No Resistance,AHA	EG040S3A	B0	
		35in.(90cm),3-Ld,Snap,No Resistance,IEC	EG040S3I	B0	
		35in.(90cm),3-Ld,Grabber (Clip), No Resistance,AHA	EG040C3A	C1	
		35in.(90cm),3-Ld,Grabber (Clip), No Resistance,IEC	EG040C3I	C1	
		35in.(90cm),5-Ld,Snap,No Resistance,AHA	EG040S5A	C2	
		35in.(90cm),5-Ld,Snap,No Resistance,IEC	EG040S5I	C2	
		35in.(90cm),5-Ld,Grabber (Clip), No Resistance,AHA	EG040C5A	C3	
		35in.(90cm),5-Ld,Grabber (Clip), No Resistance,IEC	EG040C5I	C3	
<b>Drager-Siemens Single-Pin Type ECG Leadwires Set</b>					
 <p>EQ040S3I</p>  <p>EQ040C3I</p>		35in.(90cm),3-Ld,Snap,No Resistance,AHA	EQ040S3A	C5	
		35in.(90cm),3-Ld,Snap,No Resistance,IEC	EQ040S3I	C5	
	MP03402/MP03422 MP03401/MP03421		35in.(90cm),3-Ld,Grabber (Clip),No Resistance,AHA	EQ040C3A	C5
			35in.(90cm),3-Ld,Grabber (Clip),No Resistance,IEC	EQ040C3I	C5
		35in.(90cm),5-Ld,Snap,No Resistance,AHA	EQ040S5A	C5	
		35in.(90cm),5-Ld,Snap,No Resistance,IEC	EQ040S5I	C5	
	MP03404/MP03424 MP03403/MP03423		35in.(90cm),5-Ld,Grabber (Clip),No Resistance,AHA	EQ040C5A	C5
			35in.(90cm),5-Ld,Grabber (Clip),No Resistance,IEC	EQ040C5I	C5
		35in.(90cm),6-Ld,Snap,No Resistance,AHA	EQ040S6A	C0	
		35in.(90cm),6-Ld,Snap,No Resistance,IEC	EQ040S6I	C0	
		35in.(90cm),6-Ld,Grabber (Clip),No Resistance,AHA	EQ040C6A	C0	
		35in.(90cm),6-Ld,Grabber (Clip),No Resistance,IEC	EQ040C6I	C0	
	MP03406/MP03426 MP03405/MP03425		OR,35in.(90cm),3-Ld,Grabber (Clip), 10KQ,AHA	EQ040C3A-OR	C5
			OR,35in.(90cm),3-Ld,Grabber (Clip),10KQ,IEC	EQ040C3I-OR	C5
		36in(92cm),5-Ld,Snap,No Resistance,AHA	EQ035S5A	C5	
		36in(92cm),5-Ld,Snap,No Resistance,IEC	EQ035S5I	C5	
	36in(92cm),6-Ld,Snap,No Resistance,AHA	EQ-096P6A	C0		
	36in(92cm),6-Ld,Snap,No Resistance,IEC	EQ-096P6I	C0		

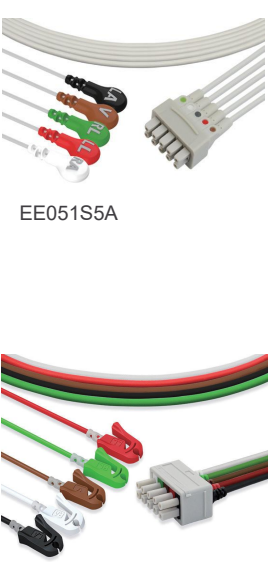
Picture	OEM #	Descriptions	Order Code	price	
<b>Drager-Siemens Dual-Pin Type ECG Leadwires Set</b>					
 <p>EJ074C5A</p>		35in.(90cm),3-Ld,Snap,No Resistance,AHA	EJ074S3A	C1	
		35in.(90cm),3-Ld,Snap,No Resistance,IEC	EJ074S3I	C1	
	MP03412 MP03411	35in.(90cm),3-Ld,Grabber (Clip), No Resistance,AHA	EJ074C3A	C1	
		35in.(90cm),3-Ld,Grabber (Clip), No Resistance,IEC	EJ074C3I	C1	
		35in.(90cm),5-Ld,Snap,No Resistance,AHA	EJ074S5A	C2	
		35in.(90cm),5-Ld,Snap,No Resistance,IEC	EJ074S5I	C2	
	MP03414 MP03413	35in.(90cm),5-Ld,Grabber(Clip), No Resistance,AHA	EJ074C5A	C2	
		35in.(90cm),5-Ld,Grabber (Clip), No Resistance,IEC	EJ074C5I	C2	
		36in(92cm),3-Ld,Clip,No Resistance,AHA,Infant	EJB035N3A	C0	
		36in(92cm),3-Ld,Clip,No Resistance,IEC,Infant	EJB035N3I	C0	
	<b>GE Datex Ohmeda ASP Type ECG Leadwires Set</b>				
	 <p>EH040C3A</p>	545327-HEL(75cm) 107328(150cm)	39in.(100cm),3-Ld,Snap,No Resistance,AHA	EH040S3A	B8
39in.(100cm),3-Ld,Snap,No Resistance,IEC			EH040S3I	B8	
545317-HEL(75cm) 8001958(150cm)		39in.(100cm),3-Ld,Grabber (Clip), No Resistance,AHA	EH040C3A	B8	
		39in.(100cm),3-Ld,Grabber (Clip), No Resistance,IEC	EH040C3I	B8	
545317-HEL(75cm) 8001958(150cm)		24in.(61cm),3-Ld,Grabber (Clip), No Resistance,AHA	EH024C3A	B8	
		24in.(61cm),3-Ld,Grabber (Clip), No Resistance,IEC	EH024C3I	B8	
545328		39in.(100cm),5-Ld,Snap,No Resistance,AHA	EH040S5A	C1	
		39in.(100cm),5-Ld,Snap,No Resistance,IEC	EH040S5I	C1	
545318(Mixed) 8001959-HEL,545326		39in.(100cm),5-Ld,Grabber (Clip), No Resistance,AHA	EH040C5A	C1	
		39in.(100cm),5-Ld,Grabber (Clip), No Resistance,IEC	EH040C5I	C1	
<b>GE CARESCAPE ONE Mini ECG Lead Wires</b>					
			29in.(74cm),4-Ld,Grabber (Clip),No Resistance,AHA	EV029C4A	C5
		29in.(74cm),4-Ld,Grabber (Clip),No Resistance,IEC	EV029C4I	C5	
<b>GE Multi-link type ECG Leadwires Set</b>					
	2106394-003	51in.(130cm),5-Ld,Non-Molded,Snap,Chest, No Resistance,AHA	EW051S5A	C2	
		51in.(130cm),5-Ld,Non-Molded,Snap,Chest, No Resistance,IEC	EW051S5I	C2	
	2106394-003	51in.(130cm),5-Ld,Non-Molded,Grabber (Clip), Chest,No Resistance,AHA	EW051C5A	C2	
		51in.(130cm),5-Ld,Non-Molded,Grabber (Clip), Chest,No Resistance,IEC	EW051C5I	C2	

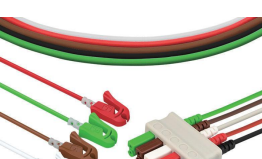

Picture	OEM #	Descriptions	Order Code	price
<b>GE Multi-link type ECG Leadwires Set</b>				
		29in.(75cm),3-Ld,Non-Molded,Snap, No Resistance,AHA	EE029S3A	C1
		29in.(75cm),3-Ld,Non-Molded,Snap, No Resistance,IEC	EE029S3I	C1
EE029C3A-	2106385-001	29in.(75cm),3-Ld,Molded,Snap, No Resistance,AHA	EE029S3A-G	C1
		29in.(75cm),3-Ld,Molded,Snap No Resistance,IEC	EE029S3I-G	C1
	411203-001 411203-003	29in.(75cm),3-Ld,Non-Molded,Grabber(Clip), No Resistance,AHA	EE029C3A	C1
		29in.(75cm),3-Ld,Non-Molded,Grabber(Clip), No Resistance,IEC	EE029C3I	C1
EE029C3I-G	2106381-001	29in.(75cm),3-Ld,Molded,Grabber(Clip), No Resistance,AHA	EE029C3A-G	C1
		29in.(75cm),3-Ld,Molded,Grabber(Clip), No Resistance,IEC	EE029C3I-G	C1
	411202-001 411202-003	29in.(75cm),5-Ld,Non-Molded,Snap, No Resistance,AHA	EE029S5A	C2
		29in.(75cm),5-Ld,Non-Molded,Snap, No Resistance,IEC	EE029S5I	C2
EE029S5A-G	2106391-001	29in.(75cm),5-Ld,Molded,Snap, No Resistance,AHA	EE029S5A-G	C2
		29in.(75cm),5-Ld,Molded,Snap, No Resistance,IEC	EE029S5I-G	C2
	412681-001 412681-003	29in.(75cm),5-Ld,Non-Molded,Grabber(Clip), No Resistance,AHA	EE029C5A	C2
		29in.(75cm),5-Ld,Non-Molded,Grabber(Clip), No Resistance,IEC	EE029C5I	C2
EE029C5A-G	412681-001 412681-003	29in.(75cm),5-Ld,Molded,Grabber(Clip), No Resistance,AHA	EE029C5A-G	C2
		29in.(75cm),5-Ld,Molded,Grabber (Clip), No Resistance,IEC	EE029C5I-G	C2
	421930-001 421931-001	29in.(75cm),6-Ld,Non-Molded,Snap,Chest, No Resistance,AHA	EE029S6A	C3
		29in.(75cm),6-Ld,Non-Molded,Snap,Chest, No Resistance,IEC	EE029S6I	C3
EE029S6A-G	421932-001 421933-001	29in.(75cm),6-Ld,Non-Molded,Grabber (Clip), Chest,No Resistance,AHA	EE029C6A	C3
		29in.(75cm),6-Ld,Non-Molded,Grabber (Clip), Chest,No Resistance,IEC	EE029C6I	C3
	2106385-002	51in.(130cm),3-Ld,Non-Molded,Snap, No Resistance,AHA	EE051S3A	C1
		51in.(130cm),3-Ld,Non-Molded,Snap, No Resistance,IEC	EE051S3I	C1
EE051S3A-G	411203-002 411203-004	51in.(130cm),3-Ld,Molded,Snap, No Resistance,AHA	EE051S3A-G	C1
		51in.(130cm),3-Ld,Molded,Snap, No Resistance,IEC	EE051S3I-G	C1

Picture	OEM #	Descriptions	Order Code	price
<b>GE Multi-link type ECG Leadwires Set</b>				
 <p>EE051S5A</p> <p>EE051C5A</p>		51in.(130cm),3-Ld,Non-Molded,Grabber (Clip),No Resistance,AHA	EE051C3A	C1
		51in.(130cm),3-Ld,Non-Molded,Grabber (Clip),No Resistance,IEC	EE051C3I	C1
	412682-002 412682-004	51in.(130cm),3-Ld,Molded,Grabber (Clip),No Resistance,AHA	EE051C3A-G	C1
		51in.(130cm),3-Ld,Molded,Grabber (Clip),No Resistance,IEC	EE051C3I-G	C1
	2106381-002	51in.(130cm),5-Ld,Non-Molded,Snap, No Resistance,AHA	EE051S5A	C2
		51in.(130cm),5-Ld,Non-Molded,Snap,No Resistance,IEC	EE051S5I	C2
	411202-002 411202-004	51in.(130cm),5-Ld,Molded,Snap,No Resistance,AHA	EE051S5A-G	C2
		51in.(130cm),5-Ld,Molded,Snap, No Resistance,IEC	EE051S5I-G	C2
	2106391-002	51in.(130cm),5-Ld,Non-Molded,Grabber (Clip),No Resistance,AHA	EE051C5A	C2
		51in.(130cm),5-Ld,Non-Molded,Grabber (Clip),No Resistance,IEC	EE051C5I	C2
	412681-002 412681-004	51in.(130cm),5-Ld,Molded,Grabber (Clip),No Resistance,AHA	EE051C5A-G	C3
		51in.(130cm),5-Ld,Molded,Grabber (Clip),No Resistance,IEC	EE051C5I-G	C3
	2106383-005	Mixed,31.5 in/51.2in,5-Ld,Molded,Snap,No Resistance,AHA/IEC	EE051S5A-GM	C3
		Mixed,31.5 in/51.2in,5-Ld,Molded,Snap,No Resistance,AHA/IEC	EE051S5I-GM	C3
	2106389-005	Mixed,31.5 in/51.2in,5-Ld,Molded,Grabber (Clip),No Resistance,AHA	EE051C5A-GM	C3
		Mixed,31.5 in/51.2in,5-Ld,Molded,Grabber (Clip),No Resistance,IEC	EE051C5I-GM	C3
	2106381-005	Mixed,31.5 in/51.2in,5-Ld,Non-Molded,Snap,No Resistance,AHA	EE051S5A-M	C3
		Mixed,31.5 in/51.2in,5-Ld,Non-Molded,Snap,No Resistance,IEC	EE051S5I-M	C3
	2106391-005	Mixed,31.5 in/51.2in,5-Ld,Non-Molded Grabber (Clip),No Resistance,AHA	EE051C5A-M	C3
		Mixed,31.5 in/51.2in,5-Ld,Non-Molded Grabber (Clip),No Resistance,IEC	EE051C5I-M	C3
		35in.(90cm),3-Ld,Snap,No Resistance,AHA/IEC	EED051P3A	C1
		35in.(90cm),3-Ld,Snap,No Resistance,AHA/IEC	EED051P3I	C1
<b>Compatible: GE-MARQUETTE(E9003CL)</b>				
		19pin to 4pin, 20in.(0.5m), 5-LD, AHA	EE035C3A-G	C1
		19pin to 4pin, 20in.(0.5m), 5-LD, IEC	EE035C3I-G	C1

Picture	OEM #	Descriptions	Order Code	price
<b>GE VS type ECG Leadwires Set</b>				
 EE035C5A-		36in(92cm),5-Ld,Grabber(Clip),No Resistance,AHA	EE035C5A-G	C2
		36in(92cm),5-Ld,Grabber(Clip),No Resistance,IEC	EE035C5I-G	C2
		36in(92cm),3-Ld,Grabber(Clip),No Resistance,AHA	EE035C3A-G	C1
		36in(92cm),3-Ld,Grabber(Clip),No Resistance,IEC	EE035C3I-G	C1
<b>Mindray-Datascope ECG Leadwires Set</b>				
 ER027C5I	0012-00-1503-05	28in.(70cm),3-Ld,Snap,No Resistance,AHA	ER027S3A	C2
		28in.(70cm),3-Ld,Snap,No Resistance,IEC	ER027S3I	C2
	0012-00-1514-05 0012-00-1503-14	28in.(70cm),3-Ld,Grabber (Clip),No Resistance,AHA	ER027C3A	C2
		28in.(70cm),3-Ld,Grabber (Clip),No Resistance,IEC	ER027C3I	C2
 EJ075C5A	0012-00-1503-01	28in.(70cm),5-Ld,Snap,No Resistance,AHA	ER027S5A	C2
		28in.(70cm),5-Ld,Snap,No Resistance,IEC	ER027S5I	C2
	0012-00-1514-02 0012-00-1503-14	28in.(70cm),5-Ld,Grabber (Clip),No Resistance,IEC	ER027C5I	C2
	0010-30-42734	36in.(90cm),3-Ld,Euro,Snap,No Resistance,AHA	EJ075S3A	C1
	0010-30-42733	36in.(90cm),3-Ld,Euro,Snap,No Resistance,IEC	EJ075S3I	C1
	0010-30-42726 0010-30-42725	36in.(90cm),3-Ld,Euro,Grabber (Clip),No Resistance,AHA	EJ075C3A	C1
		36in.(90cm),3-Ld,Euro,Grabber (Clip)No Resistance,IEC	EJ075C3I	C1
	0010-30-42735 0010-30-42736	36in.(90cm),5-Ld,Euro,Snap,No Resistance,AHA	EJ075S5A	C2
		36in.(90cm),5-Ld,Euro,Snap,No Resistance,IEC	EJ075S5I	C2
	0010-30-42727 0010-30-42728	36in.(90cm),5-Ld,Euro,Grabber (Clip),No Resistance,AHA	EJ075C5A	C2
		36in.(90cm),5-Ld,Euro,Grabber (Clip),No Resistance,IEC	EJ075C5I	C2
		36in(0.9m),3-Ld,Clip,No Resistance,AHA,Infant	EJA035N3A	C0
	36in(0.9m),3-Ld,Clip,No Resistance,IEC,Infant	EJA035N3I	C0	
<b>Euro Type ECG Leadwires Set (Code Assemblable)</b>				
 EJ024S5I		24in.(61cm),3-Ld,Snap,No Resistance,AHA	EJ024S3A	B9
		24in.(61cm),3-Ld,Snap,No Resistance,IEC	EJ024S3I	B9
		24in.(61cm),3-Ld,Grabber(Clip),No Resistance,AHA	EJ024C3A	B9
		24in.(61cm),3-Ld,Grabber (Clip),No Resistance,IEC	EJ024C3I	B9
		24in.(61cm),5-Ld,Snap,No Resistance,AHA	EJ024S5A	C1
		24in.(61cm),5-Ld,Snap,No Resistance,IEC	EJ024S5I	C1
<b>Euro Type ECG Leadwires Set (Code Assemblable)</b>				
 EJ040C3I		24in.(61cm),5-Ld,Grabber(Clip),No Resistance,AHA	EJ024C5A	C1
		24in.(61cm),5-Ld,Grabber (Clip),No Resistance,IEC	EJ024C5I	C1
		40in.(102cm),3-Ld,Snap,No Resistance,AHA	EJ040S3A	B8
		40in.(102cm),3-Ld,Snap,No Resistance,IEC	EJ040S3I	B8
		40in.(102cm),3-Ld,Grabber (Clip),No Resistance,AHA	EJ040C3A	B9
		40in.(102cm),3-Ld,Grabber (Clip),No Resistance,IEC	EJ040C3I	B9
<b>Compatible: Instrument:MST600-M8</b>				
		9pin, 40in.(1m), 5-LD, Snap, AHA	EU040S5A	C2

Picture	OEM #	Descriptions	Order Code	price
<b>Euro Type ECG Leadwires Set (Code Assemblable)</b>				
 EJ040S5I		40in.(102cm),5-Ld,Snap,No Resistance,AHA	EJ040S5A	C0
		40in.(102cm),5-Ld,Snap,No Resistance,IEC	EJ040S5I	C0
		40in.(102cm),5-Ld,Grabber (Clip),No Resistance,AHA	EJ040C5A	C1
		40in.(102cm),5-Ld,Grabber (Clip),No Resistance,IEC	EJ040C5I	C1
<b>Nihon Kohden Type ECG Leadwires Set</b>				
 EP035S3I  EP035C3I	BR-913PA BR-913P	35in.(90cm),3-Ld,Snap,No Resistance,AHA	EP035S3A	B8
		35in.(90cm),3-Ld,Snap,No Resistance,IEC	EP035S3I	B8
	BR903PA BR-903P	35in.(90cm),3-Ld,Grabber(Clip),No Resistance,AHA	EN035C3A	B8
		35in.(90cm),3-Ld,Grabber (Clip),No Resistance,IEC	EP035C3I	B8
	BR-916PA BR-916P	35in.(90cm),6-Ld,Snap,No Resistance,AHA	EP035S6A	C7
		35in.(90cm),6-Ld,Snap,No Resistance,IEC	EP035S6I	C7
	BR-906PA BR-906P	35in.(90cm),6-Ld,Grabber (Clip),No Resistance,AHA	EP035C6A	C7
		35in.(90cm),6-Ld,Grabber (Clip),No Resistance,IEC	EP035C6I	C7
	BR-019PA BR-019P	32in.(80cm),3-Ld,Snap,No Resistance,AHA	EN032S3A	B8
		32in.(80cm),3-Ld,Snap,No Resistance,IEC	EN032S3I	B8
	BR-018PA BR-018P	32in.(80cm),3-Ld,Grabber(Clip),No Resistance,AHA	EN032C3A	B8
		32in.(80cm),3-Ld,Grabber (Clip),No Resistance,IEC	EN032C3I	B8
	BR-021PA BR-021P	32in.(80cm),5-Ld,Snap,No Resistance,AHA	EN032S5A	B8
		32in.(80cm),5-Ld,Snap,No Resistance,IEC	EN032S5I	B8
	BR-020PA BR-020P	32in.(80cm),5-Ld,Grabber (Clip),No Resistance,AHA	EN032C5A	B8
		32in.(80cm),5-Ld,Grabber (Clip),No Resistance,IEC	EN032C5I	B8
<b>Philips CBL Type ECG Leadwires Set</b>				
 EDG040C3I  EDG040N5I	M1673A	40in.(102cm),3-Ld,Snap,No Resistance,AHA	EDG040S3A	C5
		40in.(102cm),3-Ld,Snap,No Resistance,IEC	EDG040S3I	C5
	M1671A	40in.(102cm),3-Ld,Grabber (Clip),No Resistance,AHA	EDG040C3A	C5
	M1672A	40in.(102cm),3-Ld,Grabber (Clip),No Resistance,IEC	EDG040C3I	C5
	M1644A	40in.(102cm),5-Ld,Snap,No Resistance,AHA	EDG040S5A	C0
		40in.(102cm),5-Ld,Snap,No Resistance,IEC	EDG040S5I	C0
	M1968A	40in.(102cm),5-Ld,Grabber (Clip),No Resistance,AHA	EDG040C5A	C0
		40in.(102cm),5-Ld,Grabber (Clip),No Resistance,IEC	EDG040C5I	C0
	M1647A/989803145011	Reusable,5 Leads,Mini Grabber clip,AHA,36 Inches	EDG040N5A	C3
	M1648A	Reusable,5 Leads,Mini Grabber clip,IEC,36 Inches	EDG040N5I	C3
	M1624A/989803144941	Reusable,3 Leads,Mini Grabber clip,AHA,36 Inches	EDG040N3A	C3
	M1626A/989803144951	Reusable,3 Leads,Mini Grabber clip,IEC,36 Inches	EDG040N3I	C3





Picture	OEM #	Descriptions	Order Code	price
<b>Philips AA Type ECG Leadwires Set</b>				
 <p>ED040C3I</p>	M1605A	40in.(102cm),3-Ld,Snap,No Resistance,AHA	ED040S3A	B8
		40in.(102cm),3-Ld,Snap,No Resistance,IEC	ED040S3I	B8
	M1603A	40in.(102cm),3-Ld,Grabber (Clip),No Resistance,AHA	ED040C3A	B8
		40in.(102cm),3-Ld,Grabber (Clip),No Resistance,IEC	ED040C3I	B8
	M1625A	39in/61in.(100cm/155cm),5-Ld,Snap,No Resistance,AHA	ED040S5A	C5
		39in/61in.(100cm/155cm),5-Ld,Snap,No Resistance,IEC	ED040S5I	C5
	M1623A	39in/61in.(100cm/155cm),5-Ld,Grabber (Clip),No Resistance,AHA	ED040C5A	C5
		39in/61in.(100cm/155cm),5-Ld,Grabber (Clip),No Resistance,IEC	ED040C5I	C5
		39in.(100cm),3-Ld,Infant,Grabber (Clip)No Resistance,AHA	ED040N3A	C0
		39in.(100cm),3-Ld,Infant,Grabber (Clip),No Resistance,IEC	ED040N3I	C0
<b>Philips Orange Leadwires Set For Operating Room (ESU Protection)</b>				
 <p>EDG040C5A-OR</p>	M1675A M1678A	35in.(90cm),3-Ld,Grabber (Clip),10KQ,AHA	EDG040C3A-OR	E4
		35in.(90cm),3-Ld,Grabber (Clip),10KQ,IEC	EDG040C3I-OR	E4
	M1973A M1974A	36in/61in.(92cm/155cm),5-Ld,Grabber (Clip),10KQ,AHA	EDG040C5A-OR	E0
		36in/61in.(92cm/155cm),5-Ld,Grabber (Clip),10KQ,IEC	EDG040C5I-OR	E0
	M1601A	OR 39in.(100cm),3-Ld,Grabber (Clip),10KQ,AHA	ED040C3A-OR	D1
		OR 39in.(100cm),3-Ld,Grabber (Clip),10KQ,IEC	ED040C3I-OR	D1
	M1621A	OR 39in/61in.(100cm/155cm),5-Ld,Grabber (Clip),10KQ,AHA	ED040C5A-OR	D6
		OR 39in/61in.(100cm/155cm),5-Ld,Grabber (Clip),10KQ,IEC	ED040C5I-OR	D6
<b>Spacelabs TRU-Link Type ECG Leadwires Set</b>				
 <p>EL024S3A</p>	700-0007-00 700-0007-01	23in.(60cm),3-Ld,Snap,No Resistance,AHA	EL024S3A	B5
		23in.(60cm),3-Ld,Snap,No Resistance,IEC	EL024S3I	B5
		23in.(60cm),3-Ld,Mni Grabber (Clip),No Resistance,AHA	EL024M3A	B6
		23in.(60cm),3-Ld,Mni Grabber (Clip),No Resistance,IEC	EL024M3I	B6
	700-0006-00 700-0006-01	23in.(60cm),3-Ld,Grabber (Clip),No Resistance,AHA	EL024C3A	B5
		23in.(60cm),3-Ld,Grabber (Clip),No Resistance,IEC	EL024C3I	B5
	700-0007-08 700-0007-09	23in.(60cm),5-Ld,Snap,No Resistance,AHA	EL024S5A	C4
		23in.(60cm),5-Ld,Snap,No Resistance,IEC	EL024S5I	C4
	700-0006-08 700-0006-09	23in.(60cm),5-Ld,Grabber (Clip),No Resistance,AHA	EL024C5A	C5
		23in.(60cm),5-Ld,Grabber (Clip),No Resistance,IEC	EL024C5I	C5









Picture	OEM #	Descriptions	Order Code	price
<b>Spacelabs TRU-Link Type ECG Leadwires Set</b>				
 <p>EL040S3I</p> <p>EL040C5I</p>	700-0007-02	39in.(100cm),3-Ld,Snap,No Resistance,AHA	EL040S3A	B5
	700-0007-03	39in.(100cm),3-Ld,Snap,No Resistance,IEC	EL040S3I	B5
	700-0006-02	39in.(100cm),3-Ld,Grabber(Clip),No Resistance,AHA	EL040C3A	B6
	700-0006-03	39in.(100cm),3-Ld,Grabber (Clip),No Resistane,IEC	EL040C3I	B6
		39in.(100cm),5-Ld,Snap,No Resistance,AHA	EL040S5A	C4
		39in.(100cm),5-Ld,Snap,No Resistance,IEC	EL040S5I	C4
	700-0006-10	39in.(100cm),5-Ld,Grabber(Clip),No Resistance,AHA	EL040C5A	C5
	700-0006-11	39in.(100cm),5-Ld,Grabber(Clip),No Resistance,IEC	EL040C5I	C5
		36in.(90cm),10-Ld,Grabber(Clip),No Resistance,AHA	EL040C10A	E0
		36in.(90cm),10-Ld,Grabber(Clip),No Resistance,IEC	EL040C10I	E0
<b>Spacelabs TRU-Link Type ECG Leadwires Set</b>				
 <p>EB024S3A</p> <p>EB040C3I</p> <p>EB040S5A</p>	012-0418-00	24in.(61cm),3-Ld,Snap,No Resistance,AHA	EB024S3A	B2
	012-0519-00	24in.(61cm),3-Ld,Snap,No Resistance,IEC	EB024S3I	B2
	012-0417-00	24in.(61cm),3-Ld,Grabber (Clip),No Resistance,AHA	EB024C3A	B3
	012-0518-00	24in.(61cm),3-Ld,Grabber (Clip),No Resistance,IEC	EB024C3I	B3
	012-0416-00	24in.(61cm),5-Ld,Snap,No Resistance,AHA	EB024S5A	B5
	012-0517-00	24in.(61cm),5-Ld,Snap,No Resistance,IEC	EB024S5I	B5
		24in.(61cm),5-Ld,Grabber(Clip),No Resistance,AHA	EB024C5A	B5
		24in.(61cm),5-Ld,Grabber(Clip),No Resistance,IEC	EB024C5I	B5
	012-0464-00	35in.(90cm),3-Ld,Snap,No Resistance,AHA	EB040S3A	B2
	012-0518-00	35in.(90cm),3-Ld,Snap,No Resistance,IEC	EB040S3I	B2
	012-0465-00	35in.(90cm),3-Ld,Grabber(Clip),No Resistance,AHA	EB040C3A	B3
	012-0566-00	35in.(90cm),3-Ld,Grabber (Clip),No Resistance,IEC	EB040C3I	B3
	012-0419-00	35in.(90cm),5-Ld,Snap,No Resistance,AHA	EB040S5A	B5
	012-0520-00	35in.(90cm),5-Ld,Snap,No Resistance,IEC	EB040S5I	B5
	012-0466-00	35in.(90cm),5-Ld,Grabber(Clip),No Resistance,AHA	EB040C5A	B6
	012-0567-00	35in.(90cm),5-Ld,Grabber (Clip),No Resistance,IEC	EB040C5I	B6
<b>Spacelabs TRU-Link Type ECG Leadwires Set</b>				
 <p>EZ040S5A</p>		40in.(102cm),3-Ld,Snap,No Resistance,AHA	EZ040S3A	E4
		40in.(102cm),3-Ld,Snap,No Resistance,IEC	EZ040S3I	E4
		40in.(102am),3-Ld,Grabber(Clip),No Resistance,AHA	EZ040C3A	E0
		40in.(102cm),3-Ld,Grabber (Clip),No Resistance,IEC	EZ040C3I	E0
		40in.(102cm),5-Ld,Snap,No Resistance,AHA	EZ040S5A	D1
		40in.(102cm),5-Ld,Snap,No Resistance,IEC	EZ040S5I	D1
		40in.(102am),5-Ld,Grabber(Clip),No Resistance,AHA	EZ040C5A	D6
		40in.(102cm),5-Ld,Grabber (Clip),No Resistance,IEC	EZ040C5I	D6















## 6 ECG Telemetry Leadwires





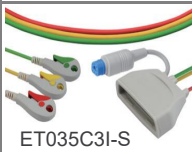
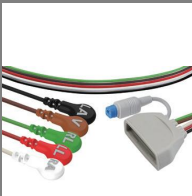
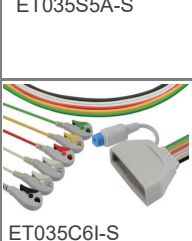

### Product Features

Photo	Feature	Advantage
	Spring-loaded gold-plated connector	Safe and reliable connection.
	Fully Shielded Leadwires Design	Reduces the risk of Electromagnetic Interference (EMI).
	Peelable Ribbon Cable Design	Prevents lead wire entanglement and can be customized to fit any patient's body size.
	Side button and visual connection design	(1) Provide clinicians with a locking and visualization mechanism to achieve faster, efficient and firm connections; (2) Clinically proven to reduce the risk of "leads off" false alarms.
	Easy to used electrode colors Lightweight smooth design	(1) Easy and quick lead placement; (2) Increase patient comfort.

OEM Manufacturer & Models	Product Guide	OEM #	Lead #	Descriptions	Order Code	price
<b>Compatible GE Healthcare</b>						
GE Healthcare Apex, Apex S, ApexPro Telemetry	 EE029S6A	421930-001	6	Multi-Link Leadwires Set,Snap, AHA, 36 in. (92cm)	EE029S6A	C0
		421931-001	6	Multi-Link Leadwires Set, Snap, IEC, 36 in. (92cm)	EE029S6I	C0
	 EE029C6I-G	421932-001	6	Multi-Link Leadwires Set,Grabber, AHA, 36 in. (92cm)	EE029C6A	C0
		421933-001	6	Multi-Link Leadwires Set,Grabber, IEC, 36 in. (92cm)	EE029C6I-G	C0
<b>Compatible Mindray (China)</b>						
Mindray TMS-6016, TEL-100	 HA052C3I	115-004872-00	3	Telemetry ECG Leadwires, Grabber, IEC, 31 in. (80cm)	HA052C3I	B7
		115-004871-00	3	Telemetry ECG Leadwires, Grabber, AHA, 31 in. (80cm)	HA052C3A	B7
		115-004868-00	3	Telemetry ECG Leadwires,Snap, IEC, 31 in. (80cm)	HA052S3I	B7
		115-004867-00	3	Telemetry ECG Leadwires,Snap, AHA, 31 in. (80cm)	HA052S3A	B7
	 HA052S5A	115-004874-00	5	Telemetry ECG Leadwires, Grabber, IEC, 31 in. (80cm)	HA052C5I	B9
		115-004873-00	5	Telemetry ECG Leadwires, Grabber, AHA, 31 in. (80cm)	HA052C5A	B9
		115-004870-00	5	Telemetry ECG Leadwires,Snap, IEC, 31 in. (80cm)	HA052S5I	B9
		115-004869-00	5	Telemetry ECG Leadwires,Snap, AHA, 31 in. (80cm)	HA052S5A	B9
Mindray Benevision Telemetry Transmitter TD60, TM-80	 ER036C3I	009-004769-00	3	Euro style ECG Leadwires, Snap,IEC, 36 in. (92cm), TPU, reusable	ER036S3I	C8
		009-004775-00	3	Euro style ECG Leadwires, Grabber, IEC, 36 in. (92cm), TPU, reusable	ER036C3I	C8
	 ER036S5I	009-004785-00	5	Telemetry ECG Leadwires, Snap, IEC, 36 in. (92cm), TPU, reusable	ER036S5I	C0
		009-004789-00	5	Telemetry ECG Leadwires, Grabber,IEC, 36 in. (92cm), TPU, reusable	ER036C5I	C0
	 ER036C6I	009-004797-00	6	Telemetry ECG Leadwires,Snap,IEC, 36 in. (92cm), TPU, reusable	ER036S6I	D2
		009-004801-00	6	Telemetry ECG Leadwires,Grabber,IEC, 36 in. (92cm), TPU, reusable	ER036C6I	D2
	 ERD036S5I	009-004780-00	3	Telemetry ECG Leadwires,Snap,IEC, 36 in. (92cm), single-patient	ERD036S3I	A8
		009-004792-00	5	Telemetry ECG Leadwires, Snap, IEC, 36 in. (92cm), single-patient	ERD036S5I	A0
			3	AHA, Snap, 40in.(100cm),single-patient	ERD036P3A	A8

OEM Manufacturer & Models	Product Guide	OEM #	Lead #	Descriptions	Order Code	price	
<b>Compatible Philips</b>							
Philips IntelliVue 862108, M2600B, M2601B Viridia, M4840A, M4841A	 HF040A5A	989803173141	3	Grabber and shower shield, AHA, 40 in. (92cm), Single patient	HF040A3A	A8	
		989803173151	5	Grabber and shower shield, AHA, 40 in. (92cm), Single patient	HF040A5A	A0	
	 HF040S3A	989803151981	3	Grabber and shower shield, IEC, 40 in. (92cm), Reusable	HF040A3I	C5	
		989803151991	3	Snap and shower shield, AHA, 40 in. (92cm), Reusable	HF040S3A	C5	
		989803152001	3	Snap and shower shield, IEC, 40 in. (92cm), Reusable	HF040S3I	C5	
	 HF040A5I	989803152071	5	Snap and shower shield, AHA, 40 in. (92cm), Reusable	HF040S5A	C0	
		989803152061	5	Grabber and shower shield, IEC, 40 in. (92cm), Reusable	HF040A5I	C0	
		989803152081	5	Snap and shower shield, IEC, 40 in. (92cm), Reusable	HF040S5I	C0	
			5	Grabber and shower shield, AHA, 51in.(130cm), Reusable	HF050C5A	C0	
			5	Grabber and shower shield, IEC 51in.(130cm), Reusable	HF050C5I	C0	
			5	Grabber and shower shield, AHA IEC, 51in.(130cm), Reusable	HF050S5A	C0	
			5	Snap and shower shield, IEC, 51 in. (130cm), Reusable	HF050S5I	C0	
			5	Telemetry ECG Leadwires, AHA, Snap, 40in.(100cm), single-	HFD040P5A	C0	
			5	Telemetry ECG Leadwires, IEC, Snap, 40in.(100cm), single-	HFD040P5I	C0	
		Philips IntelliVue MX40 ECG Only (Reusable)	 ET035C3I	989803171901	3	Grabbers, IEC, 35in. (90cm), TPU	ET035C3I
	989803171801			3	Grabbers, AHA, 35in. (90cm), TPU	ET035C3A	D5
	 ET035S5A		989803171931	5	Grabbers, IEC, 35in. (90cm), TPU	ET035C5I	E5
			989803171831	5	Grabbers, AHA, 35in. (90cm), TPU	ET035C5A	E5
989803171821			5	Snaps, AHA, 35in. (90cm), TPU	ET035S5A	E5	
 ET035C6I	989803171961		6	Grabbers, IEC, 35in. (90cm), TPU	ET035C6I	E0	
	989803171861		6	Grabbers, AHA, 35in. (90cm), TPU	ET035C6A	E0	

Compatible Models	Product Guide	OEM #	Lead #	Descriptions	Order Code	price	
<b>Compatible Philips</b>							
Philips IntelliVue MX40 ECG Only (Reusable)	 ET035S5A-S		3	Snap, AHA, 35in.(90cm)	ET035S3A	G4	
			3	Snap, IEC, 35in.(90cm)	ET035S3I	G4	
			5	Snap, IEC, 35in.(90cm)	ET035S5I	G8	
			5	Grabber(Clip), AHA	ET035S5A-S	G8	
			5	Grabber(Clip), IEC	ET035C5A-S	G4	
		 ET035S3I-S		5	Grabber(Clip), AHA	ET035S5I-S	G8
				3	Grabber(Clip), IEC	ET035S3I-S	G8
				5	Snap, AHA, 35in.(90cm), PVC	ETD035P5A	G8
	5		Snap, IEC, 35in.(90cm), PVC	ETD035P5I	G8		
Philips IntelliVue MX40 ECG+SPO2 (Reusable)	 ET035C3I-S	989803171911	3	Grabbers, IEC, 35in. (90cm), TPU	ET035C3I-S	G8	
		989803171811	3	Grabbers, AHA, 35in. (90cm), TPU	ET035C3A-S	E0	
	 ET035S5A-S	989803171951	5	Grabbers, IEC, 35in. (90cm), TPU	ET035C5I-S	E0	
		989803171841	5	Snaps, AHA, 35in. (90cm), TPU	ET035S5A-S	G8	
		989803171851	5	Grabbers, AHA, 35in. (90cm), TPU	ET035C5A-S	G8	
			5	Snap,IEC, 35in.(90cm),TPU	ET035S5I-S	G8	
			3	Snap,IEC, 35in.(90cm),TPU	ET035S3I-S	G8	
		 ET035C6I-S	989803171971	6	Grabbers, IEC, 35in. (90cm), TPU	ET035C6I-S	G8
	989803171871		6	Grabbers, AHA, 35in. (90cm), TPU	ET035C6A-S	G8	
	Philips IntelliVue MX40 ECG Only (Single patient)	 ETD035S3A		3	Snap, AHA, 35in. (90cm), PVC	ETD035S3A	A1
			3	Snap, IEC, 35in. (90cm), PVC	ETD035S3I	C6	
 ETD035S5A			5	Snap, AHA, 35in. (90cm), PVC	ETD035S5A	C8	
			5	Snap, IEC, 35in. (90cm), PVC	ETD035S5I	C8	
 ETD035C5A		989803172031	5	Grabbers, AHA, 35in. (90cm), PVC	ETD035C5A	C8	
		989803172131	5	Grabbers, IEC, 35in. (90cm), PVC	ETD035C5I	C8	

Compatible Models	Product Guide	OEM #	Lead #	Descriptions	Order Code	price
<b>Compatible Philips</b>						
Philips IntelliVue MX40 ECG Only (Single patient)	 ETD035C6A		6	Grabbers, AHA, 35in. (90cm), PVC	ETD035C6A	C8
			6	Grabbers, IEC, 35in. (90cm), PVC	ETD035C6I	C8
	 ET035S3I		3	Snap, IEC, 35in.(90cm), TPU	ET035S3I	C7
			5	Grabber, AHA/IEC, 50in. (1.27m), PVC	ET050C5A	C7
			5	Grabber, AHA/IEC, 50in. (1.27m), PVC	ET050C5I	C6
Philips IntelliVue MX40 ECG+SPO2 (Single patient)	 ETD035S3A-S		3	Snap, AHA, 35in. (90cm), PVC	ETD035S3A-S	C8
			3	Snap, IEC, 35in. (90cm), PVC	ETD035S3I-S	C8
	 ETD035S5A-S		5	Snap, AHA, 35in. (90cm), PVC	ETD035S5A-S	C0
			5	Snap, IEC, 35in. (90cm), PVC	ETD035S5I-S	C0
	 ETD035C5A-S	989803172051	5	Grabbers, AHA, 35in. (90cm), PVC	ETD035C5A-S	C0
		989803172151	5	Grabbers, IEC, 35in. (90cm), PVC	ETD035C5I-S	C0
	 ETD035S6A-S		6	Snap, AHA, 35in. (90cm), PVC	ETD035S6A-S	C0
			6	Snap, IEC, 35in. (90cm), PVC	ETD035S6I-S	C0









## 7 Holter Recorder ECG Cables with Leads





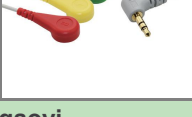

### Compliance with



ANSI/AAMI EC53  
IEC 60601-1  
ISO 10993-1  
ISO 10993-5  
ISO 10993-10

### Quality Management System

ISO13485: 2016  
QSR820

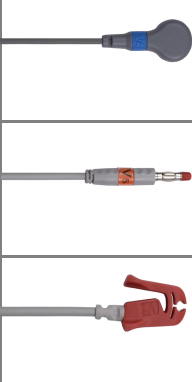

Compatible Models	Product Picture	OEM #	Order Code	Descriptions	Price
<b>Compatible Biomedical Instruments (BI)/Brentwood</b>					
Biomedical Instruments			HA055S7A	One-piece Holter ECG Cables, 18in. (45cm), 7-Ld, AHA, Snap	C0
<b>Compatible Creative (China)</b>					
PC-80 Easy ECG Monitor, 2.5mm jack plug			HA022S3A	One-piece Holter ECG Cables, 18in. (45cm), 3-Ld, AHA, Snap	B5
<b>Compatible Fukuda Denshi</b>					
		CMF-86C	HA057C4A	One-piece Holter ECG Cables, 31 in. (80cm), 4-Ld, AHA, Grabber	C0
			<b>NEW</b> HA057C4I	One-piece Holter ECG Cables, 31 in. (80cm), 4-Ld, IEC, Grabber	C0
			<b>NEW</b> HA057P4A	One-piece Holter ECG Cables, 31 in. (80cm), 4-Ld, IEC, Grabber	C0
<b>Compatible Landcom, Also See Meigaoyi</b>					
Visual Stethoscope			HA020C3I	One-piece Holter ECG Cables, 40 in. (102cm), 3-Ld, IEC, Grabber	B4
MGY-M1			HA020S3I	One-piece Holter ECG Cables, 40 in. (102cm), 3-Ld, IEC, Snap	B3
<b>Compatible Meigaoyi</b>					
ECGLAB TDA3.0			HA046S5A	One-piece Holter ECG Cables, 40 in. (102cm), 5-Ld, AHA, Snap	A1
<b>Compatible Mortara</b>					
Mortara: H12/H12+, X12/X12+		9293-017-50	HA035S10I	One-piece Holter ECG Cables, 40 in. (102cm), 10-Ld, IEC, Snap	E5

Compatible Models	Product Picture	OEM #	Order Code	Descriptions	Price
<b>Compatible GE-Marquette/Rozinn</b>					
GE, Marquette: 8000, 8200, 8500, Rozinn SEER Holter Recorder model: 151			HA021S3A	One-piece Holter ECG Cables, 28 in. (70cm), 3-Ld, AHA, Snap	C5
<b>Compatible GE Healthcare</b>					
SEER Light		2008594-001	HA053S5A	One-piece Holter ECG Cables, 55 in. (1.4M), 5-Ld. AHA, Snap	E3
		2008594-002	HA053S7A	One-piece Holter ECG Cables, 55 in. (1.4M), 7-Ld. AHA, Snap	E5
		2008594-004	HA053S7I	One-piece Holter ECG Cables, 55 in. (1.4M), 7-Ld, IEC, Snap	E5
		2008594-002	HA130S7A	One-piece Holter ECG Cables, 55 in. (0.65M), 7-Ld, AHA, Snap	E5
<b>Compatible M&amp;B (China)</b>					
GE, Marquette: 8000, 8200, 8500 Rozinn SEER Holter Recorder model: 151			HA132S5A-C	One-piece Holter ECG Cables, 28 in. (70cm), 3-Ld, AHA, Snap	A0
<b>Compatible MBELEC</b>					
CD2000-1800			HA052S3A	One-piece Holter ECG Cables, 28 in. (70cm), 3-Ld, AHA, Snap	B8
<b>Compatible PI</b>					
			HA048S4I	One-piece Holter ECG Cables, 40 in. (102cm), 4-Ld, IEC, Snap	D0
			HA048S6I	One-piece Holter ECG Cables, 40 in. (102cm), 6-Ld, IEC, Snap	D0

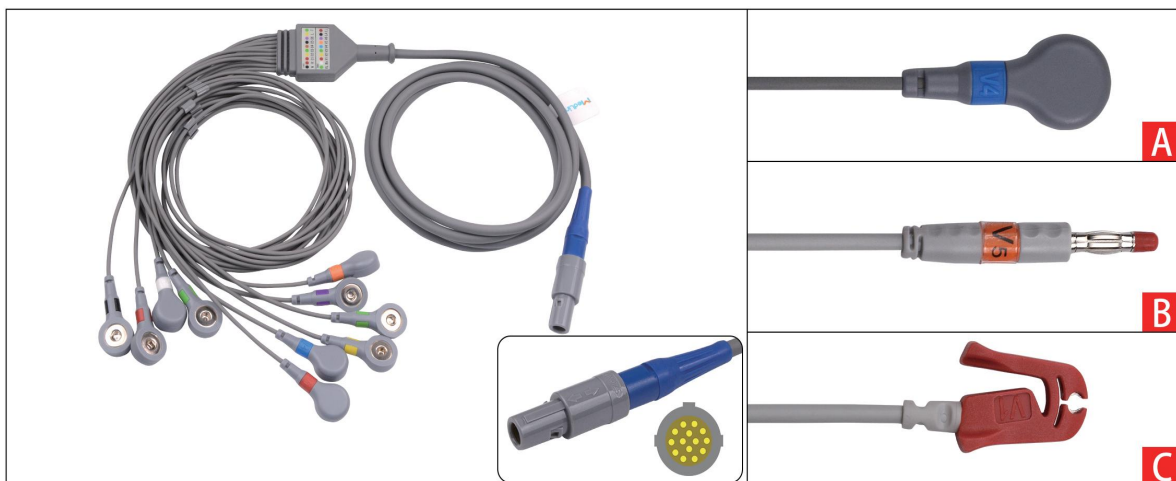

Compatible Models	Product Picture	OEM #	Order Code	Descriptions	Price
<b>Compatible Philips</b>					
Zymed DigiTrak-Plus		M4725A, 350-0173-03	HA056S5A	Reusable One-piece Holter ECG Cables, 35 in.(0.9M),5Ld,AHA,Snap	D0
			HA056S5I	Reusable One-piece Holter ECG Cables,35in.(0.9M),5Ld,IEC,Snap	D0
Zymed DigiTrak XT		989803157491	HA062P5A	Disposable One-piece Holter ECG Cables,35 in.(0.9M),5-Ld,AHA,Snap	D0
			HA062P5I	Disposable One-piece Holter ECG Cables, 35 in.(0.9M),5-Ld,IEC,Snap	D0
<b>Compatible Jincomed</b>					
MIC-12H Series MIC-3H Series			HA133S10A	One-piece Holter ECG Cables,11pin,10-Ld,AHA,Snap,43in.(1.1M)	E5
			HA133S10I	One-piece Holter ECG Cables,11pin,10-Ld IEC,Snap,43in.(1.1M)	E5
<b>Compatible Welch Allyn</b>					
Welch Allyn SE-PRO-600 PRO ECG recorder module		SE-PC-IEC-PUSH	HA135S10I	14pin,10-Lead,Snap, IEC,2.3m	F0
		/	HA135S10A	14pin,10-Lead,Snap, AHA,2.3m	F0
		RE-PC-IEC-BAN	HA135B10I	14pin,10-Lead,Banana, IEC,2.3m	F0
		RE-PC-AHA-BAN	HA135B10A	14pin,10-Lead,Banana, AHA,2.3m	F0
		SE-PC-IEC-CLIP	HA135C10I	14pin,10-Lead,Clip, IEC,2.3m	F0
		SE-PC-AHA-CLIP	HA135C10A	14pin,10-Lead,Clip, AHA,2.3m	F0



Compatible Models	Product Picture		OEM #	Order Code	Descriptions	Price
<b>Compatible (BI)/Brentwood</b>						
Biomedical Instruments (BI): BI 9000 Brentwood: BH-9000				HC024-7A	Holter ECG Trunk Cables, 18in. (45cm), Din 7-Ld, AHA, fit for Din 1.5mm style LeadWires	D5
BI 9800				HC024-10A	Holter ECG Trunk Cables, 18in. (45cm), 10-Ld, AHA, fit for Din style LeadWires	D6
<b>Compatible Biox</b>						
Biox: CB-2300-A Biomedical Instruments (BI): BI9000TL				HC033-7A	Holter ECG Trunk Cables, 18in. (45cm), Din 7-Ld, AHA, fit for Din style LeadWires	C5
<b>Compatible Burdick</b>						
92512 Holter				HC030-5A	Holter ECG Trunk Cables, 31 in. (80cm), Din 5-Ld, AHA, fit for Din style LeadWires	B0
BI 9800				HC030-7A	Holter ECG Trunk Cables, 18in. (45cm), Din 7-Ld, AHA, fit for Din style LeadWires	C5
<b>Compatible Landcom</b>						
				HC031-7A	Holter ECG Trunk Cables, 18in. (45cm), Din 7-Ld, AHA, fit for Din style LeadWires	D6
				HC031-10A	Holter ECG Trunk Cables, 18in. (45cm), Din 10-Ld, AHA, fit for Din style LeadWires	D0
<b>Compatible Medilog</b>						
Medilog: FD5				HC051-7A	Holter ECG Trunk Cables, 18in. (45cm), Din 7-Ld, AHA, fit for Din style LeadWires	C5
<b>Compatible GE-Marquette/Rozinn/GeTeMED</b>						
For GE Marquette: 8000, 8200, 8500, SEER Holter Recorder model: 151			E9002TE	HC006-7A	Holter ECG Trunk Cables, 18in. (45cm), Din 7-Ld, AHA, fit for Din style LeadWires	D7
<b>Compatible GE-Marquette Rozinn</b>						
For GE SEER MC Holter Recorder			E9002TK	HC047-5A	Holter ECG Trunk Cables, 31 in. (80 cm), Din 5-Ld, AHA, fit for Din style	B0
			E9002TL	HC047-7A	Holter ECG Trunk Cables, 31 in. (80 cm), Din 7-Ld, AHA, fit for Din style	B0
			E9002TP	HC047-10A	Holter ECG Trunk Cables, 31 in. (80 cm), Din 10-Ld, AHA, fit for Din style	E5

Compatible Models	Product Picture	OEM #	Order Code	Descriptions	Description	Price
<b>Compatible Din 1.5 Style Normal</b>						
Suitable for all Din-Plug System	 EC024S3		EC024S3A	Din Holter Leadwires 24in.(61cm),3-Ld,AHA	Snap	A6
			EC024C3I	Din Holter Leadwires 24 in.(61cm),3-Ld,IEC	Grabber	A7
			HC096S10A	Din Holter Leadwires, 96in(2.43m),10-Ld,AHA	Snap	A0
			HC096S10I	Din Holter Leadwires, 96in(2.43m),10-Ld,IEC	Snap	A0
			HC072S10A	Din Holter Leadwires, 72in(1.83m),10-Ld,AHA	Snap	B1
			HC072S10I	Din Holter Leadwires, 72in(1.83m),10-Ld,IEC	Snap	A6
			HC120S10A	Din Holter Leadwires 120in(3.05m),10-Ld,AHA	Snap	A7
			HC120S10I	Din Holter Leadwires, 120in(3.05m),10-Ld,AHA	Snap	A7
			EC024S5A	Din Holter Leadwires, 24 in.(61cm),5-Ld,AHA	Snap	A7
			EC024S5I	Din Holter Leadwires, 24 in.(61cm),5-Ld,IEC	Snap	A0
			EC024C5I	Din Holter Leadwires, 24in.(61cm),5-Ld,IEC	Grabber	A0
			EC040S3A	Din Holter Leadwires, 40 in.(102cm),3-Ld,AHA	Snap	B1
		EC040C3A	Din Holter Leadwires, 40 in.(102cm),3-Ld,AHA	Grabber	B1	
		EC040C3I	Din Holter Leadwires, 40 in.(102cm),3-Ld,IEC	Grabber	A0	
		EC040C3I-RL	Din Holter Leadwires, 40 in.(102cm),3-Ld,IEC	Grabber (RL Style)	B4	
		EC040C3A-RL	Din Holter Leadwires, 40 in.(102cm),3-Ld,AHA	Grabber	B4	
		EC040S5A	Din Holter Leadwires 40 in.(102cm),5-Ld,AHA	Snap	B4	
		EC040C5A	Din Holter Leadwires, 40 in.(102cm),5-Ld,AHA	Grabber	B4	
		EC040S5I	Din Holter Leadwires 40 in.(102cm),5-Ld,IEC	Snap	B4	
		EC040C5I-RL	Din Holter Leadwires, 40 in.(102cm),5-Ld,IEC	Grabber(R L Style)	B5	
		EC040C5A-RL	Din Holter Leadwires 40 in.(102cm),5-Ld,AHA	Grabber(R L Style)	B0	
		HC024S7A	Din Holter Leadwires, 24 in.(61cm),7-Ld,AHA	Snap	B0	
		HC024S7I	Din Holter Leadwires, 24 in.(61cm),7-Ld,IEC	Snap	B0	
		HC040S7A	Din Holter Leadwires, 40 in.(102cm),7-Ld,AHA	Snap	C1	
		HC040S7I	Din Holter Leadwires, 40 in.(102cm),7-Ld,IEC	Snap	C2	
		HC040C7I	Din Holter Leadwires, 40 in.(102cm),7-Ld,IEC	Grabber	C2	
		HC018S10I	Din Holter Leadwires, 18 in.(45cm),10-Ld,IEC	Snap	C2	
		HC024S10A	Din Holter Leadwires, 24 in.(61cm),10-Ld,AHA	Snap	C2	
		HC040S10A	Din Holter Leadwires, 40 in.(102cm),10-Ld,AHA	Snap	C2	
		HC040C10I	Din Holter Leadwires, 40 in.(102cm),10-Ld,IEC	Grabber	C2	
	 HC040S7					

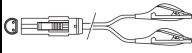
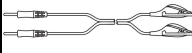
Compatible Models	Product Picture	OEM #	Order Code	Descriptions	Price
<b>Compatible Din 2.0 Plug Style</b>					
Suitable for all Din 2.0 Plug System			HT040S3A	Din 2.0 plug lead wires, 40 in. (102cm), 3-Ld, AHA	A6

<b>Direct-Connect (one-piece) Temporary Pacemaker Leadwire</b>					
Medtronic 5388 Temporary Pacemaker		5832	HC060C2AI	Reusable small clip short channel A or V 6ft	
		5832S		Reusable small clip Long channel A or V 12ft	
Medtronic 5318,5388, 5348, 53401 Temporary Pacemaker			HC066C2A	Din 2mm plug with alligator clip	
<b>Temporary Pacemaker Cable and Leadwire</b>					
Medtronic 5318,5388, 5348, 53401 Temporary Pacemaker			HC067C2A	Din 2mm Sockets with alligator clip	

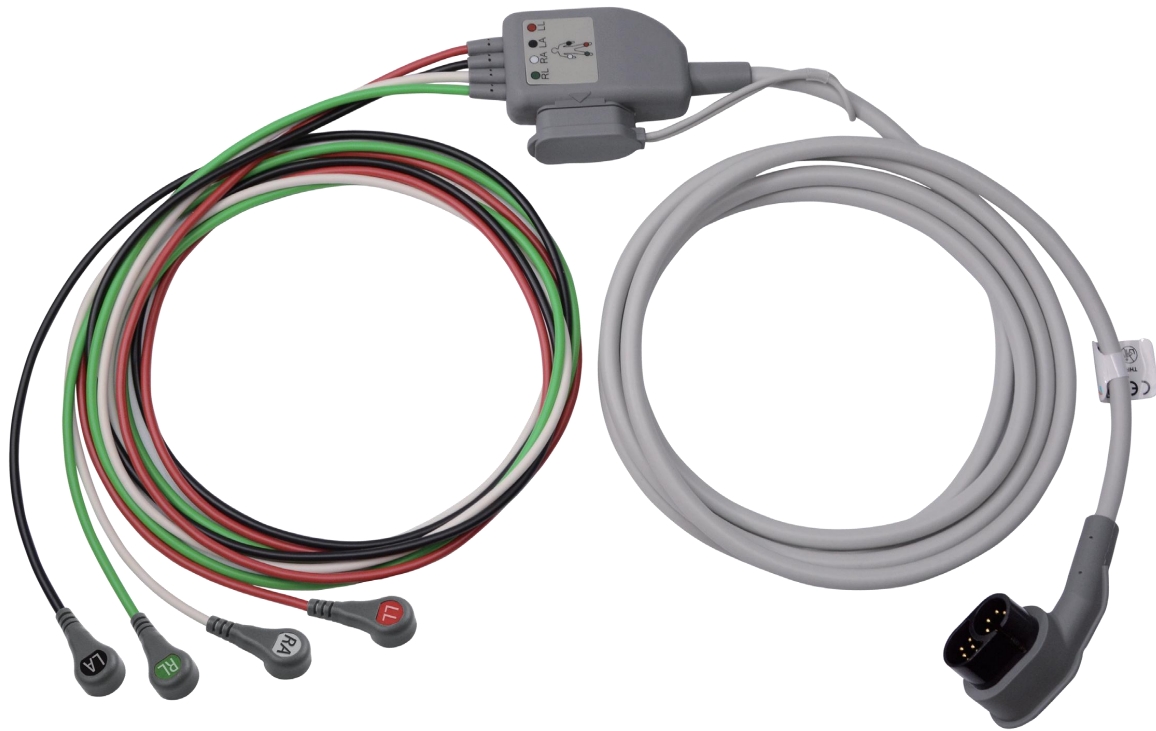





## 8 Defibrillation ECG Cables

### Product Features

1. Integrated plug connector, solid and easy to clean;
2. The color code of the electrode connector, easy to read and use;
3. Excellent shielding performance and anti-interference performance, better signal quality.



Compatible Models/ Connector	Photo	OEM #	Descriptions	Order Code	Price
<b>Compatible Medtronic-Physio Control</b>					
Lifepak 11, Lifepak 12, Lifepak 15, Lifepak 20, Lifepak 20E  		11111-000022	Chest Lead, 7pin, 6-Lead, Grabber, AHA, 3ft	VA072SFA	
		/	Chest Lead, 7pin, 6-Lead, Grabber, IEC, 3ft	VA072SFI	
		11111-000020	Limb Lead, 12pin, 4-Lead, Grabber, AHA, 8ft	VA073SFA	
		/	Limb Lead, 12pin, 4-Lead, Grabber, IEC, 8ft	VA073SFI	
<b>Compatible ZOLL</b>					
E Series /CCT M Series  		8000-1006	Limb Lead, 15pin, 4-Lead, Grabber, AHA, 10ft	VA074SBA	
		/	Limb Lead, 15pin, 4-Lead, Grabber, IEC, 10ft	VA074SBI	
			Limb Lead, 12pin, 4-Lead, Grabber, AHA/IEC, 10ft	VA074SFA VA074SFI	
		8000-1008-01	Chest Lead, 7pin, 6-Lead, Grabber, AHA, 3.5ft	VA075SNA	
		/	Chest Lead, 7pin, 6-Lead, Grabber, IEC, 3.5ft	VA075SNI	
		8000-1007-01	One Piece ECG Cables, 15pin, 12-Lead, Grabber, AHA, 10ft+3.5ft	VA076SBA	
		8000-1007-02	One Piece ECG Cables, 15pin, 12-Lead, Grabber, IEC, 10ft+3.5ft	VA076SBI	
X Series		8300-0803-01	Limb Lead, 12pin, 4-Lead, Grabber, AHA, 10ft	VA060SBA	
		8300-0803-12	Limb Lead, 12pin, 4-Lead, Grabber, IEC, 10ft	VA060SBI	
			Limb Lead, 12pin, 4-Lead, Grabber, AHA/IEC, 4ft	VA060ABA VA060ABI	
			Limb Lead, 12pin, 4-Lead, Grabber, AHA/IEC, 10ft	VA060CBA VA060CBI	
		8300-0804-01	Chest Lead, 12pin, 6-Lead, Grabber, AHA, 3ft	VA061SBA	
		8300-0804-12	Chest Lead, 12pin, 6-Lead, Grabber, IEC, 3ft	VA061SBI	
			Chest Lead, 12pin, 6-Lead, Grabber, AHA/IEC, 3ft	VA061ABA VA061ABI	
		8300-0802-01	One Piece ECG Cables, 12pin, 12-Lead, Grabber, AHA, 10ft+3ft	VA070SBA	
		8300-0802-12	One Piece ECG Cables, 12pin, 12-Lead, Grabber, IEC, 10ft+3ft	VA070SBI	



## Diagnosis EKG Cable & Accessories

### Specification

Cable Material	TPU jacket,light gray
Connector &Yoke	Golden plated pins Injection molding process
Trunk Cable Length	1.8m
Lead Wire Length	1.26m(limb lead);0.76m(chest lead)
Connector Proximal	Banana,grabber (Clip),snap,3mm needle

### Compliance with

ANSI/AAMI EC53  
 IEC 60601-1  
 ISO 10933-1  
 ISO 10933-5  
 ISO 10933-10

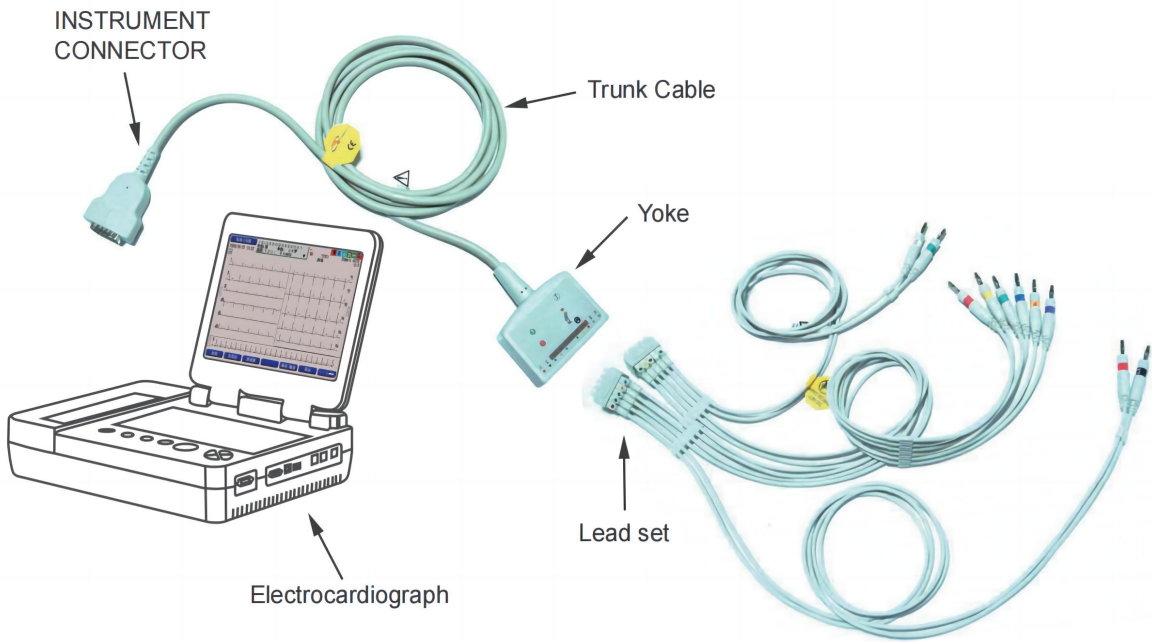

### Type Designation

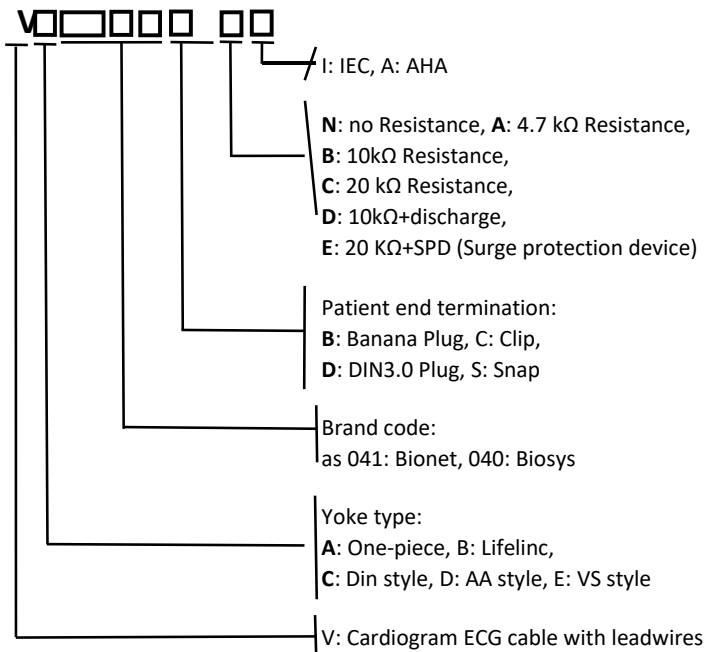

### Mainly Compatible Brands

- ◆ Philips
- ◆ GE-Marquette
- ◆ Schiller
- ◆ Nihon Kohden
- ◆ Spacelabs
- ◆ Mindray (China)
- ◆ Mortara
- ◆ Fukuda Denshi
- ◆ Edan (China)

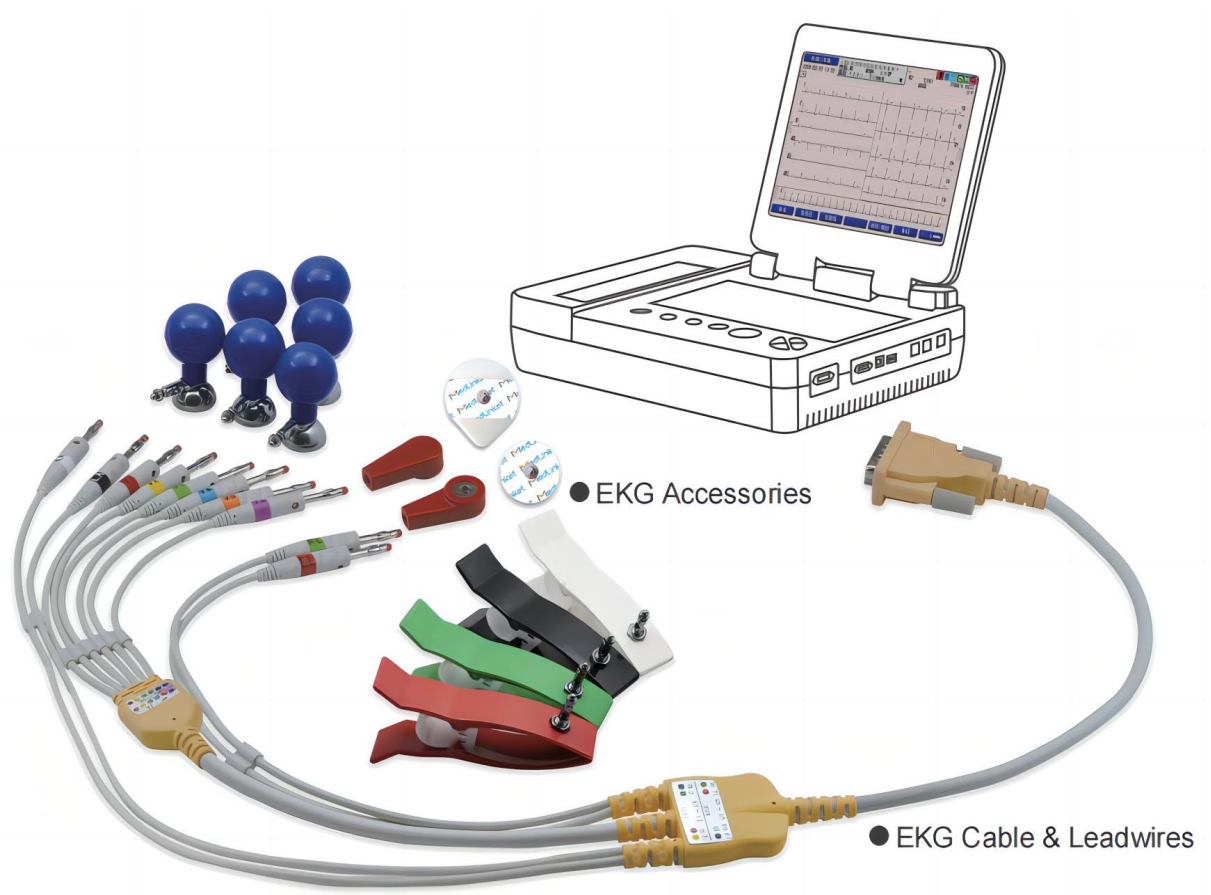

**Lead Position Marked**

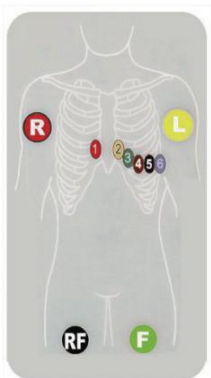

12 Lead: I  
Standard IEC

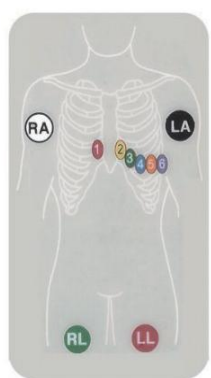

12 Lead: A  
Standard AHA

S: Standard Snap



C: Clip (type RL Grabber)



D: Din 3.0



B: Banana 4.0

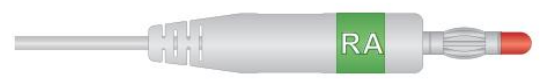









Code	AHA (A)	IEC (I)	Alternate IEC
Snap End	<p>RA RL V1 V2 V3 V4 V5 V6 LA LL</p>	<p>N R C1 C2 C3 C4 C5 C6 L F</p>	<p>L R C1 C2 C3 C4 C5 C6 F RF</p>
Grabber End	<p>RA RL V1 V2 V3 V4 V5 V6 LA LL</p>	<p>N R C1 C2 C3 C4 C5 C6 L F</p>	<p>L R C1 C2 C3 C4 C5 C6 F RF</p>
4mm Banana end	<p>RA RL V1 V2 V3 V4 V5 V6 LA LL</p>	<p>N R C1 C2 C3 C4 C5 C6 L F</p>	<p>L R C1 C2 C3 C4 C5 C6 F RF</p>
3mm Needle end	<p>RA RL V1 V2 V3 V4 V5 V6 LA LL</p>	<p>N R C1 C2 C3 C4 C5 C6 L F</p>	<p>L R C1 C2 C3 C4 C5 C6 F RF</p>



# 1 Direct-Connect EKG Cables



## Product Features

1. Integrated design, convenient for use and maintenance;
2. Meeting the requirements of EC53;
3. Outstanding shielding property, Reduces the risk of Electromagnetic Interference (EMI);
4. Excellent defibrillation-proof performance, protecting the equipment well;
5. Flexible and durable cables;
6. Outstanding cable material, enduring repeated cleaning and disinfection;
7. Latex free.

OEM Manufacturer & Models	Connector	OEM #	Order Code	Descriptions	Price
<b>Compatible Burdick</b>					
EK-10, E350, E350I, E550, E560, Eclipse LE, EK10, Elite, Elite II		012-0700-00 7517,7514, 7705,7706	VA002BNI	Banana,No Resistance,IEC	C7
			VA002BNA	Banana,No Resistance,AHA	C7
			VA002CNI	Grabber,No Resistance,IEC	C7
Burdick Quinton Eclipse 4, 8, 400, 800, 850, Plus and Elite II, ATRIA Plus Quinton			VA004BAI	Banana,4.7kΩ Resistance,IEC	E4
			VA004BNI	Banana,No Resistance,IEC	E4
			VA004DNI	Din3.0,No Resistance,IEC	C2
Eclipse 4/400/8/800/850/ 850i, Eclipse Plus, Atria 3000		007704,007725, 012-0844-00, 012-0844-01, 007785	VA005BBA	Banana,10kΩ Resistance,AHA	C3
			VA005BBI	Banana,10kΩ Resistance,IEC	C0
<b>Compatible Edan (China)</b>					
Edan: SE-1010PC, SE-12, SE-12 Express, SE-1200, SE-3, SE-601A, SE-601B, SE-601C, ST-1212, Datascope: DECG-03A Nihon Kohden: BSM-2301K, Spacelabs: SL6		01.57.107048 01.57.471017	VA030BBI	Banana,10kΩ Resistance,IEC	C0
			VA030BBA	Banana,10kΩ Resistance,AHA	C0
			VA030CB	Grabber,10kΩ Resistance,IEC	C0
			VA030SBI	Snap,10kΩ Resistance,IEC	C9
<b>Compatible Fukuda Denshi</b>					
CardiMax FX-7202/7402-710/ 7102, FCP 2155, FCP 2201,FCP 4101, FCP 4101A, FX-101, FX-102F, FX-3010, FX-328UY		CP-101LD,CP-104L	VA017BAI VA017BAA	Banana,4.7kΩ Resistance, IEC/AHA	C0
			VA017DAI	Din3.0,4.7kΩ Resistance,IEC	C9
			VA017BBI	Banana,10kΩ Resistance,IEC	C0
			VA017CAI	Grabber,4.7kΩ Resistance,IEC	C0
<b>Compatible Fukuda Me</b>					
Cardisuny, KP-500, KP-500D			VA024BNI	Banana,No Resistance,IEC	E0
			VA024SNA	Snap,No Resistance,AHA	E9
FX-031			VA014BNA	Banana,No Resistance,AHA	E0
			VA014DNI	Din3.0,No Resistance,IEC	E9
<b>Compatible GE-Marquette</b>					
MAC 1000, MAC 1100, MAC 1200, MAC 1600, MAC 2000, MAC 3500, MAC 400, MAC 500, MAC 600, MAC 800, Microsmart M		Sage P/N:A02-10B	VA008BBI VA008BBA	Banana,10kΩ Resistance,IEC/AHA	C0
			VA008CBA VA008CBI	Grabber,10kΩ Resistance,AHA/IEC	C0
			VA008DBA VA008DBI	Din3.0,10kΩ Resistance,AHA/IEC	C0
			VA008SBI	Snap,10kΩ Resistance,IEC	C0

OEM Manufacturer & Models	Connector	OEM #	Order Code	Descriptions	Price
<b>Compatible Hellige/Siemens/Bosch</b>					
<b>Hellige:</b> Cardiosys, EK36, EK403, EK41, EK413, EK43, EK512, EK53 <b>Siemens:</b> Cardiostat1/3T/703/710/31/31S <b>Bosch:</b> 603 D, 603 ER, 603 S, 606			VA029BAI	Banana,4.7kΩ Resistance,IEC	E4
			VA029BNI	Banana,No Resistance,IEC	E2
			VA029SAI	Snap,4.7kΩ Resistance,IEC	E3
			VA029CNI	Grabber,No Resistance,IEC	E2
<b>Compatible Kenz/Cardioline</b>					
<b>Kenz:</b> 103, 106, 107, 1201, 302, 303 <b>Cardioline:</b> Delta 1, Delta 1 Plus, Delta 3, Delta 3 Plus, Delta 30, Delta 30D, Delta 60, Delta 60 Plus, ECG 10610, 1210, 1211, 601, Cardico 302		PC-104,63050074, 63050075,895.0586	VA016BAI	Banana,4.7kΩ Resistance,IEC	D5
			VA016SAI	Snap,4.7kΩ Resistance,IEC	E4
			VA016BNI	Banana,No Resistance,IEC	D5
			VA016CNI	Grabber,No Resistance,IEC	E3
			VA016SNI	Snap,No Resistance,IEC	E2
<b>Kenz:</b> 108, 109, 110, 1210, 1211, 601, Cardico 302		K131	VA015BNA VA015BNI	Banana,No Resistance,AHA/IEC	C0
			VA015DNI	Din3.0,No Resistance,IEC	C9
<b>Compatible Medtronic</b>					
Lifepak 11, Lifepak 12, Lifepak 15, Lifepak 20			VA013SBI	Snap, 10kΩ Resistance, IEC	F5
<b>Compatible (China)</b>					
DPM6, DPM7, Passport 12mm, Passport 17m, T1			VA020BBA	Banana, 1kΩ Resistance,AHA	D0
			VA020CBA VA020CBI	Grabber, 1kΩ Resistance,AHA/IEC	D0
			VA020SBI	Snap, 1kΩ Resistance,IEC	D9
			VA020SBA	120in.(3.06m),Snap,1kΩ Resistance,5-LD,AHA	D9
<b>Compatible Mortara</b>					
ELI 100, ELI 50, ELI 200 Landscape, Portrait, Xscribe DOS			VA025BAA VA025BAI	Banana,4.7kΩ Resistance, AHA/IEC	E0
Martara Surveyor			VA035SBI	Snap,10kΩ Resistance,IEC	F0

OEM Manufacturer & Models	Connector	OEM #	Order Code	Descriptions	Price
<b>Compatible Nihon Kohden, Biocare/Cardioline</b>					
BIO CARE:101B, 101G, 1200, 300, 300G, 9803, ECG-101, Cardioline: AR1200 viewBT, AR1200adv, AR2100 viewBT, AR2100adv, AR600adv, Nihon Kohden:ECG-9620/ 9010/9020, ECG- 9022/9110/9130/9132/ Dongjiang		BA-902D	VA001BNA VA001BNI	Banana,No Resistance,AHA/IEC	C3
		BA-903D	VA001CNI	Grabber,No Resistance,IEC	B0
		BA-901D	VA001DNI	Din3.0,No Resistance,IEC	B0
Nihon Kohden: Cardiofax 6151/6353, Cardiofax EKG- 8270/8350/8370/8420/84 23/8450/8453/8820/8823/ 8830/9130			VA001BAA VA001BAI	Banana,4.7kΩ Resistance, AHA/IEC	C0
			VA001DAA	Din3.0,4.7kΩ Resistance,AHA	C9
			VA001SAI	Snap,4.7kΩ Resistance,IEC	C9
BSM-2301, BSM- 2353, BSM-5100			VA036SNI	Snap,No Resistance,IEC	F1
		BJ-900P	VA036CNI	Grabber,No Resistance,IEC	F2
Nihon Kohden: Cardiofax Q ECG- 9110K, Cardiofax Q ECG-9130K ECG-9130P, ECG- 9620P, special screw, imperial standard(SAE)			VA009BNI	Banana,No Resistance,IEC	C3
			VA009DNI	Din3.0,No Resistance,IEC	C2
			VA009SNI	Snap,No Resistance,IEC	C3
5151A, 5403A, 5503A, 5504A, 6151, 6151A, 6151B, 6306A,6353,6353A, 6543A, 6851, 8110, 8330, 8330A, Cardiofax, Escape 12		45502-NK	VA004BNI	Banana,No Resistance,IEC	C3
			VA004DNI	Din3.0,No Resistance,IEC	C2
ECG-9320 ECG-9522P (Original part No.: BR- 911D)			VA010DCA	Din3.0,No Resistance,AHA	J0
			VA010CCI	Grabber,No Resistance,IEC	J0
<b>Compatible Petas (Turkey)</b>					
			VA023BNI	Banana, No Resistance, IEC	E0
<b>Compatible Philips</b>					
Philips: 200, 200i, Agilent 300PI, Agilent 300i, M1770A, M1771A, M1772A, Pagewriter 100/200,Pagewriter 300PI/TC20Burdick: ELI 150, ELI 210, ELI 230, ELI 250, ELI 250C, ELI 350 Spacelabs: CardioDirect 12Welch Allyn: CP 10, CP 150, CP 20, CP 250, CP 50		Philips P/N: M2461A,M3702C 989803107711	VA018BCA VA018BCI	Banana,20kΩ Resistance,AHA/IEC	C0
		Burdick P/N 9293-033-50 9293-033-52	VA018SCA VA018SCI	Snap,20kΩ Resistance,AHA/IEC	C0
			VA018BCA-U	Grabber,20kΩ Resistance,AHA	C0
		Burdick PN:9293-04 2-50,XCLCCMD01A	VA018CCI	Grabber,20kΩ Resistance,IEC	C0

OEM Manufacturer & Models	Connector	OEM #	Order Code	Descriptions	Price
<b>Compatible Philips</b>					
Philips PageWriter TC10			VA066SFA	Snap,3.3kΩ Resistance,AHA	C9
			VA066SFI	Snap,3.3kΩ Resistance,IEC	C9
			VA066CFA	Grabber,3.3kΩ Resistance,AHA	C0
			VA066CFI	Grabber,3.3kΩ Resistance,IEC	C0
			VA066BFA	Banana,3.3kΩ Resistance,AHA	C0
		989803184921 989803184941	VA066BF	Banana,3.3kΩ Resistance,IEC	C0
			VA066NFA	Needle,3.3kΩ Resistance,AHA	C0
			VA066NFI	Needle,3.3kΩ Resistance,IEC	C0
Philips PageWriter TC20			VA065SBA	Snap,10kΩ Resistance,AHA	C9
			VA065SBI	Snap,10kΩ Resistance,IEC	C9
			VA065CBA	Grabber,10kΩ Resistance,AHA	C0
			VA065CBI	Grabber,10kΩ Resistance,IEC	C0
			VA065BBA	Banana,10kΩ Resistance,AHA	C0
		989803179441 989803175911	VA065BBI	Banana,10kΩ Resistance,IEC	C0
			VA065NBA	Needle,10kΩ Resistance,AHA	C0
			VA065NBI	Needle,10kΩ Resistance,IEC	C0







OEM Manufacturer & Models	Connector	OEM #	Order Code	Descriptions	Price
<b>Compatible Spacelabs</b>					
90367, 90369, 90496, 91496, Ultraview Module			VA027CBI	Grabber, 1 kΩ Resistance, IEC	F6
			VA027BBA	Banana, 1 kΩ Resistance, AHA	F6
		Sage P/N: A03-12S	VA027SBI	Snap, 1 kΩ Resistance, IEC	F5
<b>Compatible Schiller</b>					
Schiller: AT3, AT5, AT6, AT10, AT60, AT104 PC, AT104, AT101, CS6, CS12, CS100, CS200 Trentina : All Excel-Types			VA021BBA VA021BBI	Banana, 10kΩ Resistance, AHA/IEC	E4
			VA021BNA VA021BNI	Banana, No Resistance, AHA/IEC	D5
			VA021BDA VA021BDI	Banana, 10kΩ+SPD, AHA/IEC	F0
			VA021CBI	Grabber, 10kΩ Resistance, IEC	E4
			VA021CNI	Grabber, No Resistance, IEC	E2
			VA021SNI	Snap, No Resistance, IEC	E1
Schiller: AT-2 Plus, AT1, AT2, AT4, AT101, AT102 Datascope: BeneHeart R3 Esaote Biomedica: P80, P80Power, P80PowerSix		2.400095, 2400071E 2.400071S, MD07J	VA022BBA VA022BBI	Banana, 10kΩ Resistance, AHA/IEC	E4
		2.400116E	VA022CBI	Grabber, 10kΩ Resistance, IEC	E4
		2.400116S	VA022SBA	Snap, 10kΩ Resistance, AHA	E3
			VA022DBI	Din3.0, 10kΩ Resistance, IEC	E3
AT101, AT-2 Plus, AT1, AT2, AT4, AT102			98122841015	Din3.0, No Resistance, IEC	E0
<b>Compatible Trentina, Also See Compatible Schiller</b>					
All Excel-Types			VA031BNI	Banana, No Resistance, IEC	F2
			VA031CNI	Grabber, No Resistance, IEC	F2
			VA031SNI	Snap, No Resistance, IEC	F1
		See Compatible Schiller VA021 Series			
<b>Compatible ZOLL</b>					
E Series, M Series		8000-1007-02 8000-1007-01 8000-1006-02	VA034SBI	Snap, 10kΩ Resistance, IEC	F0
<b>Compatible Care Well</b>					
			VA077BNA	Banana, 10kΩ Resistance, AHA, 10ft	E4
			VA077BNI	Banana, 10kΩ Resistance, IEC, 10ft	E4



## 2 EKG Cable and LeadWires

### Product Features

1. Easy to replace leadwires;
2. Meeting the requirements of EC53;
3. Outstanding shielding property, Reduces the risk of Electromagnetic Interference (EMI);
4. Excellent defibrillation-proof performance, protecting the equipment well;
5. Flexible and durable cables;
6. Outstanding cable material, enduring repeated cleaning and disinfection;
7. Latex free.

OEM Manufacturer & Models	Instrument Connector	Yoke Connector	OEM #	Order Code	Descriptions	Pice
<b>Compatible GE Healthcare</b>						
GE Hellige: MicroSmart, MAC 500/1100/1200/1200 ST			22341 8-08	VE008-BAI	2.2m, 10kΩ resistance, AAMI/IEC fit for Multi-link (VS) style Lead Wires AS VE008BNI and VE008BNI	
CAM 14, CASE, MAC 5000, MAC 5500			20165 60- 001, 70065	VF008-N	EKG Trunk Cable 50in. (130cm)	
			7-001, E9001 YT	VF008-15	EKG Trunk Cable 15ft. (450cm)	
<b>Compatible Schiller/Trentina/Bionet (Korea)</b>						
Schiller: AT3, AT5, AT6, AT10, AT60, AT104 PC, AT104, CS6, CS12, CS100, CS200 Trentina: All Excel- Types;Bionet: All Excel- Types			700- 0008- 01	VE021-NAI	2.2m, no resistance, 10kΩ AAMI/IEC fit for Multi-link (VS) style Lead Wires AS VE008BNI, VE008CNA	
<b>Compatible Philips</b>						
XLI M1719A				V0018D	Philips DB9M Trunk Cable + Philips DB9M Trunk Cable, 8.5ft (260cm), 1pcs/pk	





## EKG LeadWires

### Product Features

1. Easy to replace trunk cables;
2. Meeting the requirements of EC53;
3. Outstanding shielding property, Reduces the risk of Electromagnetic Interference (EMI);
4. Flexible and durable cables;
5. Outstanding cable material, enduring repeated cleaning and disinfection;
6. Latex free.

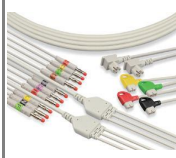
OEM Manufacturer & Models	Product Guide	OEM #	Order Code	Descriptions	Standard	Electrode End	Price
<b>Compatible CONMED/JINJIANG</b>							
Jinjiang Electronic Tech ,instrument: LEAD2000, GE electrophysiology machine			VG019SNA VG019SNI	10-Ld EKG LeadWires 4 x limb lead (130 cm) 6 x chest leads (70 cm),No Resistance	AHA/IEC	Snap	D5
<b>Compatible GE Healthcare</b>							
MAC 1000, MAC 1100, MAC 1200, MAC 1600, MAC 2000, MAC 3500, MAC 400, MAC 500, MAC 600, MAC 800, Microsmart M		38401816	VE008BNA	EKG LeadWires 4 x imb lead (130 cm), 6 x chest leads (70 cm) Twin Pin, Grouped, 2 sets, No Resistance	AHA	Banana	C5
			VE008BNI		IEC		
			VE008SNA	EKG LeadWires 4 x limb lead (130 cm),6 x chest leads (70 cm)Twin Pin, Grouped, 2 sets, No Resistance	AHA	Snap	C5
			VE008SNI		IEC		
			VE008CNI		IEC	Grabber (Clip)	C0
	GE Healthcare CAM14, CASE Series, MAC Series, CardioSmart, MicrosmartM		2104724-001	VE008BNA-10	Banana, AHA,No Resistance, Chest leads 32in,Limb leads 49in	AHA	Banana
2104751-001			VE008BNA-04	Banana, AHA, No Resistance Chest leads 32in,(E, H, M, I)	AHA	Banana	B0
CAM 14, CASE 8000, CASE Series, CardioSmart, CardioSoft, CardioSys, MAC 1100, MAC 1200, MAC 1600, MAC 3500, MAC 5000, MAC 5000ST, MAC 5500		E9006PJ	VE008A29	Leadwire,CAMUniversal,29in.(74 cm),6 pcs/pk, No Resistance			C4/pk
		E9006PK	VE008A40	Leadwire,CAM/Universal,40 in.(102 cm),6 pcs/pk, No Resistance			C4/pk
		E9006PL	VE008A51	Leadwire,CAMUniversal,51 in (130 cm),4 pcs/pk, No Resistance			C4/pk
		E9006PM	VE008A26	Leadwire,CAMUniversal,26 in.(66 cm),6 pcs/pk, No Resistance			C4/pk
		E9006PN	VE008A36	Leadwire,CAMUniversal,36 in.(90 cm),6 pcs/pk, No Resistance			C4/pk
<b>Compatible Mortara</b>							
AM12, Wireless Acqusion Module (WAM) Burdick: ELI 150C, ELI 230, ELI 250C, ELI 280, ELI 350		9293-041-50 9293-046-60	VT047BNA VT047BNI	12-Ld EKG LeadWires 4x limb lead (120 cm),6x chest leads (80 cm), No Resistance	AHA IEC	Banana	D5
		9293-047-60	VT047CNA VT047CNI	12-Ld EKG LeadWires 4x limb lead (120 cm),6x chest leads (80 cm), No Resistance	AHA IEC	Grabber (Clip)	D5
	VT047SNI VT047SNA						

OEM Manufacturer &	Product Guide	OEM #	Order Code	Descriptions	Standard	Electrode	Price
<b>Compatible Mortara</b>							
AM12, Wireless Acquisition Module (WAM) Burdick: ELI 150C, ELI 230, ELI 250C, ELI 280, ELI 350			VT047CBI	12-Ld EKG LeadWires 4 x limb lead (120 cm), 6 x chest leads (80cm), <b>with 10KΩ Resistance</b>	IEC	Grabber (Clip)	D5
<b>Compatible Philips</b>							
860306, 860310, 860315, PageWriter TC30/TC50/TC70		98980315163 1	VA051BNI	4 x limb lead (70 cm), 6 x chest leads (70 cm), <b>No Resistance</b>	IEC	Banana	D0
			VA051BNA	4 x limb lead (130cm), 6 x chest leads (72cm), <b>No Resistance</b>	AHA	Banana	D0
Philips CardioDynamics BioZ, M1701A, PageWriter PIM module - 989803130091, PageWriter PIM module - 989803130101, PageWriter TC70, PageWriter Trim I, PageWriter Trim II, PageWriter Trim III, PageWriter XLE 1702A, PageWriter XLi M1700A, Pagewriter Touch, Sonosite, Trim		98980312916 1	VX018BNA	4 x limb lead (130 cm), 6 x chest leads (80 cm), <b>No Resistance</b>	AHA	Banana	D5

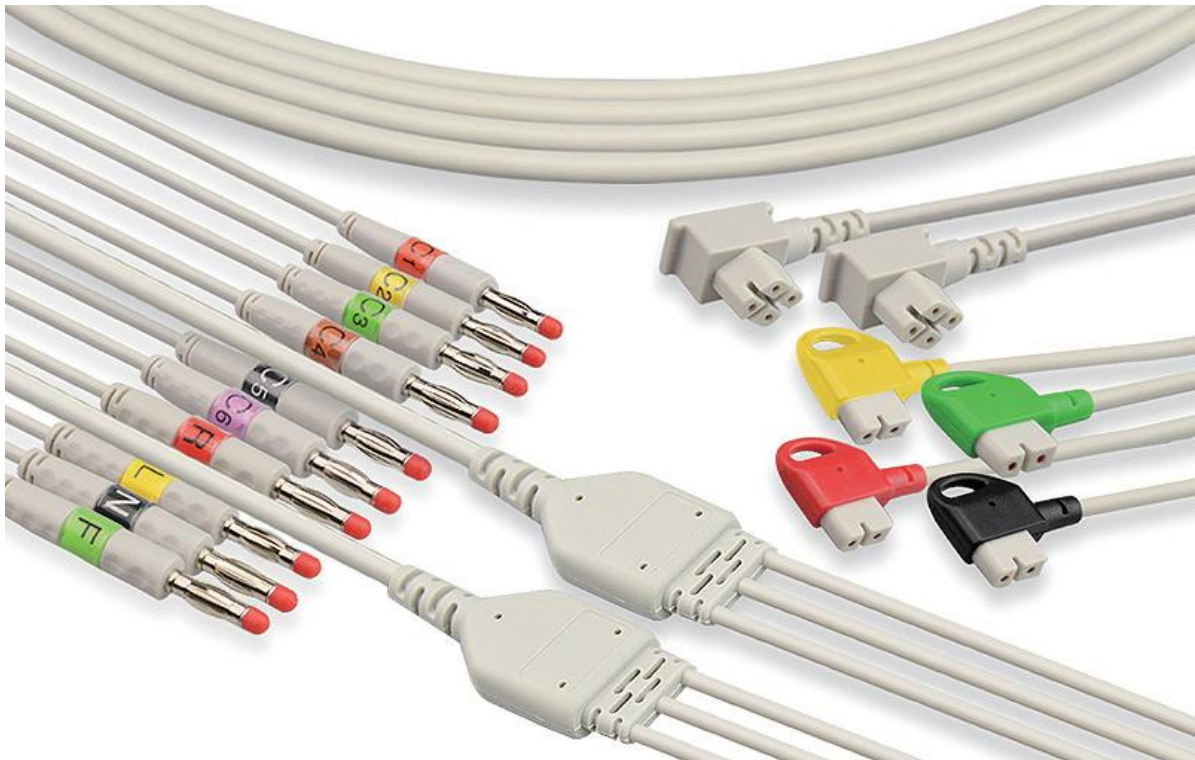















## 3 EKG Accessories





### Product Features

1. For adult and pediatric patients
2. Good biocompatibility, avoiding allergic reactions to patient
3. A variety of EKG machine adapters

OEM Manufacturer & Models	Product Guide	OEM #	Order Code	Descriptions	For People	Price
<b>Compatible Mortara</b>						
All Resting ECG Recommended for Nihon Kohden, GE, Philips		Nihon kohden: H043	V0013AB	<ol style="list-style-type: none"> <li>1. Diameter electrodes 21 mm. Bulb diameter is 26 mm.</li> <li>2. Metal Electrodes: Nickel-plate.</li> <li>3. Perfect fit for 3.0 mm Din plug or 4 mm banana plug.</li> <li>4. 1 box = 6 bulbs</li> </ol>	Adult	A0/box
All Resting ECG Recommended for Nihon Kohden, GE, Philips			V0013A-P	<ol style="list-style-type: none"> <li>1. Diameter electrodes 17 mm. Bulb diameter is 23 mm.</li> <li>2. Metal Electrodes: Nickel-plate.</li> <li>3. Perfect fit for 3.0 mm Din plug</li> <li>4. 1 box = 6 bulbs</li> </ol>	Paediatric	A0/box
All Resting ECG Recommended for GE-Marquette, Schiller, Mortala, Burdick, Philips		HP OEM ON: 40419A	V0013C-A	<ol style="list-style-type: none"> <li>1. Diameter electrodes 17 mm. Bulb diameter is 23 mm.</li> <li>2. Metal Electrodes: Nickel-plate.</li> <li>3. Perfect fit for 3.0 mm Din plug or 4 mm banana plug or (4 mm) Snap electrode</li> <li>4. 1 box = 6 bulbs</li> </ol>	Adult	B5/box
		HP OEM ON: 40422A	V0013C-P	<ol style="list-style-type: none"> <li>1. Diameter electrodes 17 mm. Bulb diameter is 23 mm. Bulb volume is 2cc</li> <li>2. Metal Electrodes: Nickel-plate.</li> <li>3. Perfect fit for 3.0 mm Din plug or 4 mm banana plug or (4 mm) Snap electrode</li> <li>4. 1 box = 6 bulbs</li> </ol>	Paediatric	B5/box
<b>Limb Clamp ECG Electrodes</b>						
All Resting ECG Recommended for Nihon Kohden, Fukuda, NEC, Kenz, China		Nihon kohden: H068K	V0012A	<ul style="list-style-type: none"> <li>- Perfect fit for 3.0 mm Din plug leads</li> <li>- Metal Electrodes: Nickel-plate.</li> <li>- 1 box = 4 electrodes</li> <li>- Color coding: IEC, red (R), yellow (L), black (RF), green (F)</li> </ul>	Multifunctional limb clamp	A8/box
			V0012B-I	<ul style="list-style-type: none"> <li>- Perfect fit for 4 mm banana plug</li> <li>- Metal Electrodes: Nickel-plate..</li> <li>- 1 box = 4 electrodes</li> <li>- Color coding: IEC, red(R), yellow (L), black (RF), green (F)</li> </ul>	Multifunctional limb clamp	A8/box

OEM Manufacturer & Models	Product Guide	OEM #	Order Code	Descriptions	For People	Price
<b>Limb Clamp ECG Electrodes</b>						
All Resting ECG Recommended for GE-Marquette, Schiller, Bionet, Mortala, Burdick		HP OEM ON: 40419A	V0012M-I	<ul style="list-style-type: none"> <li>– Perfect fit for 3.0 mm Din plug or 4 mm banana plug or (4 mm) <b>Snap</b></li> <li>– Metal Electrodes: Ag/AgCl</li> <li>– 1 box = 4 electrodes</li> <li>– Color coding : IEC, red (R), yellow (L), black (RF), green (F)</li> </ul>	Adult	B2/box
			V0012M-A	<ul style="list-style-type: none"> <li>– Perfect fit for 3.0 mm Din plug or 4 mm banana plug or (4 mm) <b>Snap</b> electrode</li> <li>– Metal Electrodes: Ag/AgCl</li> <li>– 1 box = 4 electrodes</li> <li>– Color coding : AHA, white (RA), black (LA), green (RL), red (LL)</li> </ul>	Adult	B3/box
All Resting ECG Recommended for GE-Marquette, Schiller, Bionet, Mortala, Burdick			V0012M-IP	<ul style="list-style-type: none"> <li>– Perfect fit for 3.0 mm Din plug or 4 mm banana plug or (4 mm) <b>Snap</b> electrodes</li> <li>– Metal Electrodes: Ag/AgCl</li> <li>– 1 box = 4 electrodes</li> <li>– Color coding : IEC, red (R), yellow (L), black (RF), green (F)</li> </ul>	Paediatric	B2/box
			V0012M-AP	<ul style="list-style-type: none"> <li>– Perfect fit for 3.0 mm Din plug or 4 mm banana plug or (4 mm) <b>Snap</b> Electrodes</li> <li>– Metal Electrodes: Ag/AgCl</li> <li>– 1 box = 4 electrodes</li> <li>– Color coding : AHA, white (RA), black (LA), green (RL), red (LL)</li> </ul>	Paediatric	B2/box
Applications	Product Guide	Order Code	Descriptions	Package	Price	
<b>Earth Cable</b>						
All patient monitor and cardiographs with standard Earth terminal			V0020A	<ul style="list-style-type: none"> <li>Earth Cable, 6 mm Jack &gt;&gt; Clip,</li> <li>– Length: 4000 mm</li> <li>– Wires type: UL 1015 14AWG 105° 600V</li> <li>– Color: yellow/green</li> </ul>	1 pcs/ bag	A7
			V0020B	<ul style="list-style-type: none"> <li>Earth Terminal, 6 mm diameter (perfect fit for 6 mm jack of V0020A)</li> <li>– Length: 30 mm</li> <li>– Metal terminal: Nickel-plate</li> </ul>	1 pcs/ bag	A1

Adapters Type	Productor Guide	Order Code	Descriptions	Package	Price
<b>Earth Cable</b>					
Grabber Adapters		V0010H	Adapter, 4mm with grabber end; Socket fit for 4mm Banana plug	10pcs/bag	B8
Snap Adapters		V0010G	Adapter, 4mm with Snap end; Socket fit for 4mm Banana plug	10pcs/bag	B8
Snap Adapters		V0010J	Snap to banana plug adapter (red) Socket fit for 4mm Banana plug	10pcs/bag	B8
Snap Adapters		V0010K	Snap to banana plug adapter (black) Socket fit for 4mm Banana plug	10pcs/bag	B8
Suitable for neonatal grabber ECG Electrode		V0010N	Adapter, 2.5mm with grabber end; Socket fit for 4mm Banana plug Length 0.38m (15in), black	10pcs/bag	F0

OEM Manufacturer & Models	Picture	Order Code	Descriptions (Name, Length, Patient end termination, Resistance)
<b>Lead Bead Markers</b>			
Lead Bead Markers Diameter range: 0.9mm~1.5mm		SL0373A	AAMI, 10pcs/pk, (RA, LA, RL, LL, V1, V2, V3, V4, V5, V6), Colour: White, Black, Green, Red, Red, Yellow, Green, Blue, Orange, Purple
		SL0373B	IEC, 10pcs/pk, (R, L, RF, F, C1, C2, C3, C4, C5, C6), Colour: Red, Yellow, Black, Green, Red, Yellow, Green, Brown, Black, Purple
		SL0373C	AAMI, 5pcs/pk, (Colour code: RA, LA, RL, LL, V), Colour: White, Black, Green, Red, Brown
		SL0373D	IEC, 5pcs/pk, (Colour code: R, L, RF, F, C), Colour: Red, Yellow, Black, Green, White)

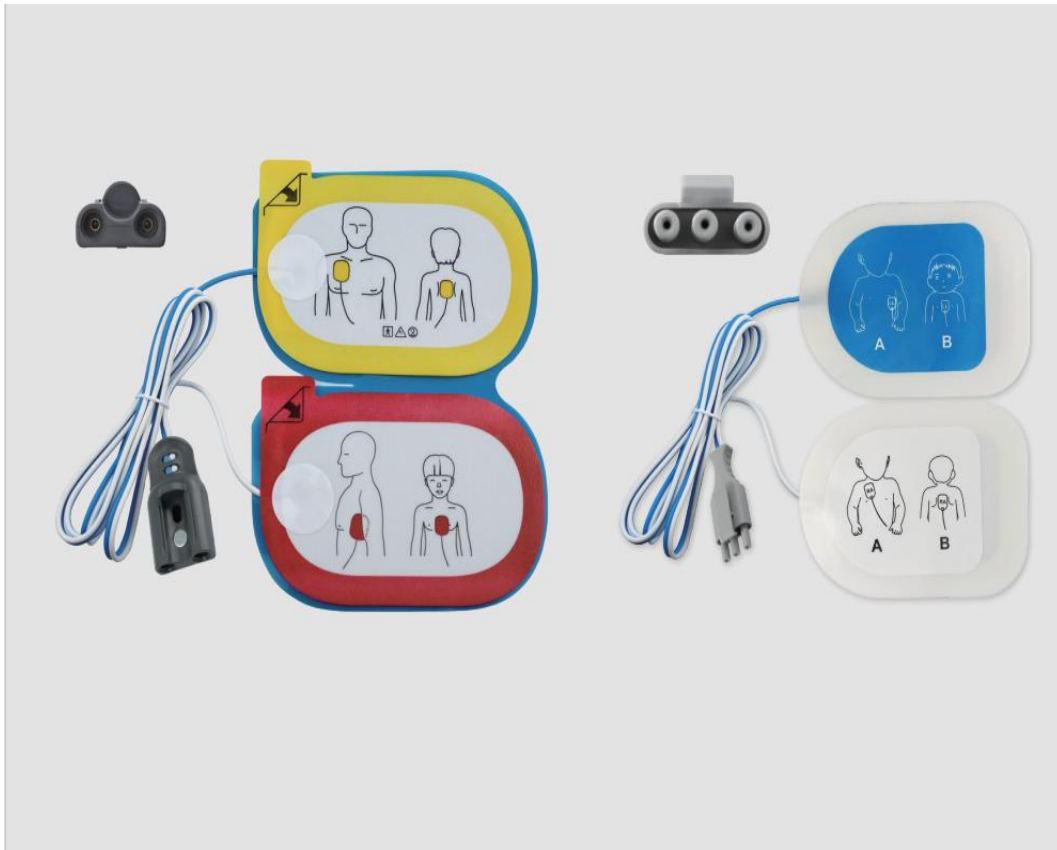

## 8 Disposable Defibrillation Pads

### Product Advantages

1. Integrates the functions of defibrillation, pacing, monitoring, and cardioversion.
2. The pre-connected cable saves time and helps quickly start the right therapy ,  
such as CPR or defibrillation.
3. The pads with color - coded operation indicators help to rapidly position and simplify the operation.
4. Low contact impedance to reduce skin burns.



### Suggested Applications

Defibrillation, pacing, monitoring, and cardioversion



## Disposable Defibrillation Pads

Compatible Models	Connector Pictures	OEM #	Order Code	Descriptions	Price
<b>CU Medical System</b> Paramedic CU-ER1 Paramedic CU-ER2 Paramedic CU-ER3 Paramedic CU-ER5 with ER-5 OA03 Adapter Cable Paramedic CU-ERT			DE0001A	Adult/Pediatric ≥ 25 kg, 1.2m	
			DE0001P	Pediatric or Infant <25kg, 1.2m	
<b>Medtronic Physio-Control</b> LIFEPAK 10/12/20/500/1000 <b>Osatu Bexen</b> REANIBEX-200/300/500/700/800 <b>Cardioline</b> ELIFE 700 <b>Mindray</b> BeneHeart D1/D2/D3/D5/D6		0651-30-77007 (Mindray)	DE0002A	Adult/Pediatric ≥ 25 kg, 1.2m	
			DE0002P	Pediatric or Infant <25kg, 1.2m	
<b>CMICS</b> AED-201 <b>RadianQbio</b> HR-501/503/501T/ 503T/701T/ 701T Plus			DE0003A	Adult/Pediatric ≥ 25 kg, 1.2m	
			DE0003P	Pediatric or Infant <25kg, 1.2m	
<b>CMOS DRAKE</b> Dea Life 400 Futura(after 2018) Cardioversor Vivo Gold (after 2024)		F7988/CM (CMOS DRAKE)	DE0004A	Adult/Pediatric ≥ 25 kg, 1.2m	
			DE0004P	Pediatric or Infant <25kg, 1.2m	
<b>CU Medical System</b> IPAD NF1200/1201 <b>Ambulanc</b> Amoul i3 Amoul i5 <b>CMOS DRAKE</b> Dea Life 400 Futura (before 2018) Cardioversor Vivo Gold (before 2024)		F7959/W (CMOS DRAKE)	DE0005A	Adult/Pediatric ≥ 25 kg, 1.2m	
			DE0005P	Pediatric or Infant <25kg, 1.2m	
<b>Zoll</b> PD1200/1400/1600/1700/2000 E Series M Series R Series <b>M&amp;B</b> AED7000			DE0006A	Adult/Pediatric ≥ 25 kg, 1.2m	
			DE0006P	Pediatric or Infant <25kg, 1.2m	
<b>Philips</b> 940010XX9400940020XX &9420XX &9400 M1722A/B M1723A/B M1724A M2475B/E/S/EM Series			DE0007A	Adult/Pediatric ≥ 25 kg, 1.2m	
			DE0007P	Pediatric or Infant <25kg, 1.2m	

## Disposable Defibrillation Pads

Compatible Models	Connector Pictures	OEM #	Order Code	Descriptions	Price
<b>Philips</b> HeartStart FR2/FR2+ HeartStart FR3 HeartStart FRx HeartStart XL+; M3508A plug connector cable HeartStart MRx; M3508A plug connector cable HeartStart Intrepid; M3508A plug connector cable Efficia DFM100; M3508A plug connector cable		M3713A	DE0008A	Adult/Pediatric ≥ 25 kg, 1.2m	
		M3717A, M3870A	DE0008P	Pediatric or Infant < 25kg, 1.2m	
<b>Nihon Kohden</b> AED-21XX series		H324B	DE0009A	Adult/Pediatric ≥ 25 kg, 1.2m	
			DE0009P	Pediatric or Infant < 25kg, 1.2m	
<b>Primedec</b> HeartSave PAD HeartSave AED HeartSave AED-M HeartSave 6 HeartSave 6S		96389	DE0010A	Adult/Pediatric ≥ 25 kg, 1.2m	
			DE0010P	Pediatric or Infant < 25kg, 1.2m	

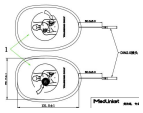
## Training Defibrillation Pads and Cables

Compatible Models	Pictures	OEM #	Order Code	Descriptions	Price
			160101001	Adult/Pediatric ≥ 25 kg, 0.05m	
<b>Medtronic Physio-Control</b> LIFEPAK 10/12/20/500/1000 <b>Osatu Bexen</b> REANIBEX-200/300/500/700/800 <b>Cardioline</b> ELIFE 700 <b>Mindray</b> BeneHeart D1/D2/D3/D5/D6			DC-DE-001	Adult/Pediatric, 1.2m, suitable for 160101001	
<b>CU Medical System</b> IPAD NF1200/1201 <b>Ambulanc</b> Amoul i3 Amoul i5 <b>CMOS DRAKE</b> Dea Life 400 Futura (before 2018) Cardioversor Vivo Gold (before 2024)			DC-DE-002	Adult/Pediatric, 1.2m, suitable for 160101001	







# Disposable ICG Electrode

## Product Features

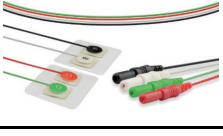
1. extra wide sensor site for enhanced impedance signal detection;
2. High quality conductive hydrogel with good adhesion to obtain better impedance signal.

**Med-linket offers single-use impedance sensors with the advantages of non-invasive infection risk and simple use for continuous monitoring, without the need for professional training. It is suitable for a wide range of brands and models of equipment in the hospital.**

OEM Manufacturer & Models	Product Guide	Order Code	Descriptions	Applicable Place	Price
A cardiac output monitor suitable for the ECG main cable of the Din-type splitter, such as Osypka		EC419-4I	4 LD, TPU Cable, 2.5 m	Anesthesiology, ICU, Operating room	
		V0014A-C0234I	Black Red Green White, 610 mm		
Non-invasive cardiac output monitor, hemodynamic monitor		COE0001N	DIN 1.5 Connector, 0.65m		
Impedance cardiac output measurement system		COE0002A	4.0mm button electrode, Adul, Foam, Wet gel		
		COE0003A	4.0mm button electrode, Adult,Foam,wet gel		



## NIBP Cuffs & Accessories

Medlinket blood pressure cuffs offer comprehensive programs that help reduce costs and enable workflow solutions in complex hospital environments-Reusable Blood Pressure Cuffs are an easy-to-use and affordable reusable solution, from neonate to adult patients, also supplied disposable cuffs to reduce the risk of cross-contamination. Also the Yellow cuffs are priced as single patient use and support your infection prevention protocols, while tailored for isolation area.



Instrument Socket	Plug to Monitor	Plug to Cuff	Air Hose Connector	NIBP Cuff
A17	A18	A06	A04	
A19	A06	A06	A05	
	A106	A30	A02	
	A29	A16	A26A26	
	A28	A119	A118	
	A54	A109	A108	
	A25	A11	A12	
	A40			
	A51	A12	A11A11	
	A24	A60	A65	
	A22	A34	A33A33	
	A47	A11A12	A11A12	
	A52			



# 1 Disposable NIBP Cuffs

## Product Features

1. Soft, absorbent material for maximum patient comfort
2. Strong enough for repeated inflations
3. Economical enough for single-patient use
4. Easy-to-use range markers and index line for proper size and placement
5. Latex free
6. FDA and CE approved

## Scope of Application

1. Operating Room (OR)
2. ICU
3. Neonatology
4. Internal Cardiovascular Dept.
5. Cardiothoracic Surgery Dept.
6. For patients prone to infection such as burns, open surgery, newborns, infectious diseases, etc.

## 1.1 Disposable Neonate NIBP Cuffs

### 1.1.1 Disposable NIBP Soft Fiber Cuffs with A26 Connector



Size #	Limb Circumference	Single Tube		Double Tube		Package	Price
		OEM #	Order Code	OEM #	Order Code		
1	3-6cm		Y000DSN1-1#		Y000DSN2-1#	24pcs/box	
2	4-8cm		Y000DSN1-2#		Y000DSN2-2#	24pcs/box	
3	6-11cm		Y000DSN1-3#		Y000DSN2-3#	24pcs/box	
4	7-14cm		Y000DSN1-4#		Y000DSN2-4#	24pcs/box	
5	8-15cm		Y000DSN1-5#		Y000DSN2-5#	24pcs/box	

### 1.1.3 Disposable NIBP Soft Fiber Cuffs with A79 Connector



Size #	Limb Circumference	Single Tube		Double Tube		Package	Price
		OEM #	Order Code	OEM #	Order Code		
1	3-6cm	5082-101-1	Y000DSN1-1#-A79	5082-101-2	Y000DSN2-1#-A79	24pcs/box	
2	4-8cm	5082-102-1	Y000DSN1-2#-A79	5082-102-2	Y000DSN2-2#-A79	24pcs/box	
3	6-11cm	5082-103-1	Y000DSN1-3#-A79	5082-103-2	Y000DSN2-3#-A79	24pcs/box	
4	7-14cm	5082-104-1	Y000DSN1-4#-A79	5082-104-2	Y000DSN2-4#-A79	24pcs/box	
5	8-15cm	5082-105-1	Y000DSN1-5#-A79	5082-105-2	Y000DSN2-5#-A79	24pcs/box	

1.1.4 Disposable NIBP Soft Fiber Cuffs with A65 Connector



Size #	Limb Circumference	Single Tube		Double Tube		Package	Price
		OEM #	Order Code	OEM #	Order Code		
1	3-6cm		Y000DSN1-1#-A65		Y000DSN2-1#-A65	24pcs/box	
2	4-8cm		Y000DSN1-2#-A65		Y000DSN2-2#-A65	24pcs/box	
3	6-11cm		Y000DSN1-3#-A65		Y000DSN2-3#-A65	24pcs/box	
4	7-14cm		Y000DSN1-4#-A65		Y000DSN2-4#-A65	24pcs/box	
5	8-15cm		Y000DSN1-5#-A65		Y000DSN2-5#-A65	24pcs/box	

1.1.5 Disposable NIBP Soft Fiber Cuffs with A12 Connector



Size #	Limb Circumference	Single Tube		Double Tube		Package	Price
		OEM #	Order Code	OEM #	Order Code		
1	3-6cm		Y000DSN1-1#-A12		Y000DSN2-1#-A12	24pcs/box	
2	4-8cm		Y000DSN1-2#-A12		Y000DSN2-2#-A12	24pcs/box	
3	6-11cm		Y000DSN1-3#-A12		Y000DSN2-3#-A12	24pcs/box	
4	7-14cm		Y000DSN1-4#-A12		Y000DSN2-4#-A12	24pcs/box	
5	8-15cm		Y000DSN1-5#-A12		Y000DSN2-5#-A12	24pcs/box	

1.1.6 Disposable NIBP Soft Fiber Cuffs with A09 Connector



Size #	Limb Circumference	Single Tube		Double Tube		Package	Price
		OEM #	Order Code	OEM #	Order Code		
1	3-6cm		Y000DSN1-1#-A09		Y000DSN2-1#-A09	24pcs/box	
2	4-8cm		Y000DSN1-2#-A09		Y000DSN2-2#-A09	24pcs/box	
3	6-11cm		Y000DSN1-3#-A09		Y000DSN2-3#-A09	24pcs/box	
4	7-14cm		Y000DSN1-4#-A09		Y000DSN2-4#-A09	24pcs/box	
5	8-15cm		Y000DSN1-5#-A09		Y000DSN2-5#-A09	24pcs/box	

1.1.7 Disposable NIBP Soft Fiber Cuffs with A11A12 Connector



Size #	Limb Circumference	Double Tube		Package	Price
		OEM #	Order Code		
1	3-6cm		Y000DSN2-1#-A11A12	24pcs/box	
2	4-8cm		Y000DSN2-2#-A11A12	24pcs/box	
3	6-11cm		Y000DSN2-3#-A11A12	24pcs/box	
4	7-14cm		Y000DSN2-4#-A11A12	24pcs/box	
5	8-15cm		Y000DSN2-5#-A11A12	24pcs/box	

1.1.8 Hylink Disposable NIBP Comfort Cuffs with A26 Connector



Size #	Limb Circumference	Single Tube		Double Tube		Package	Price
		OEM #	Order Code	OEM #	Order Code		
1	3-6cm	5082-101-1	98230301026	5082-101-2	98232301026	24pcs/box	
2	4-8cm	5082-102-1	98230302026	5082-102-2	98232302026	24pcs/box	
3	6-11cm	5082-103-1	98230303026	5082-103-2	98232303026	24pcs/box	
4	7-14cm	5082-104-1	98230304026	5082-104-2	98232304026	24pcs/box	
5	8-15cm	5082-105-1	98230305026	5082-105-2	98232305026	24pcs/box	

1.1.10 Hylink Disposable NIBP Comfort Cuffs with A05 Connector



Size #	Limb Circumference	Single Tube		Double Tube		Package	Price
		OEM #	Order Code	OEM #	Order Code		
1	3-6cm		98230301005		98232301005	24pcs/box	
2	4-8cm		98230302005		98232302005	24pcs/box	
3	6-11cm		98230303005		98232303005	24pcs/box	
4	7-14cm		98230304005		98232304005	24pcs/box	
5	8-15cm		98230305005		98232305005	24pcs/box	

1.1.11 Hylink Disposable NIBP Comfort Cuffs with A65 Connector



Size #	Limb Circumference	Single Tube		Double Tube		Package	Price
		OEM #	Order Code	OEM #	Order Code		
1	3-6cm		98230301065		98232301065	24pcs/box	
2	4-8cm		98230302065		98232302065	24pcs/box	
3	6-11cm		98230303065		98232303065	24pcs/box	
4	7-14cm		98230304065		98232304065	24pcs/box	
5	8-15cm		98230305065		98232305065	24pcs/box	

## 1.2 Disposable NIBP Cuffs



### 1.2.1 Disposable NIBP Comfort Cuffs (Single Tube)

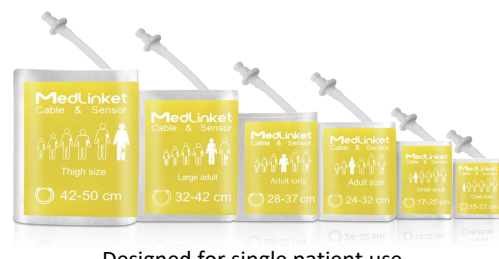

Non-woven Series





Designed for single patient use within an isolation environment

Patient Size	Limb Circumference	Order Code (Single Tube)		Cuff Connector	Compatible Patient Monitor	Package	Price
		Non-woven Series	Tailored for isolation area environment				
Adult thigh	42-54cm	Y000DT1	Y006DT1			10pcs/box	
Large adult	32-42cm	Y000DLA1	Y006DLA1			10pcs/box	
Adult long	28-37cm	Y000DAL1	Y006DAL1			10pcs/box	
Adult	24-32cm	Y000DA1	Y006DA1			10pcs/box	
Small adult	17-25cm	Y000DSA1	Y006DSA1			10pcs/box	
Pediatric	15-22cm	Y000DC1	Y006DC1			10pcs/box	
Adult thigh	42-54cm	Y000DT1-A05	Y006DT1-A05				Philips Mindray Spacelabs
Large adult	32-42cm	Y000DLA1-A05	Y006DLA1-A05	10pcs/box			
Adult long	28-37cm	Y000DAL1-A05	Y006DAL1-A05	10pcs/box			
Adult	24-32cm	Y000DA1-A05	Y006DA1-A05	10pcs/box			
Small adult	17-25cm	Y000DSA1-A05	Y006DSA1-A05	10pcs/box			
Pediatric	15-22cm	Y000DC1-A05	Y006DC1-A05	10pcs/box			
Adult thigh	42-54cm	Y000DT1-A118	Y006DT1-A118		Drager Siemens	10pcs/box	
Large adult	32-42cm	Y000DLA1-A118	Y006DLA1-A118			10pcs/box	
Adult long	28-37cm	Y000DAL1-A118	Y006DAL1-A118			10pcs/box	
Adult	24-32cm	Y000DA1-A118	Y006DA1-A118			10pcs/box	
Small adult	17-25cm	Y000DSA1-A118	Y006DSA1-A118			10pcs/box	
Pediatric	15-22cm	Y000DC1-A118	Y006DC1-A118			10pcs/box	
Adult thigh	42-54cm	Y000DT1-A12	Y006DT1-A12		Nihon Kohden	10pcs/box	
Large adult	32-42cm	Y000DLA1-A12	Y006DLA1-A12			10pcs/box	
Adult long	28-37cm	Y000DAL1-A12	Y006DAL1-A12			10pcs/box	
Adult	24-32cm	Y000DA1-A12	Y006DA1-A12			10pcs/box	
Small adult	17-25cm	Y000DSA1-A12	Y006DSA1-A12			10pcs/box	
Pediatric	15-22cm	Y000DC1-A12	Y006DC1-A12			10pcs/box	
Adult thigh	42-54cm	Y000DT1-A09	Y006DT1-A09		GE Welch Allyn	10pcs/box	
Large adult	32-42cm	Y000DLA1-A09	Y006DLA1-A09			10pcs/box	
Adult long	28-37cm	Y000DAL1-A09	Y006DAL1-A09			10pcs/box	
Adult	24-32cm	Y000DA1-A09	Y006DA1-A09			10pcs/box	
Small adult	17-25cm	Y000DSA1-A09	Y006DSA1-A09			10pcs/box	
Pediatric	15-22cm	Y000DC1-A09	Y006DC1-A09			10pcs/box	
Adult thigh	42-54cm	Y000DT1-A11	Y006DT1-A11		GE Datex ohmeda	10pcs/box	
Large adult	32-42cm	Y000DLA1-A11	Y006DLA1-A11			10pcs/box	
Adult long	28-37cm	Y000DAL1-A11	Y006DAL1-A11			10pcs/box	
Adult	24-32cm	Y000DA1-A11	Y006DA1-A11			10pcs/box	
Small adult	17-25cm	Y000DSA1-A11	Y006DSA1-A11			10pcs/box	
Pediatric	15-22cm	Y000DC1-A11	Y006DC1-A11			10pcs/box	

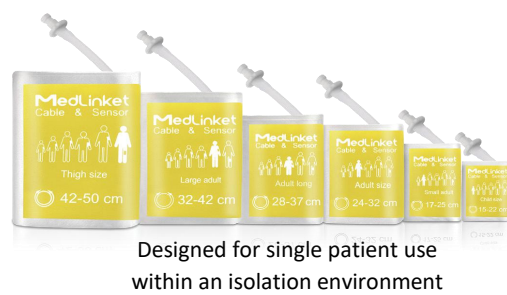
### 1.2.2 Disposable NIBP Comfort Cuffs (Double Tube)



Patient Size	Limb Circumference	Order Code (Single Tube)		Cuff Connector	Compatible Patient Monitor	Package	Price
		Non-woven Series	Tailored for isolation area environment				
Adult thigh	42-54cm	Y000DT2	Y006DT2			10pcs/box	
Large adult	32-42cm	Y000DLA2	Y006DLA2			10pcs/box	
Adult long	28-37cm	Y000DAL2	Y006DAL2			10pcs/box	
Adult	24-32cm	Y000DA2	Y006DA2			10pcs/box	
Small adult	17-25cm	Y000DSA2	Y006DSA2			10pcs/box	
Pediatric	15-22cm	Y000DC2	Y006DC2			10pcs/box	
Adult thigh	42-54cm	Y000DT2-A09	Y006DT2-A09		GE Corometrics GE Dianmap	10pcs/box	
Large adult	32-42cm	Y000DLA2-A09	Y006DLA2-A09			10pcs/box	
Adult long	28-37cm	Y000DAL2-A09	Y006DAL2-A09			10pcs/box	
Adult	24-32cm	Y000DA2-A09	Y006DA2-A09			10pcs/box	
Small adult	17-25cm	Y000DSA2-A09	Y006DSA2-A09			10pcs/box	
Pediatric	15-22cm	Y000DC2-A09	Y006DC2-A09			10pcs/box	
Adult thigh	42-54cm	Y000DT2-A108	Y006DT2-A108		GE	10pcs/box	
Large adult	32-42cm	Y000DLA2-A108	Y006DLA2-A108			10pcs/box	
Adult long	28-37cm	Y000DAL2-A108	Y006DAL2-A108			10pcs/box	
Adult	24-32cm	Y000DA2-A108	Y006DA2-A108			10pcs/box	
Small adult	17-25cm	Y000DSA2-A108	Y006DSA2-A108			10pcs/box	
Pediatric	15-22cm	Y000DC2-A108	Y006DC2-A108			10pcs/box	
Adult thigh	42-54cm	Y000DT2-A11	Y006DT2-A11		GE Datex ohmeda	10pcs/box	
Large adult	32-42cm	Y000DLA2-A11	Y006DLA2-A11			10pcs/box	
Adult long	28-37cm	Y000DAL2-A11	Y006DAL2-A11			10pcs/box	
Adult	24-32cm	Y000DA2-A11	Y006DA2-A11			10pcs/box	
Small adult	17-25cm	Y000DSA2-A11	Y006DSA2-A11			10pcs/box	
Pediatric	15-22cm	Y000DC2-A11	Y006DC2-A11			10pcs/box	
Adult thigh	42-54cm	Y000DT2-A12	Y006DT2-A12		Nihon Kohden	10pcs/box	
Large adult	32-42cm	Y000DLA2-A12	Y006DLA2-A12			10pcs/box	
Adult long	28-37cm	Y000DAL2-A12	Y006DAL2-A12			10pcs/box	
Adult	24-32cm	Y000DA2-A12	Y006DA2-A12			10pcs/box	
Small adult	17-25cm	Y000DSA2-A12	Y006DSA2-A12			10pcs/box	
Pediatric	15-22cm	Y000DC2-A12	Y006DC2-A12			10pcs/box	
Adult thigh	42-54cm	Y000DT2-A11A12	Y006DT2-A11A12		GE Eagle/Dash/ Tram/Solar	10pcs/box	
Large adult	32-42cm	Y000DLA2-A11A12	Y006DLA2-A11A12			10pcs/box	
Adult long	28-37cm	Y000DAL2-A11A12	Y006DAL2-A11A12			10pcs/box	
Adult	24-32cm	Y000DA2-A11A12	Y006DA2-A11A12			10pcs/box	
Small adult	17-25cm	Y000DSA2-A11A12	Y006DSA2-A11A12			10pcs/box	
Pediatric	15-22cm	Y000DC2-A11A12	Y006DC2-A11A12			10pcs/box	

Patient Size	Limb Circumference	Order Code (Single Tube)		Cuff Connector	Compatible Patient Monitor	Package	Price
		Non-woven Series	Tailored for isolation area environment				
Adult thigh	42-54cm	Y000DT2-A05	Y006DT2-A05		Philips Mindray Spacelabs	10pcs/box	
Large adult	32-42cm	Y000DLA2-A05	Y006DLA2-A05			10pcs/box	
Adult long	28-37cm	Y000DAL2-A05	Y006DAL2-A05			10pcs/box	
Adult	24-32cm	Y000DA2-A05	Y006DA2-A05			10pcs/box	
Small adult	17-25cm	Y000DSA2-A05	Y006DSA2-A05			10pcs/box	
Pediatric	15-22cm	Y000DC2-A05	Y006DC2-A05			10pcs/box	
Adult thigh	42-54cm	Y000DT2-A118	Y006DT2-A118		Dräger Siemens	10pcs/box	
Large adult	32-42cm	Y000DLA2-A118	Y006DLA2-A118			10pcs/box	
Adult long	28-37cm	Y000DAL2-A118	Y006DAL2-A118			10pcs/box	
Adult	24-32cm	Y000DA2-A118	Y006DA2-A118			10pcs/box	
Small adult	17-25cm	Y000DSA2-A118	Y006DSA2-A118			10pcs/box	
Pediatric	15-22cm	Y000DC2-A118	Y006DC2-A118			10pcs/box	



## 2 Reusable NIBP Cuffs

### Code Rule Description

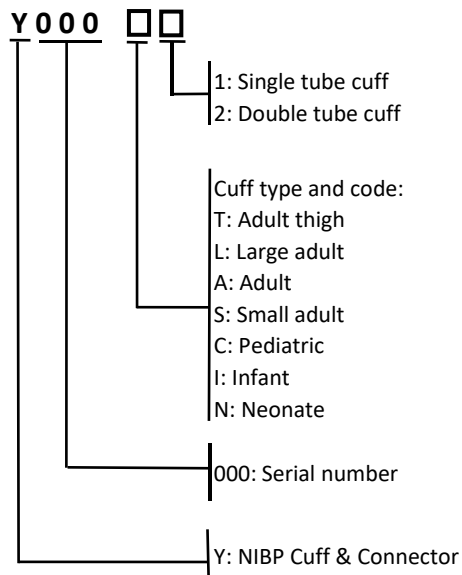

### Product Features

1. Gentle nylon and TPU materials cuff;
2. Soft and comfortable, low hazard to skin even if a long-term use;
3. Easy to clean, no bladder, can be cleaned and disinfected directly;
4. TPU bladder ensures good air tightness and long life;
5. Variety of connectors to fit all mainstream monitoring systems;
6. Easy-to-use range markers and index line for proper size and placement;
7. Latex free, PVC free;
8. Good biocompatibility, free from biological hazard to skin.

## 1.1 Reusable NIBP Bladder Cuffs





### Main Features

1. Soft and comfortable, skin friendly, suitable for continuous monitoring;
2. TPU bladder ensures good air tightness and durability.

### Scope of Application

For ICU, General inpatient dept.

#### 1.1.1 Reusable NIBP Bladder Cuffs (Single Tube)

Patient Size	Limb Circumference	Order Code (Single Tube)	Cuff Connector	Compatible Patient Monitor	Package	Price
Adult thigh	42-54cm	Y000T1	Without connector	/	1pc/bag	A0
Large adult	34-43cm	Y000L1				A0
Large adult Long	34-43cm	Y000LL1				A0
Adult	27-35cm	Y000A1				A7
Small adult	20.5-28cm	Y000S1				A7
Pediatric	14-21.5cm	Y000C1				A6
Infant	10-15cm	Y000I1				A6
Neonate	6-11cm	Y000N1				A6
Adult thigh	42-54cm	Y000T1-A04		Philips Mindray Spacelabs Siemens Colin	1pc/bag	B2
Large adult	34-43cm	Y000L1-A04				B2
Adult	27-35cm	Y000A1-A04				A8
Small adult	20.5-28cm	Y000S1-A04				A8
Pediatric	14-21.5cm	Y000C1-A04				A7
Infant	10-15cm	Y000I1-A04				A7
Neonate	6-11cm	Y000N1-A04				A7
Adult thigh	42-54cm	98210311004				
Large adult	34-43cm	98210310004	B2			
Adult	27-35cm	98210308004	A8			
Small adult	20.5-28cm	98210307004	A8			
Pediatric	14-21.5cm	98210306004	A7			
Infant	10-15cm	98210305004	A7			
Neonate	6-11cm	98210303004	A7			







### 1.1.1 Reusable NIBP Bladder Cuffs (Single Tube)

Patient Size	Limb Circumference	Order Code (Single Tube)	Cuff Connector	Compatible Patient Monitor	Package	Price
Adult thigh	42-54cm	Y000T1-A05		Philips Mindray Spacelabs	1pc/bag	B2
Large adult	34-43cm	Y000L1-A05				B2
Adult	27-35cm	Y000A1-A05				A8
Small adult	20.5-28cm	Y000S1-A05				A8
Pediatric	14-21.5cm	Y000C1-A05				A7
Infant	10-15cm	Y000I1-A05				A7
Neonate	6-11cm	Y000N1-A05				A7
Adult thigh	42-54cm	Y000T1-A12		Nihon Kohden	1pc/bag	B2
Large adult	34-43cm	Y000L1-A12				B2
Adult	27-35cm	Y000A1-A12				A8
Small adult	20.5-28cm	Y000S1-A12				A8
Pediatric	14-21.5cm	Y000C1-A12				A7
Infant	10-15cm	Y000I1-A12				A7
Neonate	6-11cm	Y000N1-A12				A7
Adult thigh	42-54cm	Y000T1-A118		Drager Siemens	1pc/bag	B2
Large adult	34-43cm	Y000L1-A118				B2
Adult	27-35cm	Y000A1-A118				A8
Small adult	20.5-28cm	Y000S1-A118				A8
Pediatric	14-21.5cm	Y000C1-A118				A7
Infant	10-15cm	Y000I1-A118				A7
Neonate	6-11cm	Y000N1-A118				A7
Adult thigh	42-54cm	Y000T1-A11		Welch Allyn	1pc/bag	B2
Large adult	34-43cm	Y000L1-A11				B2
Adult	27-35cm	Y000A1-A11				A8
Small adult	20.5-28cm	Y000S1-A11				A8
Pediatric	14-21.5cm	Y000C1-A11				A7
Infant	10-15cm	Y000I1-A11				A7
Neonate	6-11cm	Y000N1-A11				A7

### 1.1.2 Reusable NIBP Bladder Cuffs (Double Tube)

Patient Size	Limb Circumference	Order Code (Double Tube)	Cuff Connector	Compatible Patient Monitor	Package	Price
Adult thigh	42-54cm	Y000T2	Without connector	/	1pc/bag	A0
Large adult	34-43cm	Y000L2				A0
Adult	27-35cm	Y000A2				A7
Small adult	20.5-28cm	Y000S2				A7
Pediatric	14-21.5cm	Y000C2				A6
Infant	10-15cm	Y000I2				A6
Neonate	6-11cm	Y000N2				A6

### 1.1.2 Reusable NIBP Bladder Cuffs (Double Tube)

Patient Size	Limb Circumference	Order Code (Double Tube)	Cuff Connector	Compatible Patient Monitor	Package	Price
Adult thigh	42-54cm	Y000T2-A108		GE	1pc/bag	B2
Large adult	34-43cm	Y000L2-A108				B2
Adult	27-35cm	Y000A2-A108				A8
Small adult	20.5-28cm	Y000S2-A108				A8
Pediatric	14-21.5cm	Y000C2-A108				A7
Infant	10-15cm	Y000I2-A108				A7
Neonate	6-11cm	Y000N2-A108				A7
Adult thigh	42-54cm	Y000T2-A11		/	1pc/bag	B2
Large adult	34-43cm	Y000L2-A11				B2
Adult	27-35cm	Y000A2-A11				A8
Small adult	20.5-28cm	Y000S2-A11				A8
Pediatric	14-21.5cm	Y000C2-A11				A7
Infant	10-15cm	Y000I2-A11				A7
Neonate	6-11cm	Y000N2-A11				A7
Adult thigh	42-54cm	Y000T2-A12		/	1pc/bag	B2
Large adult	34-43cm	Y000L2-A12				B2
Adult	27-35cm	Y000A2-A12				A8
Small adult	20.5-28cm	Y000S2-A12				A8
Pediatric	14-21.5cm	Y000C2-A12				A7
Infant	10-15cm	Y000I2-A12				A7
Neonate	6-11cm	Y000N2-A12				A7
Adult thigh	42-54cm	Y000T2-A11A12		GE Eagle/Dash/Tram/Solar	1pc/bag	B2
Large adult	34-43cm	Y000L2-A11A12				B2
Adult	27-35cm	Y000A2-A11A12				A8
Small adult	20.5-28cm	Y000S2-A11A12				A8
Pediatric	14-21.5cm	Y000C2-A11A12				A7
Infant	10-15cm	Y000I2-A11A12				A7
Neonate	6-11cm	Y000N2-A11A12				A7
Adult thigh	42-54cm	Y000T2-A09		GE Corometrics GE Dianmap	1pc/bag	B2
Large adult	34-43cm	Y000L2-A09				B2
Adult	27-35cm	Y000A2-A09				A8
Small adult	20.5-28cm	Y000S2-A09				A8
Pediatric	14-21.5cm	Y000C2-A09				A7
Infant	10-15cm	Y000I2-A09				A7
Neonate	6-11cm	Y000N2-A09				A7
Adult thigh	42-54cm	Y000T2-A05		Philips Siemens Datascope Colin	1pc/bag	B2
Large adult	34-43cm	Y000L2-A05				B2
Adult	27-35cm	Y000A2-A05				A8
Small adult	20.5-28cm	Y000S2-A05				A8
Pediatric	14-21.5cm	Y000C2-A05				A7
Infant	10-15cm	Y000I2-A05				A7
Neonate	6-11cm	Y000N2-A05				A7

## 1.2 Reusable NIBP Bladderless Cuffs



### Main Features

1. Easy to clean and durable, No bladder, can be cleaned and disinfected directly;
2. Suitable for spot testing, ward round, short time monitoring, places easy to stick blood (such as emergencies).

### Scope of Application

1. Outpatient Dept.
2. Emergency Dept. (ER)

### 1.2.1 Reusable NIBP Bladderless Cuffs (Single Tube)

Patient Size	Limb Circumference	Order Code (Single Tube)	Cuff Connector	Compatible Patient Monitor	Package	Price
Adult thigh	42-50cm	Y000RT1	Without connector	/	1pc/bag	A0
Large adult	32-42cm	Y000RLA1				A7
Adult long	28-37cm	Y000RAL1				A7
Adult	24-32cm	Y000RA1				A6
Small adult	17-25cm	Y000RSA1				A0
Pediatric	15-22cm	Y000RC1				A0
Large Adult thigh	42-54cm	Y000RTL1-A04				
Adult thigh	42-50cm	Y000RT1-A04	B2			
Large adult	32-42cm	Y000RLA1-A04	B2			
Adult long	28-37cm	Y000RAL1-A04	B2			
Adult	24-32cm	Y000RA1-A04	A8			
Small adult	17-25cm	Y000RSA1-A04	A8			
Pediatric	15-22cm	Y000RC1-A04	A7			
Infant	10-15cm	Y000RI1-A04	A7			

### 1.2.1 Reusable NIBP Bladderless Cuffs (Single Tube)

Patient Size	Limb Circumference	Order Code (Single Tube)	Cuff Connector	Compatible Patient Monitor	Package	Price
Adult thigh	42-54cm	Y000RTL1-A05		Philips Mindray Spacelabs	1pc/bag	B2
Adult thigh	42-50cm	Y000RT1-A05				B2
Large adult	32-42cm	Y000RLA1-A05				B2
Adult long	28-37cm	Y000RAL1-A05				B2
Adult	24-32cm	Y000RA1-A05				A8
Small adult	17-25cm	Y000RSA1-A05				A8
Pediatric	15-22cm	Y000RC1-A05				A7
Infan	10-15cm	Y000RI1-A05				A7
Adult thigh	42-50cm	Y000RT1-A12		Nihon Kohden	1pc/bag	B2
Large adult	32-42cm	Y000RLA1-A12				B2
Adult long	28-37cm	Y000RAL1-A12				B2
Adult	24-32cm	Y000RA1-A12				A8
Small adult	17-25cm	Y000RSA1-A12				A8
Pediatric	15-22cm	Y000RC1-A12				A7
Infant	10-15cm	Y000RI1-A12				A7
Adult thigh	42-50cm	Y000RT1-A118		Drager Siemens	1pc/bag	B2
Large adult	32-42cm	Y000RLA1-A118				B2
Adult long	28-37cm	Y000RAL1-A118				B2
Adult	24-32cm	Y000RA1-A118				A8
Small adult	17-25cm	Y000RSA1-A118				A8
Pediatric	15-22cm	Y000RC1-A118				A7
Infant	10-15cm	Y000RI1-A118				A7
Adult thigh	42-50cm	Y000RT1-A11		Welch Allyn	1pc/bag	B2
Large adult	32-42cm	Y000RLA1-A11				B2
Adult long	28-37cm	Y000RAL1-A11				B2
Adult	24-32cm	Y000RA1-A11				A8
Small adult	17-25cm	Y000RSA1-A11				A8
Pediatric	15-22cm	Y000RC1-A11				A7
Infant	10-15cm	Y000RI1-A11				A7

### 1.2.2 Reusable NIBP Bladderless Cuffs (Double Tube)

Patient Size	Limb Circumference	Order Code (Double Tube)	Cuff Connector	Compatible Patient Monitor	Package	Price
Adult thigh	42-50cm	Y000RT2	Without connector	/	1pc/bag	A0
Large adult	32-42cm	Y000RLA2				A0
Adult long	28-37cm	Y000RAL2				A0
Adult	24-32cm	Y000RA2				A7
Small adult	17-25cm	Y000RSA2				A7
Pediatric	15-22cm	Y000RC2				A6

## 1.2.1 Reusable NIBP Bladderless Cuffs (Double Tube)

Patient Size	Limb Circumference	Order Code ( Double Tube)	Cuff Connector	Compatible Patient Monitor	Package	Price
Adult thigh	42-50cm	Y000RT2-A108		GE	1pc/bag	B2
Large adult	32-42cm	Y000RLA2-A108				B2
Adult long	28-37cm	Y000RAL2-A108				B2
Adult	24-32cm	Y000RA2-A108				A8
Small adult	17-25cm	Y000RSA2-A108				A8
Pediatric	15-22cm	Y000RC2-A108				A7
Infant	10-15cm	Y000RI2-A108				A7
Adult thigh	42-50cm	Y000RT2-A11		/	1pc/bag	B2
Large adult	32-42cm	Y000RLA2-A11				B2
Adult long	28-37cm	Y000RAL2-A11				B2
Adult	24-32cm	Y000RA2-A11				A8
Small adult	17-25cm	Y000RSA2-A11				A8
Pediatric	15-22cm	Y000RC2-A11				A7
Infant	10-15cm	Y000RI2-A11				A7
Adult thigh	42-50cm	Y000RT2-A12		/	1pc/bag	B2
Large adult	32-42cm	Y000RLA2-A12				B2
Adult long	28-37cm	Y000RAL2-A12				B2
Adult	24-32cm	Y000RA2-A12				A8
Small adult	17-25cm	Y000RSA2-A12				A8
Pediatric	15-22cm	Y000RC2-A12				A7
Infant	10-15cm	Y000RI2-A12				A7
Adult thigh	42-50cm	Y000RT2-A11A12		GE Eagle/Dash/ Tram/Solar	1pc/bag	B2
Large adult	32-42cm	Y000RLA2-A11A12				B2
Adult long	28-37cm	Y000RAL2-A11A12				B2
Adult	24-32cm	Y000RA2-A11A12				A8
Small adult	17-25cm	Y000RSA2-A11A12				A8
Pediatric	15-22cm	Y000RC2-A11A12				A7
Infant	10-15cm	Y000RI2-A11A12				A7
Adult thigh	42-50cm	Y000RT2-A09		GE Corometrics GE Dianmap	1pc/bag	B2
Large adult	32-42cm	Y000RLA2-A09				B2
Adult long	28-37cm	Y000RAL2-A09				B2
Adult	24-32cm	Y000RA2-A09				A8
Small adult	17-25cm	Y000RSA2-A09				A8
Pediatric	15-22cm	Y000RC2-A09				A7
Infant	10-15cm	Y000RI2-A09				A7

### 2.3.1 Reusable NIBP Bladderless Cuffs (Single Tube)

Patient Size	Limb Circumference	Order Code (Single Tube)	Cuff Connector	Compatible Patient Monitor	Package	Price
Adult thigh	42-54cm	Y008T1	Without connector	/	1pc/bag	A9
Large adult	32-42cm	Y008LA1				A9
Adult long	28-37cm	Y0008AL1				A9
Adult	24-32cm	Y0008A1				A6
Small adult	17-25cm	Y0008SA1				A6
Pediatric	15-22cm	Y0008C1				A5

### 2.3.2 Reusable NIBP Bladderless Cuffs (Double Tube)



Patient Size	Limb Circumference	Order Code (Double Tube)	Cuff Connector	Compatible Patient Monitor	Package	Price
Adult thigh	42-54cm	Y008T2	Without connector	/	1pc/bag	A9
Large adult	32-42cm	Y008LA2				A9
Adult long	28-37cm	Y008AL2				A9
Adult	24-32cm	Y008A2				A6
Small adult	17-25cm	Y008SA2				A6
Pediatric	15-22cm	Y008C2				A5



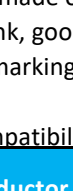

## 3 Household NIBP Cuffs

### Product Features

1. The jacket is made of nylon fabric, which is soft, skin-friendly and comfortable;
2. TPU inner tank, good air tightness, accurate test and long service life;
3. Clear range markings and operating steps for easy selection of the appropriate cuff and ease of use;
4. Good biocompatibility, latex free, avoid allergic reactions to patients.

OEM Manufacturer & Models	Product Picture	Patient Size	Limb Circumference	Order Code	Descriptions	Price	
Omron Series 5, Yuyue 660, 670, 680, 690 Series		Adult thigh	42-53CM	Y003T1-A62	Single tube, trachea length:67cm, nylon fabric		
				Y003T1			
		Adult	22-32cm	Y003A1-A62	Single tube, trachea length:62cm, nylon fabric		
				Y003A1			
		Large Adult	32-45cm	Y003L1-A62	Single tube, trachea length:62cm, nylon fabric		
				Y003L1			
		Adult	22-42cm	Y003LA-A62	Single tube, trachea length:62cm, nylon fabric		
				Y003LA			
			Pediatric	17-22CM	Y003C1-A62	Single tube, trachea length:39cm, nylon fabric	
					Y003C1		

### YA84 OMRON connector set, contains the following connectors



A72		Length: 31.75mm, ABS, φ6mm	A74		Length: 30.92m m, ABS, φ 6.7mm	A76		Length: 29.2m m, ABS, φ 6.7mm
A73		Length: 31.92mm, ABS, φ4.2mm	A75		Length: 30.82m m, ABS, φ5mm	A77		Length: 25.7m m, ABS



## 4 Holter NIBP Cuffs

### Product Features

1. Ergonomic design, fits with the arm well;
2. Easy to clean, soft and comfortable material, breathable;
3. Reusable, cost-effective.

OEM Manufacturer & Models	Product Picture	Patient Size	Limb Circumference	Order Code	Descriptions	Price
All types of holter blood pressure recorder		Small Adult	17-26cm	Y001S1-A06	Durable, TPU material, with female bayonet connector	
		Adult	24-32cm	Y001A1-A06	Durable, TPU material, with female bayonet connector	
		Adult	24-32cm	Y001A1	Durable, TPU material	
		Large Adult	32-42cm	Y001L1-A06	Durable, TPU material, with female bayonet connector	
		Adult	24-32cm	Y002A1-A06	Durable, TPU material, with female bayonet connector	
		Adult	24-32cm	Y002A1	Durable, TPU material	

Declaration: Shenzhen Med-Link Electronics Tech Co., Ltd. ("MedLinket") hereby declares that all registered trademarks, product names, model numbers, etc., mentioned in the document belong to respective original owners or manufacturers. The information referenced herein is intended to clearly describe the compatibility features of MedLinket products for reference only and should not be construed as an operational guideline for medical institutions or related entities. If any adverse consequences arise from misunderstanding or incorrect use of the information, MedLinket shall not be held liable.



## 5 NIBP Cuffs Interconnect Tubing(Air Hose)



YA25A06-05

















YA29A119-08





















YA40A109-12



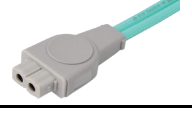









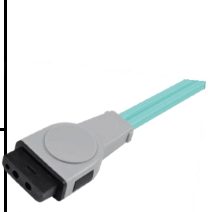





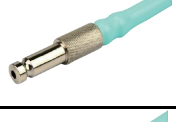

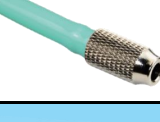











YA106A06-10





OEM Manufacturer	Patient Size	Plug to Monitor	Plug to Cuff	OEM #	Order Code	Descriptions	price
<b>Compatible Colin (Also See Nihon Kohden)</b>							
Colin, Criticare, CSI Datascope, NihonKohden, Datascope	Adult Pediatric			MP00953	YA07A08-10	10ft (3.0m), single tube suitable for use with A07 connector	B3
<b>Compatible Creative (China)</b>							
Creative	Adult Pediatric				YA18A01-10	10ft (3.0m), single tube fit for all Barbed diameter4mm (5/32in) air connector	B3
<b>Compatible Drager/Siemens</b>							
Infinity Delta, Infinity Gamma, Infinity Kappa, Infinity Vista, SC 6000, SC 7000, SC 8000, SC 9000	Adult Pediatric			MP00953	YA29A06-08	8ft(2.4m),single tube suitable for use with A04, A05,A19,A20 connector	B7
	Adult Pediatric				YA29A06-12	12ft(3.6m),single tube suitable for use with A04, A05,A19,A20 connector	B7
	Infant Neonate			2870298	YA29A30-08	8ft (2.4m),single tube suitable for use with A02,A25,A26 connector	B7
	Adult Pediatric			MP00953	YA29A117-08	8ft (2.4m),Single tube suitable for use with A118 connector	B0
	Adult Pediatric				YA29A119-08	10.5ft (3.2m),Single tube suitable for use with A118 connector	A1
<b>Compatible Fukuda NIBP Hose</b>							
Fukuda Denshi vDS-8000	Adult Pediatric				YA47A48-06	6ft (1.8m), single tube suitable for use with A63 connector	C0
	Adult Pediatric				YA47A48-10	10ft (3m), single tube suitable for use with A63 connector	C0
	Adult Pediatric				YA47A06-10	10ft(3m),single tube suitable for use with A04,A05,A19,A20 connector	B3
	Infant Neonate				YA48A48-12	12ft (3.6m), single tube suitable for use with A63 connector	B3
<b>Compatible Goldway (China) (See Quick-Release NIBP Hose)</b>							
Goldway 3F Medical System	Adult Pediatric				YA10A01-12	12ft (3.6m), single tube fit for ID2.5mm-4.0mm tube	B3

OEM Manufacturer	Patient Size	Plug to Monitor	Plug to Cuff	OEM #	Order Code	Descriptions	price	
<b>Compatible GE</b>								
GE-Dinamap Pro series, Compact, MPS ProCare series	Adult Pediatric				YA24A34-12	12ft(3.6m),dual tube suitable for use with A33 connector	C2	
	Adult Pediatric				YA24A34-24	24ft (7.3m),dual tube suitable for use with A33 connector	C8	
	Adult Pediatric			107365	YA24A33-12	12ft(3.6m),dual tube suitable for use with A34 connector	C8	
	Adult Pediatric			107366	YA24A33-24	24ft (7.3m),dual tube suitable for use with A34 connector	C9	
	Adult Pediatric				YA24A10-12	12ft (3.6m),dual tube suitable for use with A09 connector	B8	
	Adult Pediatric				YA24A10-24	24ft (7.3m),dual tube suitable for use with A09 connector	B8	
	Adult Pediatric				YA24A109-12 (2018)	12ft (3.6m),dual tube suitable for use with A108 connector	C2	
	Infant Neonate				107368	YA24A16-12	12ft (3.6m),dual tube suitable for use with A02,A25,A26 connector	B8
	Adult Pediatric				107363	YA24A12-12	12ft (3.6m),dual tube suitable for use with A11 connector	B8
GE-Datex Ohmeda AS/3, CS/3, Cardiocap II, Cardiocap/5, Light, S/5	Adult Pediatric			9461-203	YA22A12-12	12ft (3.6m),dual tube suitable for use with A11 connector	B8	
	Adult Pediatric				YA22A12-10	10ft (3m),dual tube suitable for use with A11 connector	B8	
	Adult Pediatric			9461-214	YA22A34-12	12ft (3.6m),dual tube suitable for use with A33 connector	B8	
	Infant Neonate				9461-205	YA22A16-08	8ft (2.4m),dual tube suitable for use with use with A02,A25,A26 connector	B8



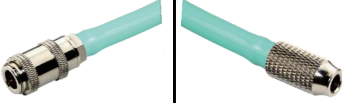

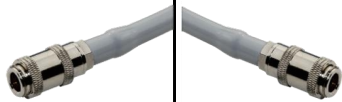
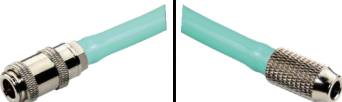
OEM Manufacturer	Patient Size	Plug to Monitor	Plug to Cuff	OEM #	Order Code	Descriptions	price	
GE marquette	Adult Pediatric				YA23A10-12	12ft (3.6m),dual tube suitable for use with A09 connector	C7	
	Infant Neonate				YA23A16-08	8ft (2.4m),dual tube suitable for use with use with A02,A25,A26 connector	B8	
Marquette: Eagle 4000, SOLAR, Tram 100/200/300	Adult Pediatric			9461-217	YA40A10-12	12ft (3.6m),dual tube suitable for use with A09 connector	C7	
	Adult Pediatric			414873-001	YA40A12-12	12ft (3.6m),dual tube suitable for use with A11 connecto	B8	
Marquette: Eagle 4000, SOLAR, Tram 100/200/300	Adult Pediatric				YA40A34-12	12ft (3.6m),dual tube suitable for use with A33 connector	C7	
	Adult Pediatric				YA40A11-12	12ft (3.6m),dual tube suitable for use with A12 connector	B8	
	Adult Pediatric				YA40A11A12-12	12ft (3.6m),dual tube suitable for use with A11,A12 connector	B8	
	Adult Pediatric			2058203-002	YA40A109-12	12ft (3.6m),dual tube suitable for use with A108 connector	B8	
	Infant Neonate					YA40A16-08	8ft (2.4m),dual tube suitable for use with A02,A25,A26 connector	B8
	Infant Neonate					YA51A16-12	12ft (3.6m),dual tube suitable for use with A02,A25,A26 connector	C0
	Infant Neonate				2017009-001 414874001	YA53A16-08	8ft (2.4m),dual tube suitable for use with A02,A25,A26 connector	C0
					YA53A16-12	12ft (3.6m), dual tubesuitable for use withA02,A25, A26 connector	C0	
GE medical Critikon, Kontron, Invivo	Adult Pediatric			88845	YA34A34-24	24ft (7.3m),dual tube suitable for use with A33 connector	B8	
	Adult Pediatric				YA34A109-08	8ft (2.4m),dual tube suitable for use with A108 connector	C0	

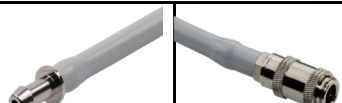
OEM Manufacturer	Patient Size	Plug to Monitor	Plug to Cuff	OEM #	Order Code	Descriptions	price
GE medical Critikon, Kontron, Invivo	Adult Pediatric			88845	YA10A12-08	8ft (2.4m), dual tube suitable for use with A11 connector	C7
GE Healthcare CARESCAPE ONE Mini	Adult Pediatric			2087389-002	YA51A109-12	12ft(3.6m), dual tube suitable for use with A108 connector	C0
Marquette	Infant Neonate			2058204-002	YA53A59-08	8ft (2.4m), dual tube suitable for use with A65 connector	C0
	Infant Neonate				YA53A60-08	8ft (2.4m), single tube suitable for use with A65 connector	C0
<b>Compatible Mindray (China) (See Quick-Release NIBP Hose)</b>							
BeneView, T1/T5//T6/T8, BeneVision, iMEC5, iMEC6	Adult Pediatric			6200-30-09688	YA106A06-10	12ft (3.6m), single tube suitable for use with A04, A05, A19, A20 connector	B0
					YA106A06-08	8ft (2.5m), single tube suitable for use with A04, A05, A19, A20 connector	B0
NIBP Cuff Tubing Adapter, suitable for use with A04	Infant Neonate				YA04A30-01	NIBP Cuff Tubing Adapter 1ft (0.3m), single tube suitable for use with A02, A25, A26 connector	B0
Philips A1/A3	Adult Pediatric				YA06A04-10	1ft (0.3m), single tube suitable for use with A06 connector	B0
VS-800, iPM989, MEC, PM series	Infant Neonate			6200-30-11560	YA06A30-10	12ft (3.6m), single tube suitable for use with A02, A25, A26 connector	B0
Mindray BeneVision, BeneView, iPM, iMEC, uMEC Series monitor	Neonate			6200-30-11560	YA106A03-10	12ft (3.6m), single tube suitable for use with A02, A25, A26 connector	B0
Mindray BeneVision, BeneView, iPM, iMEC, uMEC Series monitor	Infant Neonate				YA106A30-10	10ft (3.0m), single tube suitable for use with A02, A25, A26 connector	B0
<b>Compatible Comen</b>							

OEM Manufacturer	Patient Size	Plug to Monitor	Plug to Cuff	OEM #	Order Code	Descriptions	price
<b>Compatible Nihon Kohden</b>							
BSM/PVB series	Adult Pediatric			YN-900P	YA28A11-08	8ft (2.4m),single tube suitable for use with A12 connector	C2
	Adult Pediatric				YA28A11-12	12ft (3.6m),single tube suitable for use with A12 connector	C1
	Infant Neonate			YN-920P	YA28A30-08	8ft (2.4m),single tube suitable for use with A02,A25,A26 connector	C2
Nihon Kohden SVM-7501; SVM-7503; SVM-7521, SVM-7523, SVM-7601, SVM-7603, SVM-7621, SVM-7623	Adult Pediatric			YN-701S	YA54A11-10	10ft (3m),single tube suitable for use with A12 connector	C1
<b>Compatible Medtronic Physio Control</b>							
LIFEPAK 15	Adult Pediatric				YA100A03-10	10ft (3m),single tube suitable for use with A02,A25,A26 connector	B6
					YA100A03-10H	10ft (3m),coiled single tube suitable for use with A02,A25,A26 connector	B6
					YA100A06-10H	10ft (3m),coiled single tube suitable for use with A04,A05,A19,A20 connector	C2
<b>Compatible OMNIMED</b>							
	Adult Pediatric				YA14A06-10	10ft (3m), single tube suitable for use with A04, A05, A19,A20 connector	B6
<b>Compatible Philips (Also See Quick-Release NIBP Hose and Mindray)</b>							
Philips All models except A1/A3	Adult Pediatric			M1598B	YA25A06-05	5 ft(1.5m),single tube suitable for use with A04,A05,A19,A20 connector	B3
	Adult Pediatric			M1599B	YA25A06-10	10ft(3m),single tube suitable for use with A04,A05,A19,A20 connector	B3
	Adult Pediatric				YA25A03-10	10ft (3m), coiled single tube suitable for use with A02, A25, A26 connector	B3
	Adult Pediatric			M1599B	YA25A06-10H	10ft (3m),coiled single tube suitable for use with A04,A05,A19,A20 connector	C2
	Adult Pediatric				YA25A30-10	10ft (3m),single tube suitable for use with A02,A25,A26 connector	B4

OEM Manufacturer	Patient Size	Plug to Monitor	Plug to Cuff	OEM #	Order Code	Descriptions	price
Philips A1/A3	Adult Pediatric	See Quick-Release NIBP Hose			YA06A06-10	10ft(3m),single tube suitable for use with A04, A05,A19,A20 connector	B4
Philips	Adult Pediatric				YA06A01-10	10ft (3m), single tube fit for ID2.5mm-4.0mm tube	B4
	Adult Pediatric				YA06A01-12	12ft (3.6m),single tube fit for ID2.5mm-4.0mm tube	B4
	Infant Neonate				YA06A30-08	8ft (2.4m),single tube suitable for use with A02, A25,A26 connector	B4
	Adult Pediatric			M1599B	YA04A06-10H-U	10ft(3m),single tube suitable for use with A04, A05,A19,A20 connector	C2
IntelliVue MMX, MX100, X3 (NEW compliant ISO 80369-1)	Neonate						
	Adult Pediatric			9898032 09771	YA80A06-10	10ft(3m),single tube suitable for use with A04, A05,A19,A20 connector	B4
<b>Compatible Unicare Medical Centre</b>							
Unicare	Adult Pediatric				YA06A06-06	6ft (2.0m), single tube suitable for use with A04, A05, A19, A20 connector	B4
	Infant Neonate				YA06A30-08	8ft (2.4m),single tube suitable for use with A02, A25,A26 connector	B4
	Adult Pediatric				YA122A00-08	8ft (2.4m),single tube	B2
	Adult Pediatric				YA55A06-06	6ft (2.0m), single tube suitable for use with A04, A05, A19, A20 connector	B6













OEM Manufacturer	Patient Size	Plug to Monitor	Plug to Cuff	OEM #	Order Code	Descriptions	price
<b>Compatible Welch Allyn</b>							
Connex Spot, Spot Vital Signs IXi	Adult Pediatric			4500-30	YA52A12-10	10ft(3.0m),dual tube suitable for use with A11 connector	B9
	Adult Pediatric				YA52A12-06	6ft(2m),dual tube suitable for use with A11 connector	B9
	Adult Pediatric			4500-31	YA52A10-10	10ft (3.0m),dual tube suitable for use with A09 connector	B9
	Adult Pediatric				YA52A109-10	10ft (3.0m),dual tube suitable for use with A108 connector	B9
Connex Spot, Spot Vital Signs IXi	Infant Neonatec				YA52A16-10	10ft (3.0m),dual tube suitable for use with A02,A25,A26 connector	B9
Spot Vital Signs	Adult Pediatric				YA00A06-10	10ft (3m), single tube suitable for use with A04, A05, A19, A20 connector	B2
<b>Compatible Shanghai nuocheng</b>							
Shanghai nuocheng	Adult Pediatric				YA18A06-10	10ft (3m), single tube suitable for use with A04, A05, A19, A20 connector	B4
<b>Compatible ZOLL (See Quick-Release NIBP Hose)</b>							
Zoll X series monitors	Adult Pediatric			8300-0002-01	YA116A12-12	12ft (3.6m), dual tube suitable for use with A11 connector	E0
E Series, M Series	Adult Pediatric			8000-0655	YA06A12-08	8ft (2.4m), single tube suitable for use with A11 connector	B8
					YA06A12-10	10ft(3m), single tubesuitable for use with A11 connector	B8
<b>Compatible Shanghai nuocheng</b>							
Bionet: BMP300 CSI: 506 series Datex Ohmeda enGuard CM5 Edan: M3, M3A, M3B, M8 Datascop: Accutorr Plus, Accutorr V, DPM3 Spacelabs: 90369	Adult Pediatric			Philips: M3918A Spacelabs: 714-0018-00	YA06A06-10	10ft(3m),single tube suitable for use with A04, A05,A19,A20 connector	B4
	Adult Pediatric				YA06A06-10H	10ft (3m),coiled single tube suitable for use with A04, A05,A19,A20 connector	B0
	Adult Pediatric				YA06A06-12	12ft (3.6m),single tube suitable for use with A04, A05,A19,A20 connector	B3
	Infant Neonate				YA06A30-10	10ft(3m),single tube suitable for use with A02, A25,A26 connector	B3

OEM Manufacturer	Patient Size	Plug to Monitor	Plug to Cuff	OEM #	Order Code	Descriptions	price
<b>Compatible INFUNIX TECHNOLOGY</b>							
INFUNIX TECHNOLOGY	Adult Pediatric				YA05A05-07	7ft(2m),single tube suitable for use with A06 connector	B3
<b>Compatible HPMS109 (铂云)</b>							
HPMS109	Adult Pediatric				YA85A06-08	8ft(2.4m),single tube suitable for use with A04, A05,A19,A20 connector	B3



## 1.1 Air Hose Connectors(Cuff Side)

OEM Manufacturer & Models	Product Picture	OEM #	Order Code	Descriptions	Matched with	Package	price
<b>Air Hose Connectors (Suitable for Infants/Neonates)</b>							
GE-DINAMAP		300667	A02	5/32 in.ID barbed to male slip luer metal,fit for ID 4.0mm tube	Female slip luer (A03,A15, A16)	10pcs/pk	A8
GE Marquette			A16	5/32 in.ID barbed to female slip luer, plastic,fit for ID 2.5mm-4.0mm tube	Female slip luer (A02,A25, A26)	10pcs/pk	B6
Datex			A25	5/32 in.ID barbed to male slip luer, plastic,fit for ID4.0mm tube and OD4.0mm tube	Female slip luer (A03,A15, A16)	10pcs/pk	A3
Welch Allyn		5082-176	A26	Barbed to male luer slip type plastic,fit for ID 2.5mm tube	Female slip luer (A03,A15, A16)	10pcs/pk	A3
Pacific Medical		PM20	A30	5/32 in.ID barbed to female slip luer metal,fit for ID 4.0mm tube	Male slip luer, (A02,A25,A26)	10pcs/pk	A2
<b>Air Hose Connectors(Suitable for Adult/Pediatric)</b>							
Air Hose Connector		GE P/N: 300670	A01	Barbed to barbed plastic,fit for ID 2.5mm-4.0mm tube.	All barbed diameter 5/32in air connector	10pcs/pk	A3
L&T, Critikon, Datex		GE P/N: 300669 Welch Allyn P/N; 5082-169	A03	5/32 in.ID barbed to female slip luer, metal,fit for ID 4.0mm tube	Male slip luer, (A02,A25,A26)	10pcs/pk	A8
GE,Marquette and Protocol		GE P/N: 330064 Welch Allyn P/N; 5082-182	A11	(Quick disconnect locking type)female submin to 5/32 in.ID barbed,plastic,fit for ID 2.5mm-4.0mm tube	Male submin fit for A12 connector	10pcs/pk	B6
Fukuda			A63		Fit for A48 connector	10pcs/pk	B6













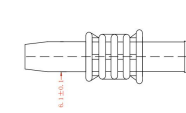

OEM Manufacturer & Models	Product Picture	OEM #	Order Code	Descriptions	Matched with	Package	price
Philips Siemens Datascope and Colin		GE P/N: 330059 Welch Allyn P/N:5082-184	A04	Male bayonet to 5/32 in.ID barbed metal,fit for D4.0mm tube	Female bayonet, fit for A06	10pcs/pk	A8
		Welch Allyn P/N:5082-184	A05	Male bayonet to 5/32 in.ID barbed plastic,fit for ID 2.5mm-4.0mm tube	Female bayonet, fit for A06	10pcs/pk	A5
		GE P/N: 330060	A06	5/32 in.ID barbed to female bayonet metal,fit for ID 3.0mm-4.0mm tube	Male bayonet, fit for A04,A05, A19,A20	10pcs/pk	A4
Spacelabs Datascope and Colin		GE P/N: 300668 Welch Allyn P/N:5082-168	A07	(Plastic luer lock) female locking luer to 5/32 in.ID barbed plastic,fit for ID 3.0mm-4.0mm tube	Male locking luer,fit for A07	10pcs/pk	A5
		GE P/N: 300665 Welch Allyn P/N:5082-165	A08	5/32 in.ID barbed to male locking luer (plastic luer lock), plastic,fit for ID 2.5mm-4.0mm tube	Female locking luer,fit for A08	10pcs/pk	A5
Spacelabs Colin Datascope		GE P/N: 300668 Welch Allyn P/N:5082-168	A36	Female metal luer lock conneter metal fit for ID 3.0mm-4.0mm tube	Fit for A37	10pcs/pk	A6
		GE P/N: 300665 Welch Allyn P/N:5082-165	A37	Male metal luer lock connector, metal,fit for ID 2.5mm-4.0mm tube	Fit for A36	10pcs/pk	A6
GE DINAMAP		GE P/N: 300664 Welch Allyn P/N:5082-164	A09	Male screw to 5/32 in.ID barbed, plastic,fit for ID 2.5mm-4.0mm tube	Female screw, fit for A10	10pcs/pk	A5
		GE P/N: 300619 Welch Allyn P/N:5082-161	A10	5/32 in.ID barbed to female screw, plastic,fit for ID 2.5mm-4.0mm tube	Male screw fit for A09	10pcs/pk	A5
GE DINAMAP		GE P/N: 300664 Welch Allyn P/N:5082-164	A33	Male metal luer lock connector,L=22.6mm, nickel-plated brass, fit for ID 4.00mm tube (5/32in.)	Fit for A34	10pcs/pk	A2
		GE P/N: 300619 Welch Allyn P/N:5082-161	A34	Female metal luer lock connector,L=23.6mm, nicke+plated brass it for ID 4.00mm tube (5/32in)	Fit for A33	10pcs/pk	A2
Nihon Kohden SVM Series			A54	Perfect fit for two-tubes		10pcs/pk	A5
Nihon Kohden BSM/PVM Series			A28	Perfect fit for two-tubes		10pcs/pk	A8

OEM Manufacturer	Product Picture	OEM #	Order Code	Descriptions	Matched with	Package	price
GE Marquette Datex-Ohmeda		GE P/N: 330090	A12	(Quick disconnect locking type) male subminiature to 5/32 in. ID barbed, plastic, fit for ID 2.5mm-4.0mm tube	Female subminiature, fit for A11	10pcs/pk	A8
GE Marquette one-tube systems		GE P/N: 330057 Welch Allyn P/N: 5082-181	A13	5/32 in. ID barbed to female Marquette locking type connector, plastic, fit for ID 2.5mm-4.0mm tube	Male locking connector, fit for A14	10pcs/pk	A7
			A14	5/32 in. ID barbed to male Marquette locking type connector, plastic, fit for ID 2.5mm-4.0mm tube	Female locking connector, fit for A14	10pcs/pk	A2
Welch Allyn		16-41-000	A38	Female metal luer lock connector; L=20mm; nickel-plated brass fit for ID 4.00mm tube (5/32 in.)	Fit for A39	10pcs/pk	A6
		16-40-000	A39	Male metal luer lock connector; L=26.5mm; nickel-plated brass, fit for ID 4.00mm tube (5/32 in.)	Fit for A38	10pcs/pk	A6
			A52	Compatible with Welch Allyn connector, material: nylon	Perfect fit for two-tubes	10pcs/pk	A1
ADAPTER			A15	5/32 in. ID barbed X2 to female slip luer plastic, fit for ID 2.5mm-4.0mm tube	Marquette neonatal, fit for A02, A25, A26	10pcs/pk	A1
			A21	5/32 in. ID barbed X2 to 5/32 in. ID barbed X2, plastic, fit for ID 2.5mm-4.0mm tube	5/32 in. ID tube	10pcs/pk	A5
GE			A108	ID barbed, plastic, white two-tube connector	Two-tubes, fit for A109 A110	10pcs/pk	A5
		212202 296	A109	ID barbed, plastic, black two-tube connector	Perfect fit for two-tubes, fit for A108	10pcs/pk	A5
			A110	ID barbed, plastic, black connector	Perfect fit for single-tube, fit for A108	10pcs/pk	A5
Drager			A117	Compatible with Drager connector, material: nylon	Fit for A118	10pcs/pk	A5
			A118	Compatible with Drager connector, material: nylon	Fit for A117	10pcs/pk	B6
			A119	Compatible with Drager connector, material: nylon	Fit for A118	10pcs/pk	B6







OEM Manufacturer	Product Picture	OEM #	Order Code	Descriptions	Matched with	Package	price
GE marquette			A101	material:Nickel-plated brass (H59-1) surface treatment	Fit for A06	10pcs/pk	
GE-DINAMAP			A115	material:Nickel Plated Brass	Fit for A02	10pcs/pk	
GE marquette			A27	material:HPB59-1 brass,Finish: Nickel plated	Fit for A04	1pcs/pk	
福田			A48	material:Brass with chrome plating	Fit for A50	10pcs/pk	
福田			A50	material:Brass with chrome plating	Fit for A48	10pcs/pk	
UNICARE			A55	material:Nickel-plated brass (H59-1) surface treatment	Fit for HL0024B(4*8 hose)	10pcs/pk	
Ge Ohmeda Nibp Hose			A65	material:POM(JL0046A)	Fit for A60	50pcs/pk	
Mindray			A69	material:Nickel Plated Brass	Fit for A82	10pcs/pk	
GE marquette			A79	Pneumatic tube connector (suitable for inner diameter Φ 2.5MM) material:nylon	Fit for A06	10pcs/pk	
Mindray			A82	迈瑞快速接头	Fit for A26	100pcs/pk	
Readel			A83	material:PC、copper alloy	Fit for A84	10pcs/pk	
			A84	material:PC、copper alloy	Fit for A83	10pcs/pk	

## 1.2 Air Hose Connectors(Instrument Side)







OEM Manufacturer & Models	Product Picture	OEM #	Order Code	Descriptions	Matched with	Package	price
Readel			A17	5/32in.ID barbed to readel air socket,plastic	Readel air plug	10pcs/pk	A3
			A18	5/32 in.ID barbed to readel air plug, plastic,fit for ID 4.0mm tube	Readel air socket	10pcs/pk	A3
Philips			A19	Male bayonet socket to 5/32 in ID barbed,metal, L=29mm,fit for ID4.0mm tube	Female bayonet fit for A06	10pcs/pk	A2
			A20	Male bayonet socket to 5/32 in ID barbed,meta L=38mm,fit for ID4.0mm tube	Female bayonet fit for A06	10pcs/pk	A2
Philips IntelliVue MMX,MX100,X3 (NEW compliantISO 80369-1)			A80	Male bayonet socket $\Phi$ 4.9mm,metal.L=35.9mm, fit for ID 5.1mm tube	fit for ID 5.1mm tube	10pcs/pk	A2
The connector of air hose for Reusable BP Cuffs			A31	Female metal luer lock connector L=22mm,nickel-plated brass,fit for ID4.00mm tube	Fit for A32	10pcs/pk	A2
			A32	Male metal luer lock connector, L=27.3mm, nickel-plated brass fit for ID 4.00mm	Fit for A31	10pcs/pk	A5
GE Eagle 4000, Tram 100/200/250/300/350, Corometrics 118			A22	5/32in.ID barbed*2 to round connector	Perfect fit for two-tubes	10pcs/pk	A5
GE Eagle 3000, Dash 2000/3000/4000, Tram 400/450/451, Tram 800/850/851, Corometrics 120			A40		Perfect fit for two-tubes	10pcs/pk	A5
GE marquette			A53	Rectangular connector	Fit for Neonatal connectors OEM-3756A	1pcs/pk	A5
GE marquette			A23		Perfect fit for two-tubes	1pcs/pk	A5
GE DINAMAP, Pro, Compact, MPS Series			A24	Gray shroud connector	Perfect fit for two-tubes	10pcs/pk	A5

OEM Manufacturer & Models	Product Picture	OEM #	Order Code	Descriptions	Matched with	Package	price
Mindray BeneVision			A106	material:Surface bright nickel plating 3μm		10pcs/pk	
Zoll			A116			10pcs/pk	
UNICARE			A122	material:aluminum (chemistry)		10pcs/pk	
Physio-control LIFEPAK 15			A100	material:Nickel-plated brass (H59-1) surface treatment		10pcs/pk	
HPMS109 (铂云)			A85	material:Gray ABS rubber		10pcs/pk	
Omron			A62	material:ABS, white, high-gloss glossy	Fit for Household NIBP Cuffs	50pcs/pk	
Omron Pacific Medical			A64	material:ABS		50pcs/pk	
Omron			A87	material:Blue ABS rubber		10pcs/pk	
Omron (YA84 OMRON connector set, contains the following connectors)			A72	Length: 31.75mm, material:ABS,φ6mm		10pcs/pk	
			A73	Length: 31.92mm, material:ABS,φ4.2mm		10pcs/pk	
			A74	Length: 30.92mm, material: ABS,φ6.7mm		10pcs/pk	
			A75	Length: 30.82mm, material:ABS,φ5mm		10pcs/pk	
			A76			10pcs/pk	
			A77	Length: 25.7mm, material:ABS		10pcs/pk	

### 1.3 Air Hose

Product Picture	Order Code	Descriptions	Material	Color	Outer Diameter	Inner Diameter	price
	HL0024B	Adult/Pediatric single tube (300mm/pc)	Silicone 70A	Gray	08mm	04mm	
	HL0024D	Adult/Pediatric single tube (200mm/pc)	Silicone 554	White	08mm	04mm	
	HL0024E	Adult/Pediatric single tube (300mm/pc)	Silicone 70A	Black	08mm	04mm	
	HL0024N	Adult/Pediatric single tube	Silicone 70A	Gray	08mm	04mm	
	SL0008A	Neonate/Infant single tube	TPU 95A	Gray	06mm	03mm	
	SL0008B	Neonate/Infant double tube	TPU 95A	Gray	05.55*011.6 mm	03mm	

### 6.4 Y Adapter

Product Picture	OEM #	Order Code	Descriptions	Package	price
	GE:300829 Welch Allyn: 5082-183	SL0424A/(Add A49)	1 Unfitted to 2 Unfitted	20pcs	B8
	Mindray: 040-001543-00	YA03A49-A02A02	1 Female Slip Luer(A03) to 2 Male Slip Luer(A02)	10pcs	G6
	Mindray: 040-001544-00	YA06A49-A09A09	1 Female Bayonet(A06) to 2 Male Screw(A09)	10pcs	F0
	Mindray: 040-001545-00	YA06A49-A11A11	1 Female Bayonet(A06) to 2 Female Submin(A11)	10pcs	H0
	Mindray 040-001546-00	YA06A49-A11A12	1 Female Bayonet(A06) to 1 Female Submin(A11) and 1 Male Submin(A12)	10pcs	H0
		YA06A49-A108	1 Female Bayonet(A06) to 2 Female Submin(A110 or A109)	10pcs	H0
		YA11A49	1 Female Submin(A11) to 2 Unfitted	10pcs	C5



## Disposable Blood Pressure Cuffs Cover

### Product Features

1. The cuff cover will help prevent cross-contamination.
2. Adopted Elastic waterproof non-woven medical material, to prevent liquids from soaking through.
3. It is soft to the skin and will still allow accurate readings.
4. Light, economical and are simply thrown away after use.
5. It offers an added level of protection that is beneficial to both the patient and the blood pressure cuff itself(to keep the cuff from getting contaminated).

### Scope of Application

It is used to prevent cross-infection and protect the cuff when the reusable blood pressure cuff is used in the operating room, ICU, and clinic.

## Steps for Usage



**Step 1:**  
Wear the disposable blood pressure cuff cover on top of patient's arm.

**Step 2:**  
Apply reusable blood pressure cuff directly over this cuff cover.

**Step 3:**  
Follow the cuff cover index line and turn over the upper part of the cuff cover outward to cover the blood pressure cuff.

## Product Specifications

Patient Size	Limb Circumference	Order Code	Descriptions	Package	Matched with	price
Children	Limb cir. =10~28cm	Y000DS	Elastic waterproof non-woven medical material, pediatric size	85pcs/box	Y000C1	
Adult	Limb cir. =17~37cm	Y000DM	Elastic waterproof non-woven medical material, adult size	50pcs/box	Y000A1	
Large adult	Limb cir. =34~54cm	Y000DL	Elastic waterproof non-woven medical material, large adult size	30pcs/box	Y000L1	

Declaration: Shenzhen Med-Link Electronics Tech Co., Ltd. ("MedLinket") hereby declares that all registered trademarks, product names, model numbers, etc., mentioned in the document belong to respective original owners or manufacturers. The information referenced herein is intended to clearly describe the compatibility features of MedLinket products for reference only and should not be construed as an operational guideline for medical institutions or related entities. If any adverse consequences arise from misunderstanding or incorrect use of the information, MedLinket shall not be held liable.

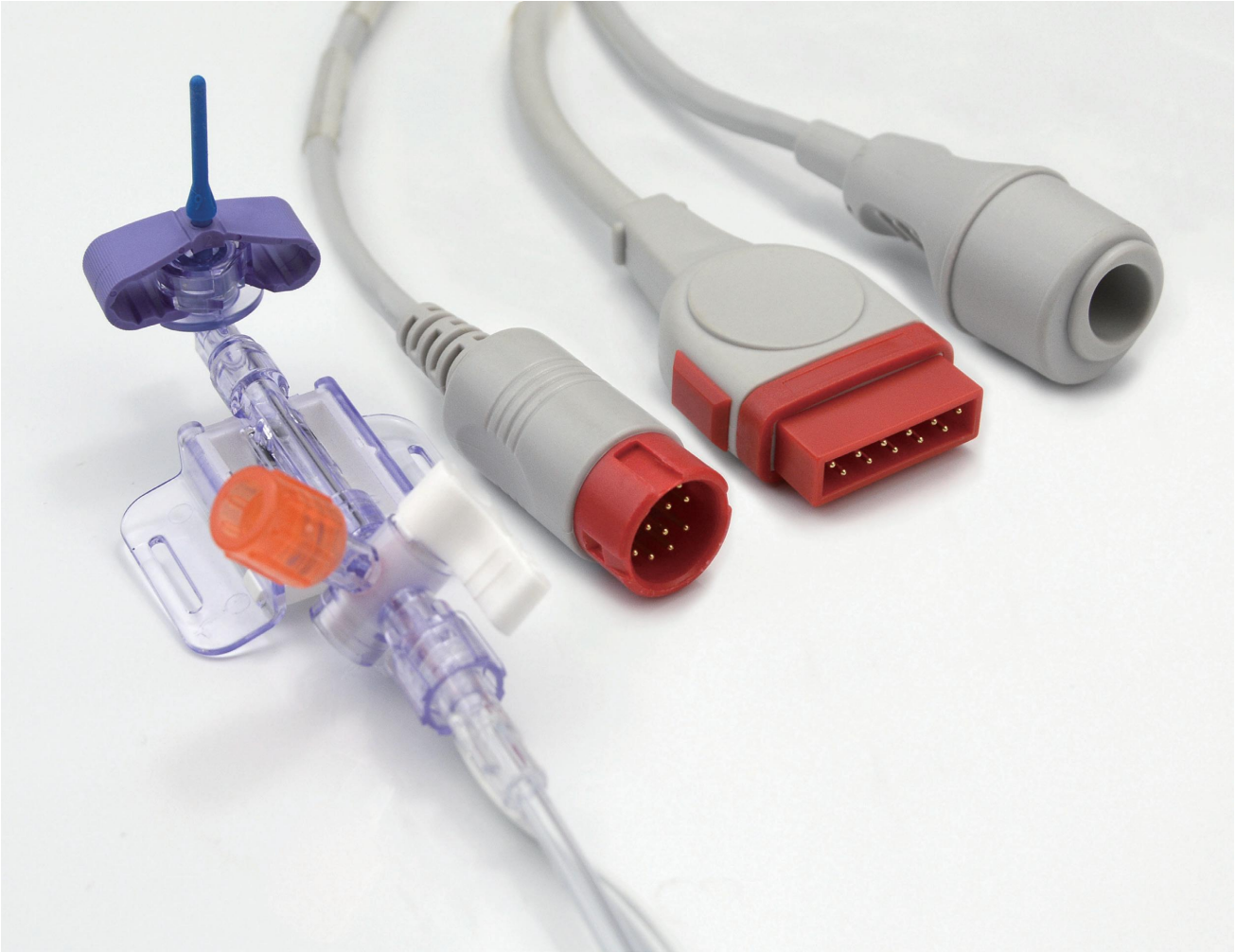

## IBP Adapter Cable & Transducer

### Compliance with

IEC 60601-1  
IEC 60601-2-34  
ISO 10993-1  
ISO 10993-5  
ISO 10993-10

### Compatible Brands

Drager  
Datex-Ohmeda  
GE-Marquette  
Mindray-Datascope  
Nihon Kohden  
Philips  
Spacelabs  
...

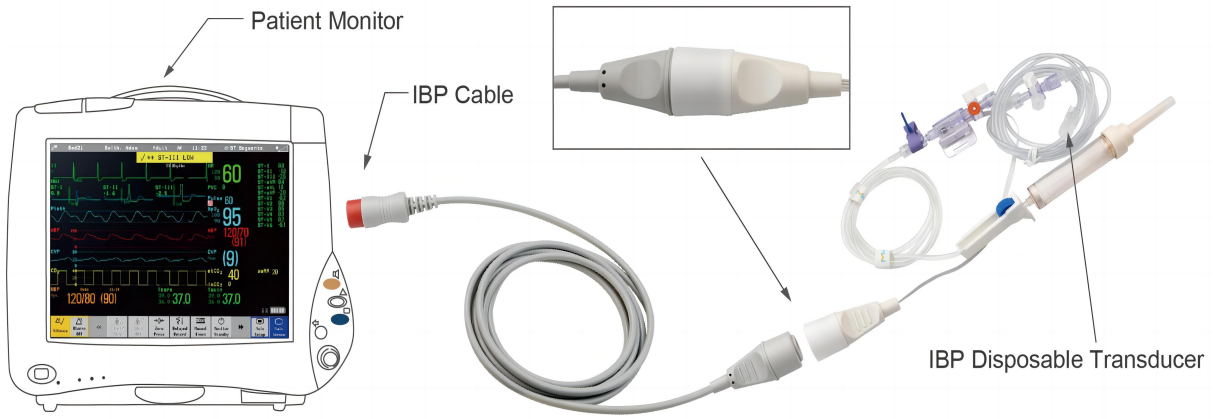

### Instrument Connector

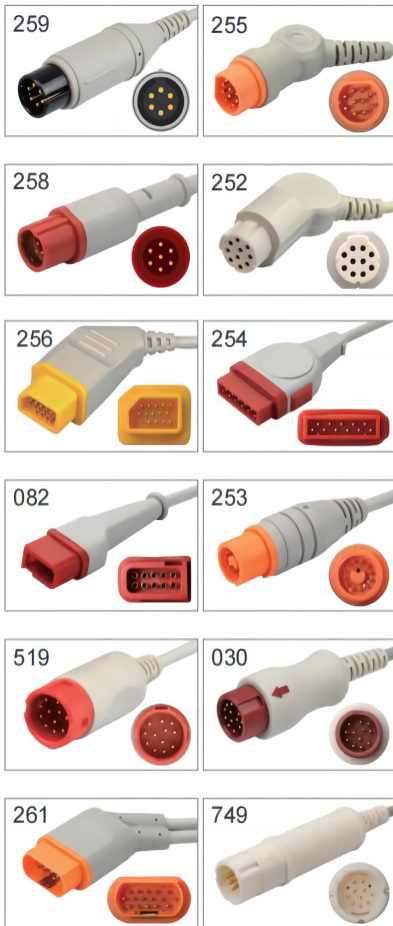

### Transducer Type



### Transducers Connector

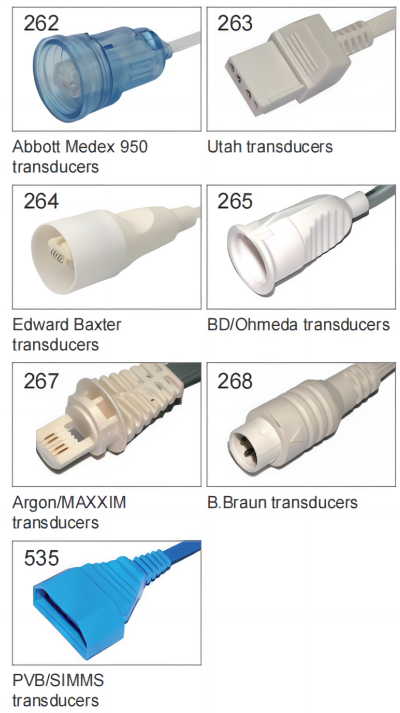

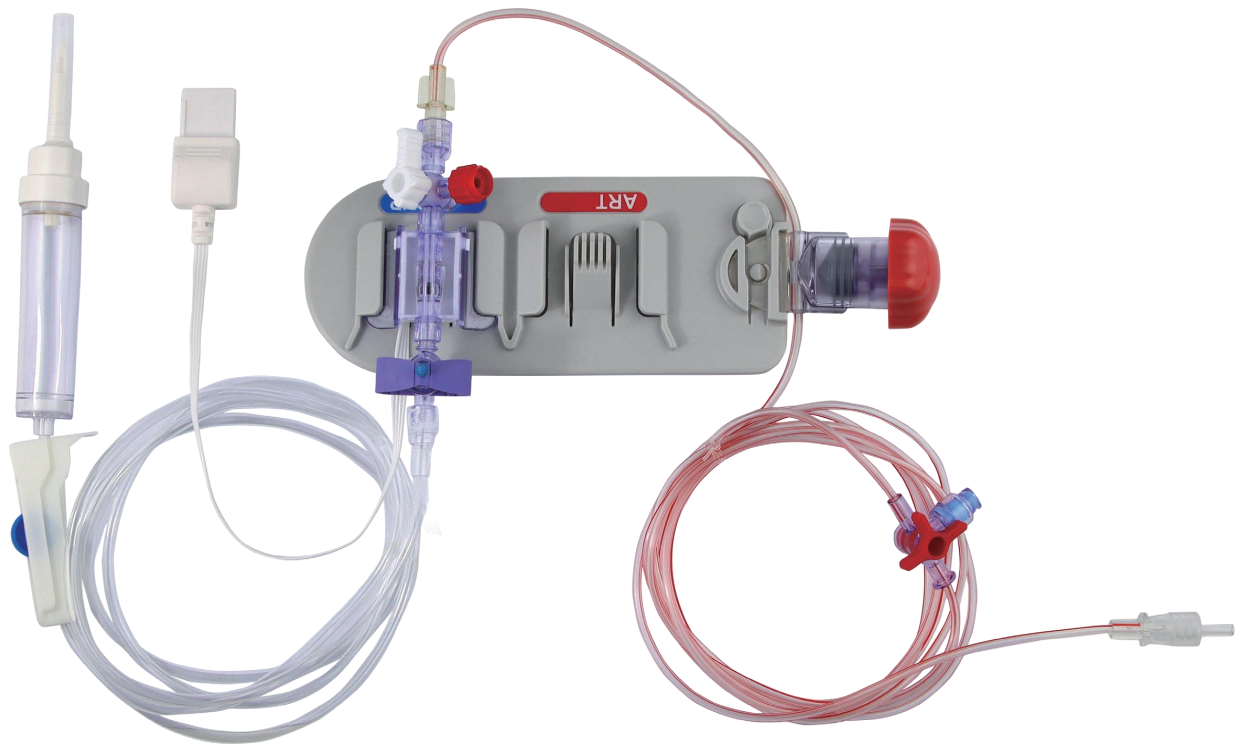

# 1 IBP Disposable Transducer









## Code Rule Description

1. Sterile packaging, disposable;
2. Monitor various blood pressures in the human body such as central venous pressure, arterial pressure, pulmonary arterial pressure, and left atrial pressure;
3. Adopt imported chip, with sensitive reaction and high accuracy;
4. Can provide a variety of specifications of adapters, compatible with most mainstream monitors;
5. Can be matched with various cable connections;
6. Instantaneous hemodynamic changes can be automatically and continuously monitored;
7. Automatic continuous monitoring and sensitive response;
8. Convenient operation, close cooperation and strong stability









## Product Features

Composed of flowmeter, flushing valve, blood pressure sensor, three-way valve, pressure extension tube and IBP cable.









## IBP Disposable Transducer with the Closed Blood Function

Compatible Brand	Productor Picture	Transducer Connector	Order Code	Descriptions	price
Abbott			XA103R222	Connector: RJ11-6P6C Requires IBP adapter cable, 1pcs/bag	
UTAH			XB103R222	Connector: 1.58 Jack x 4pin Requires IBP adapter cable, 1pcs/bag	
Edwards Baxter			XC103R222	Connector: 5pin Requires IBP adapter cable, 1pcs/bag	
BD/Ohmeda			XD103R222	Connector: Round 7pin Requires IBP adapter cable, 1pcs/bag	
Argon/MAXXIM			XE103R222	Connector: 5pin Requires IBP adapter cable, 1pcs/bag	
B.Braun			XF103R222	Connector: 1.0x4pin Requires IBP adapter cable, 1pcs/bag	
PVB/SIMMS			XG103R222	Connector: 1.5 Jack x 5pin Requires IBP adapter cable, 1pcs/bag	

## IBP Disposable Transducer

Compatible Brand	Productor Picture	Transducer Connector	Order Code	Descriptions	price
Abbott			X0046A	Connector: RJ11-6P6C Requires IBP adapter cable, 1pcs/bag	
UTAH			X0046B	Connector: 1.58 Jack x 4pin Requires IBP adapter cable, 1pcs/bag	
Edwards Baxter			X0046C	Connector: 5pin Requires IBP adapter cable, 1pcs/bag	
BD/Ohmeda			X0046D	Connector: Round 7pin Requires IBP adapter cable, 1pcs/bag	
Argon/MAXXIM			X0046E	Connector: 5pin Requires IBP adapter cable, 1pcs/bag	
B.Braun			X0046F	Connector: 1.0x4pin Requires IBP adapter cable, 1pcs/bag	
PVB/SIMMS			X0046G	Connector: 1.5 Jack x 5pin Requires IBP adapter cable, 1pcs/bag	

## IBP Disposable Transducer(Cost-effective)

Compatible Brand	Product Picture	Transducer Connector	Order Code	Descriptions	price
Abbott			XA103T420	Connector: RJ11-6P6C Requires IBP adapter cable, 1pcs/bag	
UTAH			XB103T420	Connector: 1.58 Jack x 4pin Requires IBP adapter cable, 1pcs/bag	
Edwards Baxter			XC103T420	Connector: 5pin Requires IBP adapter cable, 1pcs/bag	
BD/Ohmeda			XD103T420	Connector: Round 7pin Requires IBP adapter cable, 1pcs/bag	
Argon/MAXXIM			XE103T420	Connector: 5pin Requires IBP adapter cable, 1pcs/bag	
B.Braun			XF103T420	Connector: 1.0x4pin Requires IBP adapter cable, 1pcs/bag	
PVB/SIMMS			XG103T420	Connector: 1.5 Jack x 5pin Requires IBP adapter cable, 1pcs/bag	

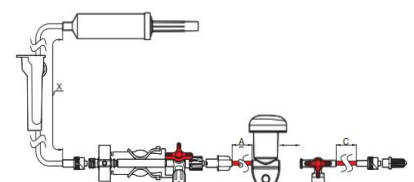
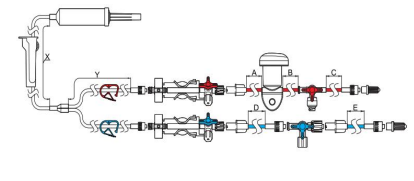
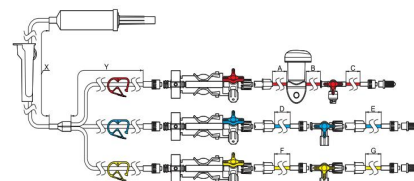
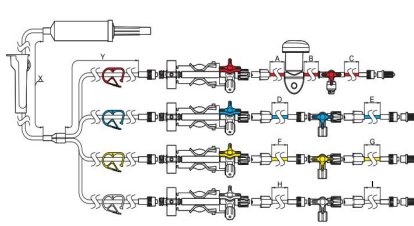

## IBP Disposable Transducer(Multi-channel)

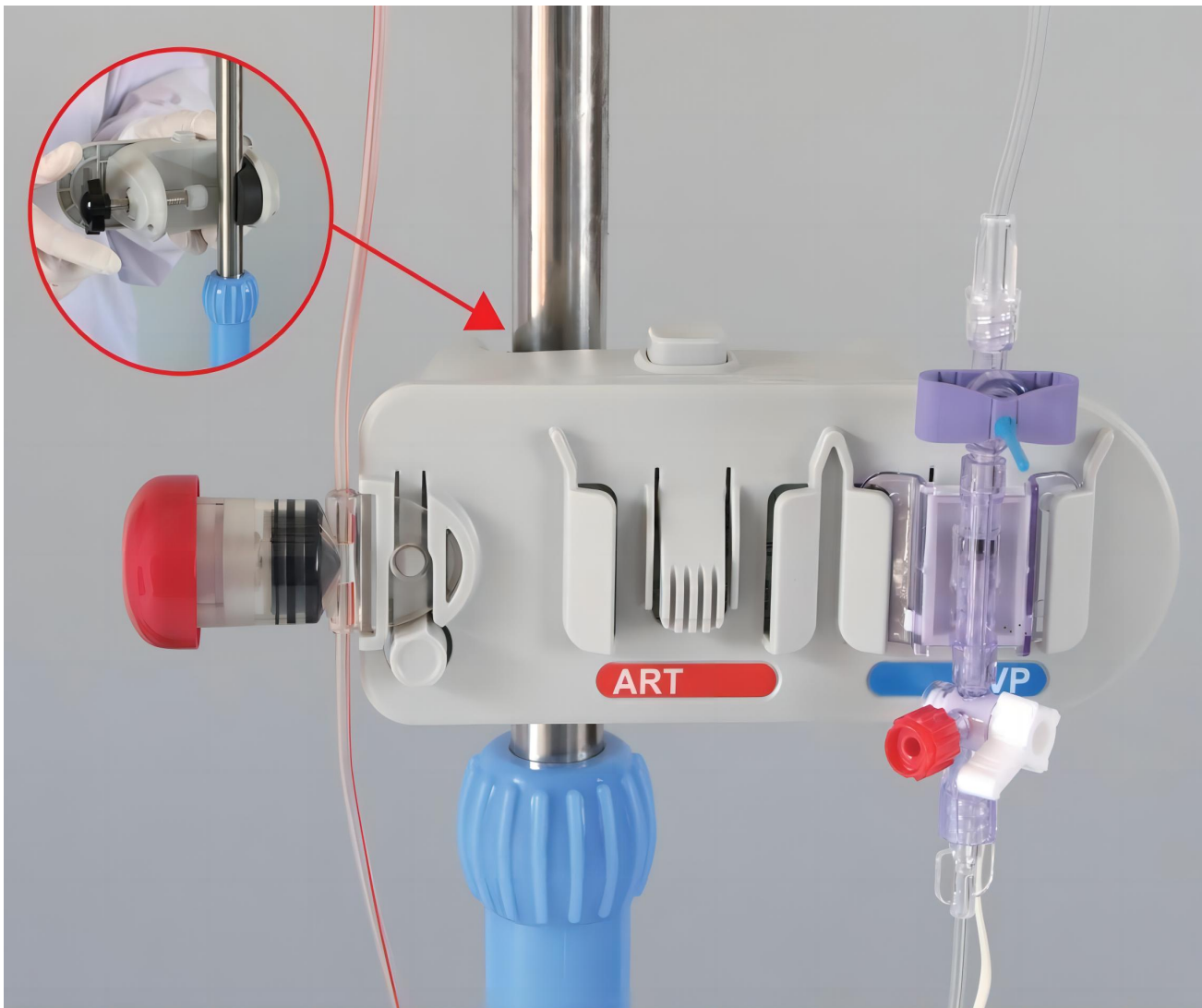
No.	Graph	Order Code	Number of channels/ Infusion Velocity	Pressure Tubing color	Product structure	price
1		XH103R220	Single Channel 3 ml/h ( $\pm 1$ )	Red	Three-way pressure Tubing	
2		XH103B220		Blue		
3		XH103R222		Red	With blood reservoir	
4		XH130T200	Single Channel 30 ml/h ( $\pm 1$ )	Transparency	Straight pressure Tubing	
5		XH130R222		Red	With blood reservoir	
6		XH203M220	Dual-Channel 3 ml/h ( $\pm 1$ )	Mixed	Three-way pressure Tubing	
7		XH203M222		Mixed	With blood reservoir	
8		XH303M220	Three-channel 3ml/h ( $\pm 1$ )	Mixed	Three-way pressure Tubing	
9		XH303M222		Mixed	With blood reservoir	
10		XH403M222	Four-channel 3ml/h ( $\pm 1$ )	Mixed	With blood reservoir	



## 2 IBP Mount Plate and Holders

### Product Specifications

No.	Product Picture	Order Code	Product Name	Descriptions	price
1		X0116A	Equipment mounting bracket	It is used to fix the monitor, oximeter, sensor bracket, etc. on the infusion frame and bed frame. 135*65.6*80.5mm	A0
2		X0118A	IBP Sensor bracket	For fixing disposable IBP transducers, blood reservoirs. 150*60*18mm	A5

### Panel for Multi-Channel Single-Use Invasive Pressure Transducers

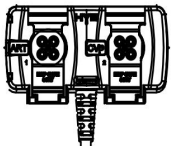
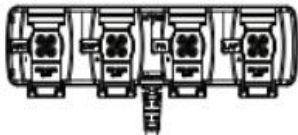
No.	Graph	Descriptions	Order Code	price
1		CONTACT BOARD/MINI BOARD For dual-channel IBP transducer, compatible with all brands	待编码	
2		CONTACT BOARD/MINI BOARD For three-channel and four-channel IBP transducer, compatible with all brands	待编码	





## 3 Pressure Infusion Bags

### Product Features

1. Reuse by single patient to reduce cross-infection (disposable);
2. Medical PU composite material, comfortable to use and easier to clean (disposable);
3. Waterproof nylon cloth, not easy to tear; silicone inflatable tube, comfortable and easy to use (reusable);
4. Pressure indicator, precise control of pressure and flow;
5. Balloons with soft texture, good flexible, palm-sized, and efficient inflation;
6. Over-pressure protection device to avoid excessive inflation pressure and burst, frightening the patient;
7. Equipped with Robert clamp, more reliable in pressure holding;
8. The unique hook design, avoiding the risk of falling off after the blood bag or liquid bag volume



### Scope of Application

It is suitable for emergency blood transfusion and fluid infusion in various clinical departments such as emergency dept., operating room, ICU, emergency center, etc.

Order Code	Picture	OEM #	Capacity	Descriptions	Package	price
<b>Disposable Pressure Infusion Bags</b>						
Y000D05		MX4805	500ml	Pressure indicator, White waterproof nylon cloth, L*W: 309*150mm, With overvoltage protection function	24pcs/ carton	
Y000D10		MX4810	1000ml	Pressure indicator, White waterproof nylon cloth, L*W: 380*150mm, With overvoltage protection function	24pcs/ carton	
Y000D30		MX4830	3000ml	Pressure indicator, White waterproof nylon cloth, L*W: 380*220mm, With overvoltage protection function	24pcs/ carton	

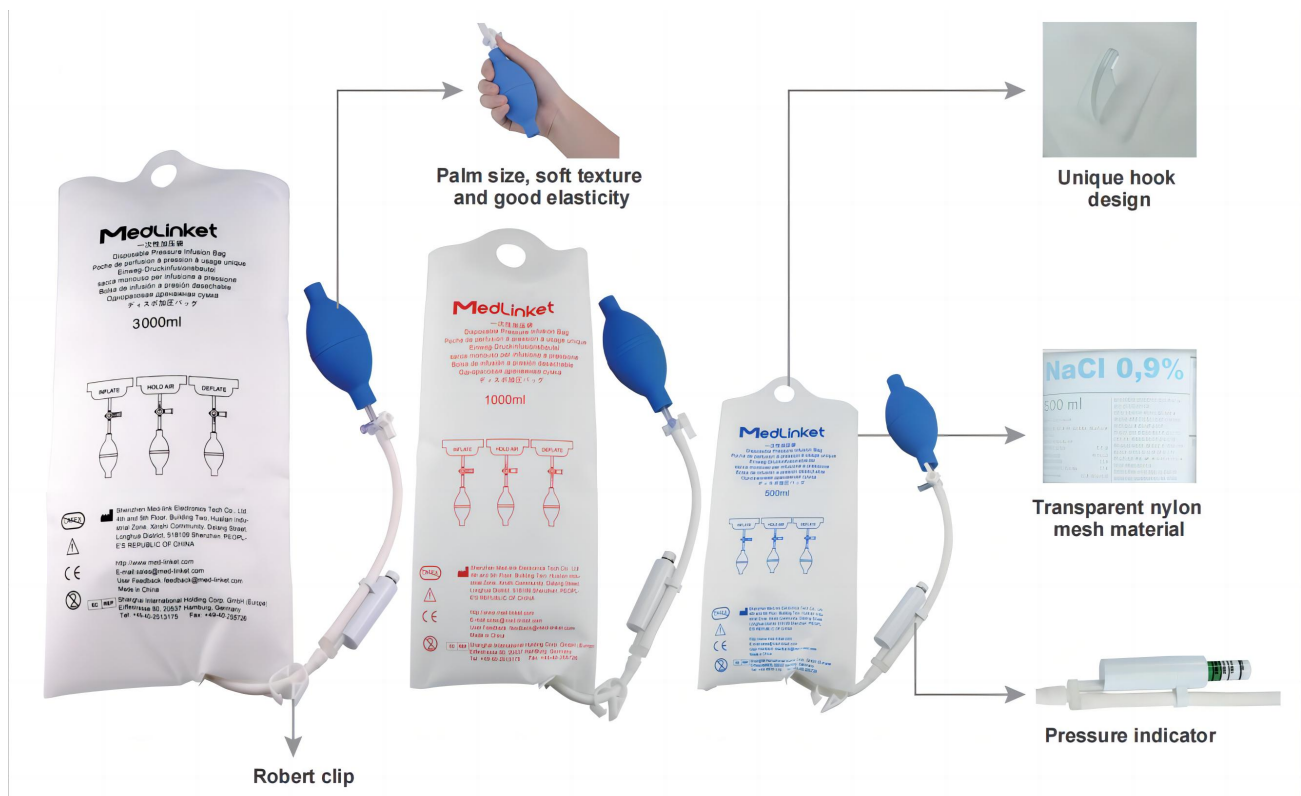
### Product Features



Order Code	Picture	Capacity	Descriptions	Package	pice
<b>Reusable Rressure Infusion Bags</b>					
Y000R05		500ml	Pressure indicator, White waterproof nylon cloth, L*W: 309*150mm, With overvoltage protection function	24pcs/ carton	A0
Y000R10		1000ml	Pressure indicator, White waterproof nylon cloth, L*W: 380*150mm, With overvoltage protection function	24pcs/ carton	B1
Y000R30		3000ml	Pressure indicator, White waterproof nylon cloth, L*W: 380*220mm, With overvoltage protection function	24pcs/ carton	B9



## 4 IBP Cable

### Code Rule Description

S

Yoke type:

- A: Abbott 6pin
- B: Utah 4pin
- C: Edward/Baxter 5pin
- D: BD/Ohmeda 7pin
- E: Argon/MAXXIM 5pin
- F: B.Braun 4pin
- G: PVB/SIMMS 5pin
- J: Medex 950
- K: Ant high-tech

0000: Compatible Brand Code,  
as 0014 indicated Marquette,  
0015 indicated Spacelabs















X: IBP Adapter Cable &  
Transducer













### Product Features















1. Compatible with major monitor IBP module interface and disposable pressure transducer brands in the market;
2. Flexible and durable cables, enduring repeated cleaning and disinfection;
3. Latex free.

OEM Manufacturer & Models	Instrument Connector	Transducers Side (Yoke)	OEM #	Order Code	Descriptions	Price
<b>Compatible 6-Pin IBP Adapter Cables</b>						
<p>AAMI: all            BCI: 9100 Series,            9200 Advisor Series            Edan: iM8, iM80            Invivo: 3500, 3550,            4500 Plus            Datascope:            Passport            Burdick: 3100            Philips: 5microvolt,            78205, 8805            Spacelabs: 300,            400, 500, 600            Welch Allyn            106EL, Encore,            PIC, Propaq 102            Zoll: Propaq MD,            X Series</p>			Mindray: 001C-30-70760	X0015A	For Abbott Transducer, 3.6m	B3
			Mindray: 115-017848-00	X0015B	For Utah Transducer, 3.6m	B3
			Mindray: 0010-21-43094	X0015C	For Edward Transducer, 3.6m	B3
			690-0021-00 Mindray: 001C-30-70758	X0015D	For BD Transducer, 3.6m	B3
				X0015E	For Argon/MAXXIM Transducer, 3.6m	B3
				X0015F	For Original B.Braun Transducer, 3.6m	B3
				X0015G	For PVB Transducer, 3.6m	B3
				X0015J	For Medex Transducer, 3.6m	B3
				X0015K	For Antmed & ACE Medical, PT-01 Transducer, 3.6m	B3

OEM Manufacturer & Models	Instrument Connector	Transducers Side (Yoke)	OEM #	Order Code	Descriptions	price
<b>Compatible Biolight (China) IBP Adapter Cables</b>						
V6 Vital Sign View A2/A3/A5/A6 Q5/Q7				X0113A	For Abbott Transducer, 3.6m	B3
				X0113B	For Utah Transducer, 3.6m	B3
				X0113C	For Edward Transducer, 3.6m	B3
				X0113D	For BD Transducer, 3.6m	B3
				X0113L	For Argon/MAXXIM Transducer, 3.6m	B3
				X0112A	For Abbott Transducer, 3.6m	B3
				X0112B	For Utah Transducer, 3.6m	B3
				X0112C	For Edward Transducer, 3.6m	B3
				X0112D	For BD Transducer, 3.6m	B3
		<b>Compatible Drager/Siemens IBP Adapter Cables</b>				
Drager: Infinity Delta, Infinity Delta XL... Siemens: 1241, 1280, 4041, 630, 700, 960, Axiom Sensis XP, Sirecust 1260, Sirecust 1281, Sirecust 400 Series				X0001A	For Abbott Transducer, 3.6m	B4
			650-203	X0001B	For Utah Transducer, 3.6m	B4













OEM Manufacturer & Models	Instrument Connector	Transducers Side (Yoke)	OEM #	Order Code	Descriptions	Price
<b>Compatible Drager/Siemens IBP Adapter Cables</b>						
Drager: Infinity Delta, Infinity Delta XL... Siemens: 1241, 1280, 4041, 630, 700, 960, Axiom Sensis XP, Sirecust 1260, Sirecust 1281, Sirecust 400 Series				X0001C	For Edward Transducer, 3.6m	B4
			684082	X0001D	For BD Transducer, 3.6m	B4
				X0001E	For Argon/MAXXIM Transducer, 3.6m	B4
				X0001F	For Original B.Braun Transducer, 3.6m	B4
Drager: Infinity Delta, Infinity Delta XL, Infinity Gamma XL ... Siemens: 1241, 1280, 4041, 630, 700, 960, Axiom Sensis XP...				X0032A	For Abbott Transducer, 3.6m	B4
				X0032B	For Utah Transducer, 3.6m	B4
				X0032C	For Edward Transducer, 3.6m	B4
				X0032D	For BD Transducer, 3.6m	B4
Drager: Cato, Cicero EM, Infinity Delta, Infinity Kappa, Infinity Vista, PB8800, PM8010, PM8014, PM8040, PM8060, Sulla, UM3, Vitara, Zeus IE				X0002A	For Abbott Transducer, 3.6m	B4
			MS22534	X0002B	For Utah Transducer, 3.6m	B4
				X0002C	For Edward Transducer, 3.6m	B4
				X0002L	For SMITH/MEDEX Transducer, 3.6m	B4

OEM Manufacturer & Models	Instrument Connector	Transducers Side (Yoke)	OEM #	Order Code	Descriptions	Price
<b>Compatible Drager/Siemens IBP Adapter Cables</b>						
Drager: Cato, Cicero EM, Infinity Delta, Infinity Kappa, Infinity Vista, PB8800, PM8010, PM8014, PM8040, PM8060, Sulla, UM3, Vitara, Zeus IE			MS22148 3375933	X0002D	For BD Transducer, 3.6m	B4
				X0002E	For Argon/MAXXIM Transducer, 3.6m	B4
				X0002F	For Original B.Braun Transducer, 3.6m	B4
				X0002G	For PVB Transducer, 3.6m	B4
			MS22535	X0002J	For Medex Transducer, 3.6m	B4
				X0002K	For Antmed & ACE Medical, PT-01 Transducer, 3.6m	B4
				X0002L	For BD Transducer, 3.6m	B4
<b>Compatible Datex-Ohmeda IBP Adapter Cables</b>						
AS/3, AS/5, CC- 104, Cardiocap CM-104, Cardiocap I, Cardiocap II, Cardiocap/5, ESTP Module, M-ESTP				X0030A	For Abbott Transducer, 3.6m	B4
			650-217	X0030B	For Utah Transducer, 3.6m	B4
			684104	X0030C	For Edward Transducer, 3.6m	B4
				X0030D	For BD Transducer, 3.6m	B4











OEM Manufacturer & Models	Instrument Connector	Transducers Side (Yoke)	OEM #	Order Code	Descriptions	Price
<b>Compatible Datex-Ohmeda IBP Adapter Cables</b>						
AS/3, AS/5, CC-104, Cardiocap CM-104, Cardiocap I, Cardiocap II, Cardiocap/5, ESTP Module, M-ESTP				X0030E	For Argon/MAXXIM Transducer, 3.6m	B4
				X0030F	For Original B.Braun Transducer, 3.6m	B4
<b>Compatible Emtel IBP Adapter Cables</b>						
FX 2000P, FX 3000, FX 3000C, FX 3000MD, FX 3000P				X0110A	For Abbott Transducer, 3.6m	B4
				X0110C	For Edward Transducer, 3.6m	B4
				X0110D	For BD Transducer, 3.6m	B4
<b>Compatible Fukuda IBP Adapter Cables</b>						
Fukuda				X0026A	For Abbott Transducer, 3.6m	B6
				X0026B	For Utah Transducer, 3.6m	B6
				X0026C	For Edward Transducer, 3.6m	B6
DESH 8000 Series				X0047B	For Utah Transducer, 3.6m	F9
				X0047C	For Edward Transducer, 3.6m	F9
				X0047E	For Argon/MAXXIM Transducer, 3.6m	F9

OEM Manufacturer & Models	Instrument Connector	Transducers Side (Yoke)	OEM #	Order Code	Descriptions	Price
<b>Compatible GE-Marquette IBP Adapter Cables</b>						
Cath-Lab, Dash 1000, Dash 2000, Dash 3000, Dash 3100, Dash 4000, Dash 5000, Eagle, MAC-Lab, PDM Module, Solar 7000, Solar 8000, Solar 9000, Tram 451, Tram Module 100-600, Tram Rac 3, Tram Rac 4A, Tram Scope 100-800 A, Tram Scope 100-800 L			700075-001	X0014A	For Abbott Transducer, 3.6m	B4
			700078-001	X0014B	For Utah Transducer, 3.6m	B4
			2021197-001	X0014C	For Edward Transducer, 3.6m	B4
			2021197-003	X0014C2	For Edward Transducer, 3.6m	B4
			700077-001 684102	X0014D	For BD Transducer, 3.6m	B4
				X0014E	For Argon/MAXXIM Transducer, 3.6m	B4
				X0014F	For Original B.Braun Transducer, 3.6m	B4
				X0014G	For PVB Transducer, 3.6m	B4
			700075-001	X0014J	For Medex Transducer, 3.6m	B4
				X0014K	For Antmed & ACE Medical, PT-01 Transducer, 3.6m	B4
				X0014L	For SMITH/MEDEX Transducer, 3.6m	B4

OEM Manufacturer & Models	Instrument Connector	Transducers Side (Yoke)	OEM #	Order Code	Descriptions	Price
<b>Compatible MEK (Korea) IBP Adapter Cables</b>						
MEK (KOREA)				X0027A	For Abbott Transducer, 3.6m	B3
				X0027C	For Edward Transducer, 3.6m	B3
				X0027F	For Original B.Braun Transducer, 3.6m	B3
<b>Compatible Mindray (China) IBP Adapter Cables</b>						
BeneView T1, BeneView T5, BeneView T6, BeneView T7, BeneView T8, DPM6, DPM7, Passport BeneVision, BeneView, iPM, iMEC series monitors			001C-30-70759	X0016A	For Abbott Transducer, 3.6m	B4
			650-206	X0016B	For Utah Transducer, 3.6m	B4
			0010-21-12179	X0016C	For Edward Transducer, 3.6m	B4
			001C-30-70757	X0016D	For BD Transducer, 3.6m	B4
				X0016E	For Argon/MAXXIM Transducer, 3.6m	B4
				X0016F	For Original B.Braun Transducer, 3.6m	B4
				X0016J	For Medex Transducer, 3.6m	B4
				X0016G	For PVB Transducer, 3.6m	B4
				X0016L	For SMITH/MEDEX Transducer, 3.6m	B4

OEM Manufacturer & Models	Instrument Connector	Transducers Side (Yoke)	OEM #	Order Code	Descriptions	Price
<b>Compatible Mindray (China)-Datascope IBP Adapter Cables</b>						
Passport V, V12, V21			040-000052-00	X0111A	For Abbott Transducer, 3.7m	B4
				X0111B	For Utah Transducer, 3.7m	B4
			040-000054-00	X0111C	For Edward Transducer, 3.7m	B4
			040-000053-00	X0111D	For BD Transducer, 3.7m	B4
				X0111E	For Argon/MAXXIM Transducer, 3.7m	B4
				X0111F	For Original B.Braun Transducer, 3.7m	B4
				X0111G	For PVB Transducer, 3.7m	B4
				X0111J	For Medex Transducer, 3.7m	B4
<b>Compatible Nihon Kohden IBP Adapter Cables</b>						
BSM-6000 series, BSM-6301K, BSM-6501K, BSM-6701K, BSM-9101K, Life Scope J, Life Scope TR				X0028A	For Abbott Transducer, 3.6m	C2
			650-225	X0028B	For Utah Transducer, 3.6m	C2
			JP-920P	X0028C	For Edward Transducer, 3.6m	C2

OEM Manufacturer & Models	Instrument Connector	Transducers Side (Yoke)	OEM #	Order Code	Descriptions	Price
<b>Compatible Nihon Kohden IBP Adapter Cables</b>						
BSM-6000 series, BSM-6301K, BSM-6501K, BSM-6701K, BSM-9101K, Life Scope J, Life Scope TR			684090 JP-902P	X0028D	For BD Transducer, 3.6m	C2
				X0028G	For PVB Transducer, 3.6m	C2
				X0028K	For Antmed & ACE Medical, PT-01 Transducer, 3.6m	C2
				X0028L	For SMITH/MEDEX Transducer, 3.6m	C2
		缺图片，无库存			X0045D	For BD Transducer, 3.6m
SVM-7601/7602, SVM-7621/7622; SVM-7603/7604, SVM-7623/7624; SVM-7501, SVM-7521; SVM-7503, SVM-7523				X0115A	For Abbott Transducer, 3.6m	B4
				X0115B	For Utah Transducer, 3.6m	B4
			JP-753P	X0115C	For Edward Transducer, 3.6m	B4
			JP-752P	X0115D	For BD Transducer, 3.6m	B4
				X0115E	For Argon/MAXXIM Transducer, 3.6m	B4
				X0115F	For Original B. Braun Transducer, 3.6m	B4
				X0115G	For PVB Transducer, 3.6m	B4
				X0115J	For Medex Transducer, 3.6m	B4

OEM Manufacturer & Models	Instrument Connector	Transducers Side (Yoke)	OEM #	Order Code	Descriptions	Price
<b>Compatible Philips IBP Adapter Cables</b>						
Philips: 3536A, 78205A-D, 78341A, 78342A, 78352A, 78354C, 8030A, 8040A, CMS 24, M1006A, M1006A/B, M1006B, M1026A, M1165A, M1175A, M1205A, M1350A...			BCI: MX95102	X0018A	For Abbott Transducer, 3.6m	B4
			650-206	X0018B	For Utah Transducer, 3.6m	B4
			Edwards: 896083021	X0018C	For Edward Transducer, 3.6m	B4
			684081	X0018D	For BD Transducer, 3.6m	B4
				X0018E	For Argon/MAXXIM Transducer, 3.6m	B4
			M1634A	X0018F	For B.Braun Transducer, 3.6m	B4
				X0018G	For PVB Transducer, 3.6m	B4
				X0018J	For Medex Transducer, 3.6m	B4
				X0018K	For Antmed & ACE Medical, PT-01 Transducer, 3.6m	B4
				X0018L	For SMITH/MEDEX Transducer, 3.6m	B4
Philips: V24				X0039A	For Abbott Transducer, 3.6m	B4

OEM Manufacturer & Models	Instrument Connector	Transducers Side (Yoke)	OEM #	Order Code	Descriptions	price
<b>Compatible Spacelabs Medical IBP Adapter Cables</b>						
Spacelabs Medical			700-0295-00	X0038A	For Abbott Transducer, 3.6m	B4
				X0038B	For Utah Transducer, 3.6m	B4
			700-0293-00	X0038C	For Edward Transducer, 3.6m	B4
				X0038D	For BD Transducer, 3.6m	B4
				X0038E	For Argon/MAXXIM Transducer, 3.6m	B4
				X0038F	For Original B.Braun Transducer, 3.6m	B4
				X0038G	For PVB Transducer, 3.6m	B4
				X0038J	For Medex Transducer, 3.6m	B4
				X0038K	For Antmed & ACE Medical, PT-01 Transducer, 3.6m	B4

OEM Manufacturer & Models	Instrument Connector	Transducers Side (Yoke)	OEM #	Order Code	Descriptions	Price
<b>Compatible TERUMO IBP Adapter Cables</b>						
TERUMO SI Heart-Lung Machine; HL20 Extracorporeal Circulation Machine; SAENS system				X0114A	For Abbott Transducer, 3.6m	B8
				X0114B	For Utah Transducer, 3.6m	B8
				X0114C	For Edward Transducer, 3.6m	B8
				X0114D	For BD Transducer, 3.6m	B8
				X0114E	For Argon/MAXXIM Transducer, 3.6m	B8
				X0114F	For Original B.Braun Transducer, 3.6m	B8
				X0114G	For PVB Transducer, 3.6m	B8
				X0114J	For Medex Transducer, 3.6m	B8
				X0114K	For Antmed & ACE Medical, PT-01 Transducer, 3.6m	B8

OEM Manufacturer & Models	Instrument Connector	Transducers Side (Yoke)	OEM #	Order Code	Descriptions	Price
<b>Compatible Comen IBP Adapter Cables</b>						
Comen C50/C60/70/C80/C 90/NC8			700-0295-00	X0120A	For Abbott Transducer, 3.6m	B4
				X0120B	For Utah Transducer, 3.6m	B4
			700-0293-00	X0120C	For Edward Transducer, 3.6m	B4
				X0120D	For BD Transducer, 3.6m	B4
				X0120E	For Argon/MAXXIM Transducer, 3.6m	B4
				X0120F	For Original B.Braun Transducer, 3.6m	B4
				X0120G	For PVB Transducer, 3.6m	B4
				X0120J	For Medex Transducer, 3.6m	B4
				X0120K	For Antmed & ACE Medical, PT-01 Transducer, 3.6m	B4
				X0120L	For SMITH/MEDEX Transducer, 3.6m	B4











## 5 IBP Adapter

### Specification

Cable Material	TPU Jacket, Gray
Connector	Golden Plated Pins
Cable Length	0.3m
Cable Diameter	5.0mm

### Product Features

1. Integrated molding process, strong and durable, easier to clean;
2. The arrow mark of the plug connector is clear, the plug handle is good, more comfortable to use;
3. Latex free.

OEM Manufacturer & Models	Instrument Connector	Transducers Side (Yoke)	OEM #	Order Code	Used with	Price
<b>Compatible Drager IBP Adapter</b>						
Infinity Delta, Infinity Delta XL, Infinity Gamma XXL, Infinity Kappa			5731281	X0004A	Drager IBP adapter cable (See X0001 Series)	F0
<b>Compatible GE-Marquette IBP Adapter</b>						
GE Solar Series, Dash Series, Eagle Series, Tram Series			2005772-001	X0014H	GE-Marquette IBP adapter cable (See X0014 Series)	F2
<b>Compatible Mindray (China)/Datascope IBP Adapter</b>						
Mindray: BeneView T1, DPM 6, DPM 7, BeneView T5, BeneView T6, BeneView T8, BeneView T9			040-001029-00	X0104B	Mindray IBP adapter cable (X0018 Series)	F2
				X0119A	6-pin IBP adapter cables (See X0015 Series)	B4
<b>Compatible Spacelabs IBP Adapter</b>						
Ultraview 90496, 91496			700-0028-00	X0024A	6 pin general IBP adapter cable (See X0038 Series)	F2
<b>Compatible Biolight (China) IBP Adapter</b>						
V6 Vital Sign View A2/A3/A5/A6 Q5/Q7					6-pin IBP adapter cables (See X0015 Series)	B4
<b>Compatible Philips IBP Adapter</b>						
Philips: 3536A, 78205A-D, 78341A, 78342A, 78352A, 78354C, 8030A, 8040A, CMS 24, M1006A, M1006A/B, M1006B, M1026A, M1165A, M1175A, M1205A, M1350A...				X0119C	6-pin IBP adapter cables (See X0015 Series)	B4

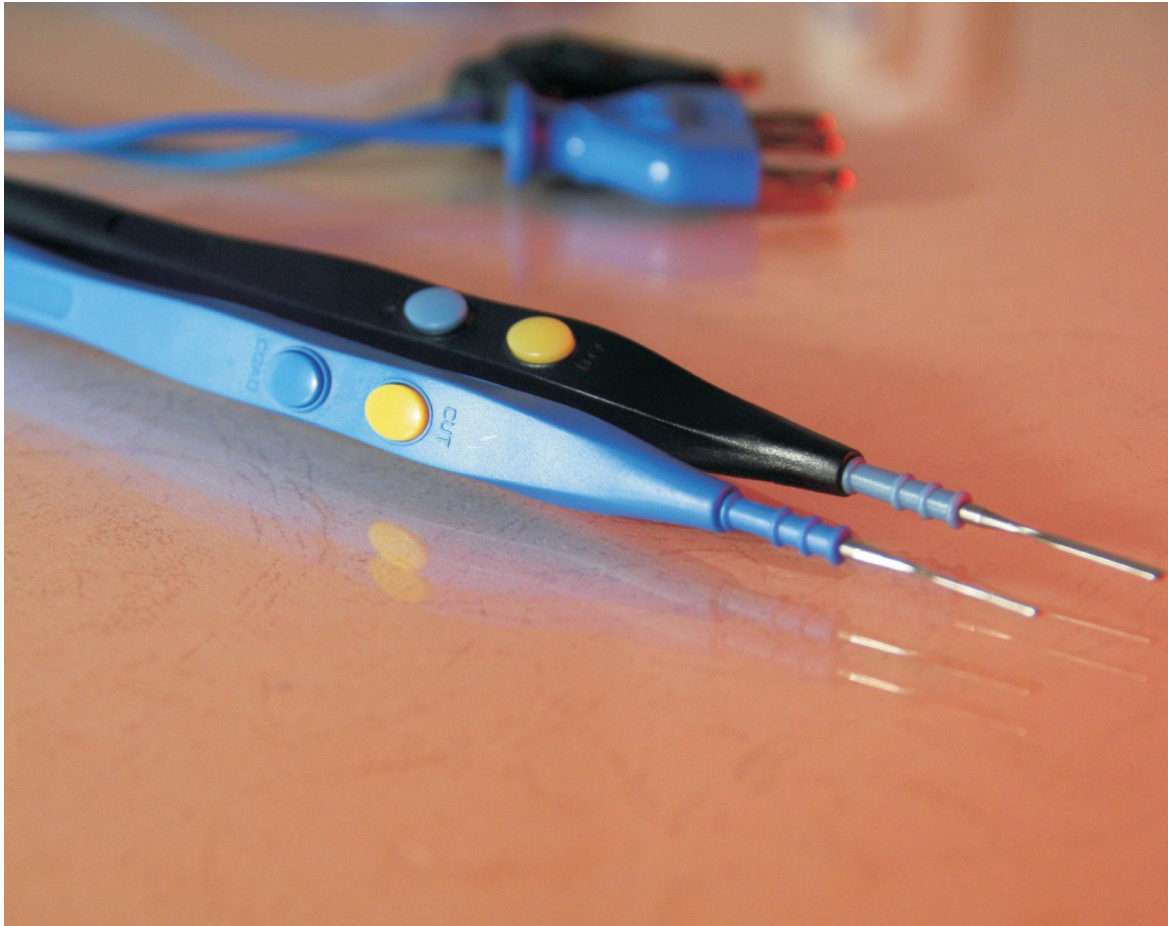

## ESU Pencil & Leadwires

### Code Rule Description

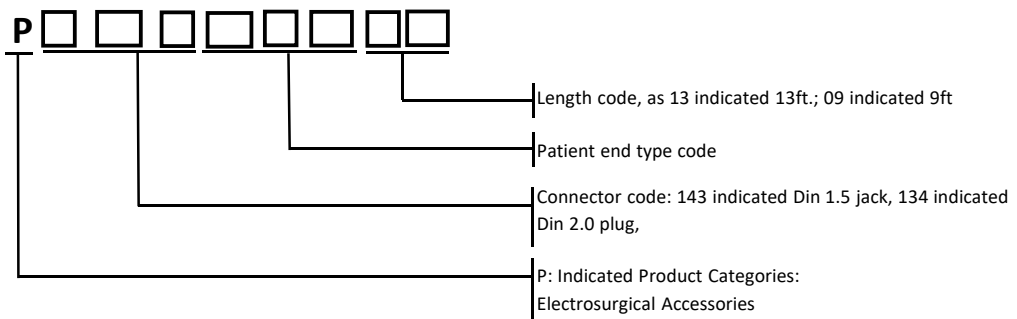

Medlinket can provide high-frequency surgical instrument cables and electrodes (Disposable and Reusable) in a variety of standard and custom.

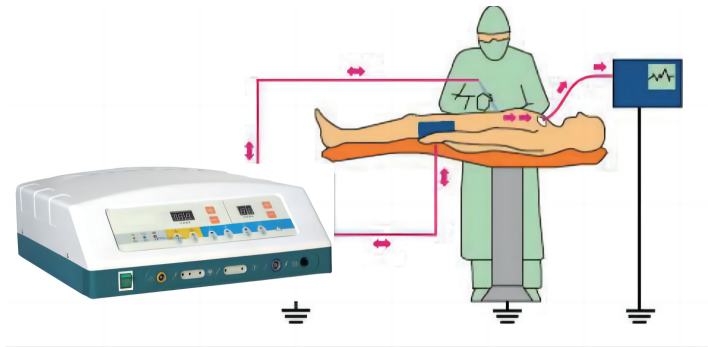

### Instrument



P351-148-13 Connecting cable for electrosurgery (Endoscope)

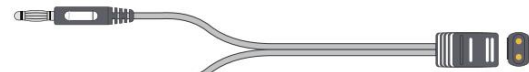

P296-315-10 Bipolar Electrode Cable (US)

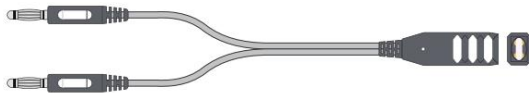

P296-297-10 Bipolar Electrode Cable (EURO)



P283-284-10 Bipolar Electrode Cable (EURO)



P285-286-09 Disposable Electrosurgical pencil



P876-877-10 Reusable Foot Control Electrosurgical pencil



P053-281-13 Patient Return Plate Cable



P281-903-13 Patient Return Plate Cable



P281-280-13 Patient Return Plate Cable

### Active Electrode

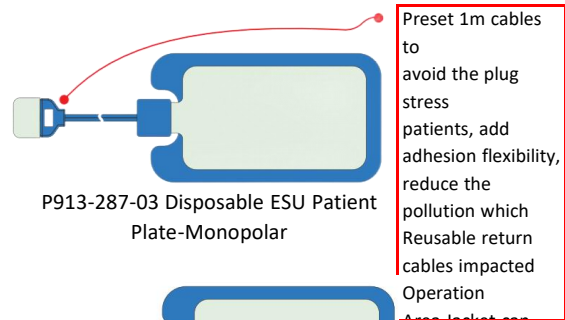

P913-287-03 Disposable ESU Patient Plate-Monopolar

Preset 1m cables to avoid the plug stress patients, add adhesion flexibility, reduce the pollution which Reusable return cables impacted Operation

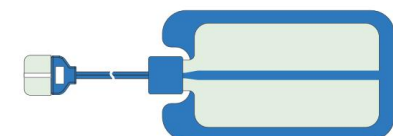

P913-288-03 Disposable ESU Patient Plate-Bipolar







# 1 ESU Pencil

## Product Features

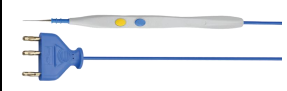
1. Ergonomic design, comfortable feel and excellent mechanical properties;
2. Different shapes of cutting heads can be changed according to the needs of surgery;
3. Closed structure and unique anti-rotation hexagon design, safe and reliable;
4. Extended and increased anti-folding design, strong flexural folding ability, easy to clean, multiple protection;
5. Adaptable plugs can be customized according to adapted model;
6. V type design, easy to plug and unplug, reduced the risk of surgical maximum;
7. Silicone wire, steam sterilizable.

**Medlinket Provides Sterile Disposable Electrosurgical Pencil.**

Compatible Brand	Connector	Order Code	Descriptions	piece
<b>ESU Pencil</b>				
Erbe Valleylab Bovie BOWA Conmed Martin		P285-286-09	Disposable Electrosurgical Pencil Standard Blade Length=40mm Length of wire: 9 ft (2.8m) Cable material: PVC Plug: 3pin banana plug Package: 200pcs/box	
		P285-286-16	Disposable Electrosurgical Pencil Length of wire: 16 ft (4.9m) sterilized by ethylene oxide	
		P285-286-17	Disposable Electrosurgical Pencil Length of wire: 17 ft (5.2m) sterilized by ethylene oxide	
		P285-286-18	Disposable Electrosurgical Pencil Length of wire: 18 ft (5.5m) sterilized by ethylene oxide	
Erbe Valleylab, Bovie,BOWA Conmed,Martin		P285-286-09-R	Reusable Electrosurgical Pencil Standard Blade Length=40mm Length of wire: 9 ft (2.8m) Cable material: silicone Plug: 3pin banana plug Package way:1 piece/bag	
Erbe		P2026-736-15-R	Reusable Electrosurgical Pencil Standard Blade Length=40mm Length of wire: 15 ft (4.5m) Cable material: silicone Plug: φ4.83 banana plug (gold-plated) Package way:1 piece/bag	
Erbe		P876-877-10-R	Reusable Electrosurgical Pencil Standard Blade Length=40mm Length of wire: 10 ft (3m) Cable material: silicone Plug: φ4.0 banana plug Package way:1 piece/bag	

**We supply common active electrode and customized special active electrode according to customer's requirements.**

Medlinket offers a versatile range of single use or reusable specialty electrodes and extensions to help you match the accessory to the surgical application. Single use electrodes include blade, extended blade, needle, extended needle, and ball configurations

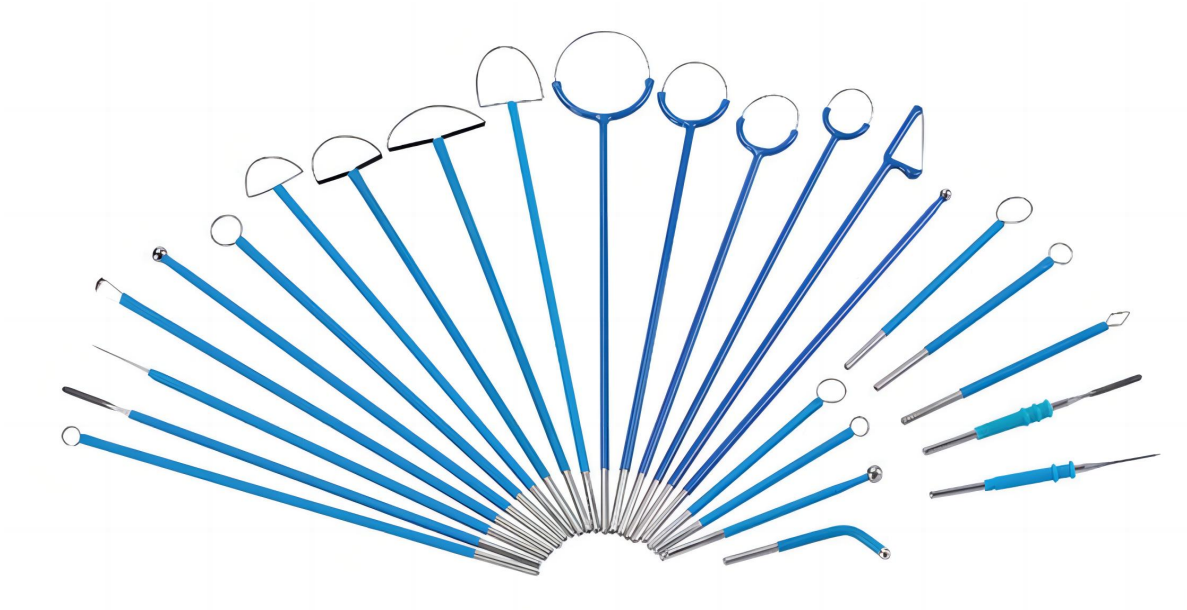

## 2 ESU Pencil Electrode Code Rule Description

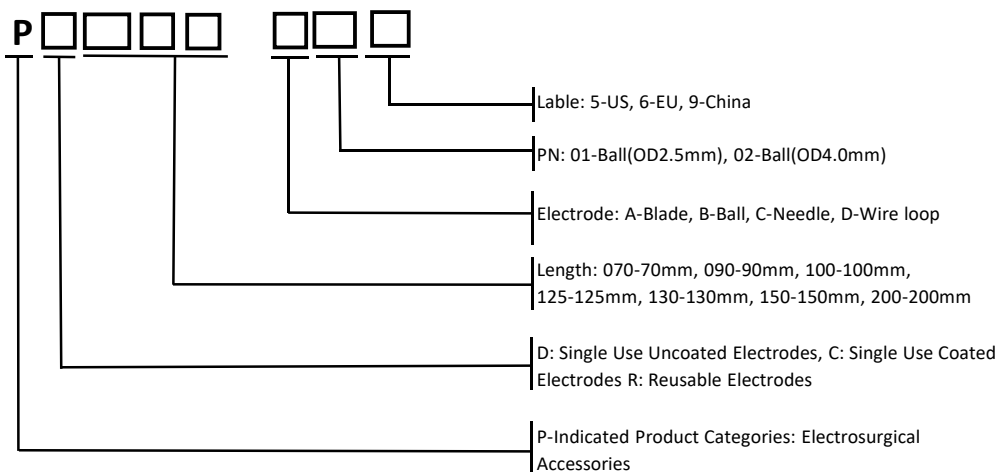

### For Example:

Order Code: PD070A-01 Disposable ESU Uncoated Pencil Electrode/Blade/70mm

Order Code: PC070A-01 Disposable ESU Coated Pencil Electrode/Blade/70mm

Order Code: PR100B-01 Reusable ESU Pencil Electrode/Ball(OD2.5mm)/100mm

**SINGLE-USE INSULATED MONOPOLAR ELECTRODE FOR ELECTROSURGERY**

- WITH HEXAGONAL SHOULDER
- WITH PROTECTIVE COVER
- Uncoated Electrodes OR Coated Electrodes
- SHAFT Ø2.35mm

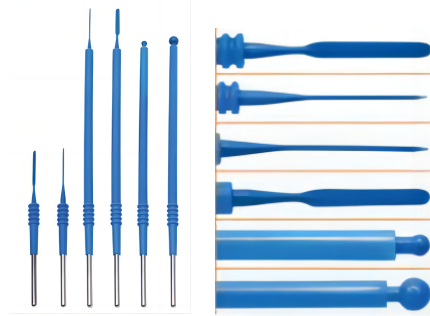

Coated Electrode

View	Description	Length	Order Code		Package	pice
			Uncoated	Coated		
<b>Single-use Insulated Monopolar Electrodes</b>						
	Blade standard Blue color insulator	70mm	PD070A-01	PC070A-01	50 units/box	
	Blade medium Blue color insulator	100mm	PD100A-01	PC100A-01	50 units/box	
	Blade medium, long Blue color insulator	125mm	PD125A-01	PC125A-01	50 units/box	
	Blade long Blue color insulator	130mm	PD130A-01	PC130A-01	50 units/box	
	Blade Plus long Blue color insulator	150mm	PD150A-01	PC150A-01	50 units/box	
	Blade extra long Blue color insulator	200mm	PD200A-01	PC200A-01	50 units/box	
	Ball OD2.5mm Blue color insulator	50mm	PD050B-01	PC050B-01	50 units/box	
	Ball OD4.0mm Blue color insulator	50mm	PD050B-02	PC050B-02	50 units/box	
	Needle thin 1.1mm, Blue color insulator	70mm	PD070C-01	PC070C-01	50 units/box	
	Needle thin 1.1mm medium, long Blue color insulator	125mm	PD125C-01	PC125C-01	50 units/box	

























REUSABLE INSULATED MONOPOLAR ELECTRODES















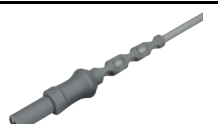

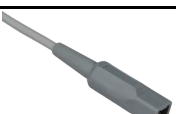

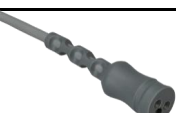
FOR ELECTROSURGICAL PENCIL

- WITH PTFE TUBE
- WITH PROTECTIVE COVER
- Black color insulator
- SHAFT Ø2.35mm



View	Description	Length	Order Code	Package	pice
<b>Reusable Insulated Monopolar Electrodes</b>					
	Tip blade standard insulator Active part 3,5mm Black color insulator	70mm	PR070A-01	50 units/box	
	Tip blade medium, long insulator Active part 3,5mm Black color insulator	90mm	PR090A-01	50 units/box	
	Tip blade medium insulator Active part 3,5mm Black color insulator	100mm	PR100A-01	50 units/box	
	Tip blade medium, long Active part 3,5mm Black color insulator	125mm	PR125A-01	50 units/box	
	Ball OD2.5mm Black color insulator	50mm	PR050B-01	50 units/box	
	Ball OD4.0mm Black color insulator	50mm	PR050B-02	50 units/box	
	Needle thin 1.1mm standard Black color insulator	70mm	PR070C-01	50 units/box	
	Needle thin 1.1mm medium, long Black color insulator	125mm	PR125C-01	50 units/box	

Compatible Brand	Instrument Connector	Patient Connector	OEM #	Order Code	Descriptions	Pice
<b>Electrosurgical Device Cable</b>						
Erbe, T-seris Martin Berchtold Wolf			20192-117	P351-148-13	Length of wire: 13ft (4m) Cable material: silicone Connector type: 7.9 mono plug, Φ3.0 copper tube female plug	
				P351-149-13	Length of wire: 13ft (4m) Cable material: silicone Connector type: 8.0 mono plug, Φ4.0 copper tube female plug	
Bovie, Valleylab, Conmed				P2025-643-10-R	Length of wire: 10ft (3m) Cable material: silicone Connector type: 8.0 mono plug,	
Bovie, Valleylab, Conmed, Wolf			815.033	P2025-2028-10-R	Length of wire: 10ft (3m) Cable material: silicone Connector type: 8.0 mono plug, Φ4.0 red head banana female plug	
Bovie, Valleylab, Conmed				P2025-1979-10-R	Length of wire: 10ft (3m) Cable material: silicone Connector type: 8.0 mono plug, Φ4.0 assembled banana plug	
Martin, Berchtold				P2028-643-16-R	Length of wire: 16ft (5m) Cable material: silicone Connector type: Φ4.0 Red Head Banana Female Plug, Φ4.0 copper tube female plug	
Martin, Berchtold, Wolf			8106.034	P2026-643-15-R	Length of wire: 16ft (5m) Cable material: silicone Connector type: Φ4.0 Red Head Banana Female Plug, Φ4.0 assembled banana plug	
Erbe ACC/ ICC				P2026-643-15-R	Length of wire: 15ft (4.5m) Cable material: silicone Connector type: Φ4.83 banana plug, Φ4.0 copper tube female plug	
Gyrus Acmi Electrosurgical Workstation System 744000			3900	P2730-2731-10-R	Length of wire: 10ft (3m) Cable material: silicone Connector type: 3pin to 3pin	
<b>Electrosurgical Device Cable</b>						
Conmed, Erbe ICC, Erbe VIO, Valleylab, Wolf			8108135	P296-297-10	Length of wire: 10ft (3m) Cable material: silicone Connector type: Φ4.0*2 banana plug,Φ1.8 copper tube (Euro)	
Conmed, Erbe ICC, Erbe VIO, Valleylab			E0509	P296-315-10	Length of wire: 10ft (3m) Cable material: silicone Connector type: Φ4.0*2 banana plug,Φ1.8 copper tube port (US)	
Alcon				P296-316-10	Length of wire: 10ft (3m) Cable material: silicone Connector type: Φ4.0*2 banana plug,Φ2.0 copper tube port (US)	
Erbe ACC/ ICC, T-Serie, VIO				P2028-284-16-R	Length of wire: 16ft (5m) Cable material: silicone Connector type: Φ4.0 red head banana female plug, Electrocoagulation Clamp Shrapnel(Euro)	

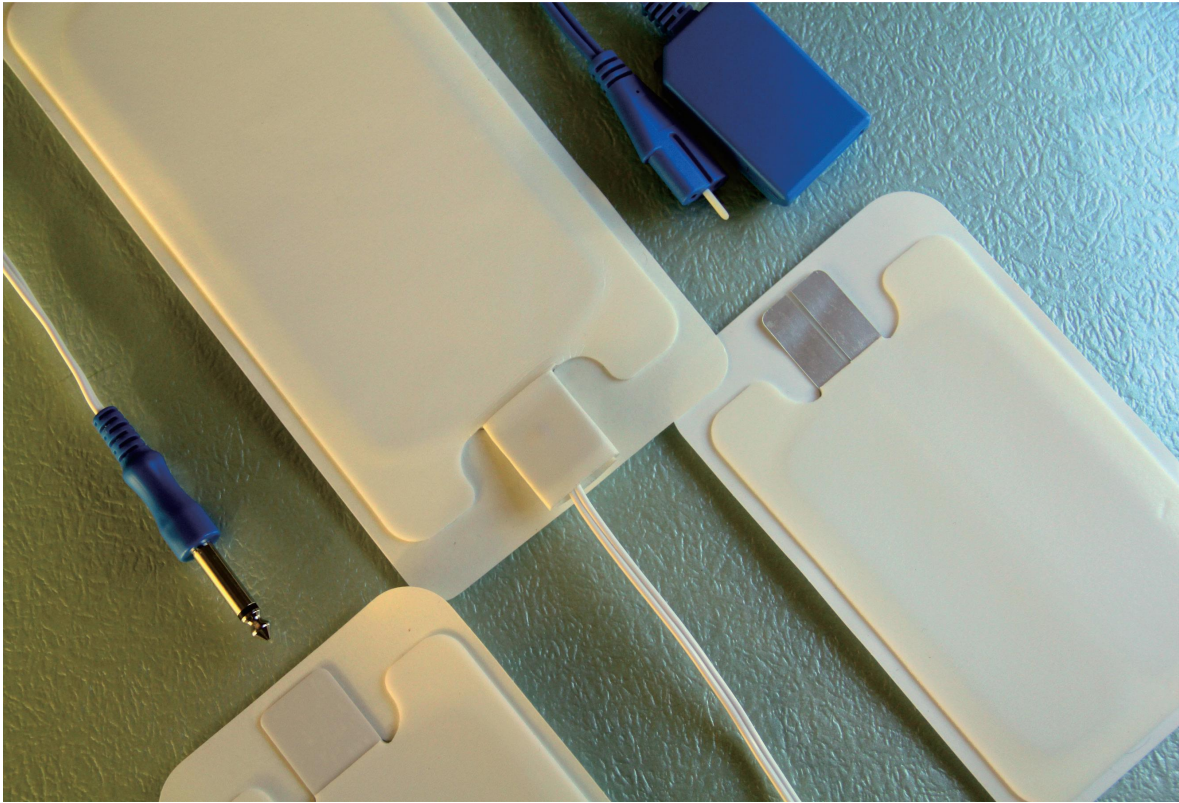

Compatible Brand	Instrument Connector	Patient Connector	OEM #	Order Code	Descriptions	Pice
<b>Bipolar Forceps Connection</b>						
Erbe ACC/ ICC, T-Serie, VIO				P2028-315-16-R	Length of wire: 16ft (5m) Cable material: silicone Connector type: $\Phi$ 4.0 red head banana female plug, $\Phi$ 1.8 copper tube port (US)	
Martin, Berchtold, Aesculap GK55, GK60 Integra, Wolf			06018135	P284-2027-16-R	Length of wire: 16ft (5m) Cable material: silicone Connector type: $\Phi$ 2.0 banana mono plug, electrocoagulation clamp shrapnel(Euro)	
Martin, Berchtold, Aesculap GK55, GK60 Integra				P2027-315-16-R	Length of wire: 16ft (5m) Cable material: silicone Connector type: $\Phi$ 2.0 banana mono plug, $\Phi$ 1.8 copper tube port (US)	
Erbe ACC/ ICC, T-Serie, VIO				P283-284-10	Length of wire: 10ft (3m) Cable material: silicone Connector type: 2*Banana Plug, electrocoagulation clamp shrapnel(Euro)	
Valleylab autobipolar Covidien			E0018	P2020-2021-16-R	Length of wire: 16ft (5m) Cable material: silicone Connector type: $\Phi$ 2.35 Banana Plug, $\Phi$ 1.8mm copper tube (3 pin)	
<b>Bipolar Forceps Connection</b>						
ALSA, Eschmann				P053-281-13	Length of wire: 13ft (4m) Connector type: 6.35 audio plug connector, grounding pad socket (standard)	
BOWA, Conmed, Erbe ICC, Erbe, VIO, Vellelylab				P281-280-13	Length of wire: 13ft (4m) Connector type: "8" shape connector 2* $\Phi$ 2.35 femal contacts (with pin), grounding pad socket (standard)	
Vellelylab, Conmed, Erbe VIO, Erbe international, BOWA ARC				P678-280-13	Length of wire: 13ft (4m) Connector type: "REN" shape connector 2* $\Phi$ 2.35 femal contacts (with pin), grounding pad socket (standard)	
BOWA, Conmed, Erbe ICC, Erbe VIO, Vellelylab non-REM				P677-280-13	Length of wire: 13ft (4m) Connector type: "8" shape connector 2* $\Phi$ 2.35 femal contacts (without pin), grounding pad socket (standard)	
<b>Patient Return Electrode Cable Adapter</b>						
6.3mm audio socket for High frequency electrosurgical equipment				P2610	Mono 6.3mm Plug, 2.35mm Copper tube socket	



## 3 Grounding Pad

### Product Features

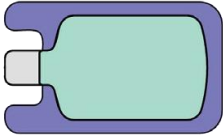
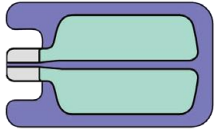
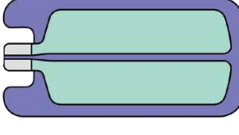
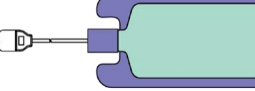
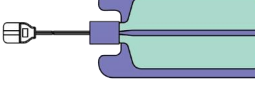
1. Negative plate or circuit negative plate, more uniform current distribution without regard of direction, has good adhesion and conductivity;
2. All materials by biocompatibility trial have been proved to be no-toxic, no-irritating, no-allergic;
3. Various backing materials such as foam and non-woven fabric;
4. Split monopole and bipolar, Suitable for sticking to any different part;
5. Foam and non-woven backing with breathable sticker paste the skin comfortable.

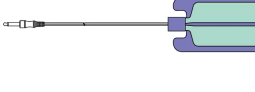







Order Code	Picture	Descriptions	Package	MOQ	piece
<b>Grounding Pad</b>					
287-P		Grounding Pad, Pediatic, Monopolar	1pcs/bag, 140pcs/Carton	1box	
288-P		Grounding Pad, Pediatic, Bipolar plate	1pcs/bag, 140pcs/Carton	1box	
287		Grounding Pad, Adult, Monopolar	1pcs/bag, 50pcs/Carton	1box	
288		Grounding Pad, Adult, Bipolar plate	1pcs/bag, 50pcs/Carton	1box	
P913-287-03		Grounding Pad, Adult, Monopolar	With 1m cable, 1pcs/bag, 50bags/box, 4boxes/Carton	1box	
P913-288-03		Grounding Pad, Adult, Bipolar plate	With 1m cable, 1pcs/bag, 50bags/box, 4boxes/Carton	1box	
P281-288-09		Grounding Pad, Adult, Bipolar plate	With 2.8m cable, 1 pc/bag, 15 bags/box, 6 boxes/Carton	1box	
P053-288-09		Grounding Pad, Adult, Bipolar plate	With 2.8m cable, 1 pc/bag, 15 bags/box, 6 boxes/Carton	1box	



## Ventilator Accessories

### Disposable Flow Sensor

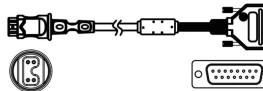
1. Accurately measure the patient's proximal flow and pressure data to better assess the patient's lung condition;
2. Single patient use to prevent cross infection;
3. Clear flow arrow identification and color distinction, easier to identify and operate;
4. Good biocompatibility, latex free, avoid allergic reactions to patients.

Compatible Brand/Models	Photo	OEM #	Order Code	Descriptions	Pice
<b>Respiratory Humidifier Temperature Probe</b>					
Fisher & Paykel 700 series, HC550 humidifier, MR850 humidifier, RT-Series Breathing Circuit		900MR861 900MR869	W0127I	Respiratory Humidifier Temperature Probe 6pin, 6.5ft (2m), 2.252K Ω	
<b>Inspiratory Heated Breathing Circuits Heater Wire Adapter</b>					
Fisher & Paykel 700 series, HC550 humidifier, MR850 humidifier, RT-Series Breathing Circuit, House heater 900MR755(20Ω) 9.4Ω/m		900MR805	W0133Y	Heater Wire Adapter Round 4-pin, 2.6ft (0.8m)	
		900MR806	W0133M	Heater Wire Adapter Round 4-pin, 2.6ft (0.8m)	
		900MR858	W0133R	Heater Wire Adapter Length 1.6ft (0.5m) 4-pin connector to 2-pin connector	
<b>Breathing Circuit Heating Wire</b>					
Fisher & Paykel MR850, MR730 Humidifier			W0136M	Breathing Circuit Heating Wire Length: 1.5m, Impedence: 19±2Ω	
<b>Flow Sensor Cables</b>					
Compatible Drager V500/ BabylogVN500		8416600	CM10-011	4pin to 7pin, 2.0m	
Compatible Drager Babylog8000		8409626	CM10-021	4pin to 7pin, 2.0m	
<b>Flow Sensor</b>					
Hamilton-C6, S1, G5, C3, C2, C1, T1, MR1, Raphael, Galileo		281637/05	FT800	1.88m, Φ 15mm, 10pcs/box	

# Customer Service Policies

## How to Order

**By Phone:** Call +86 755 61120085, during our normal business hours of 8:00 AM to 5:30 PM (Beijing Time) Monday to Friday.

**By Fax:** Dial +86 755 61120055. Faxed orders are accepted 24 hours a day, but orders received after 3:00 PM on Friday will not be processed until the following Monday.

**By Email:** Send to [marketing@med-linket.com](mailto:marketing@med-linket.com). As with faxed orders, any emailed orders received after 3:00 PM on Friday will not be processed until the following Monday.

## Payment Methods

**Wire Transfer:** If you would like to remit payment directly to our bank, please call the phone number(s) above to request our bank information. When requesting our bank information, please have your Sales Order number ready. To expedite the payment process, please reference the Sales Order number on the transfer documentation. A processing fee of \$25.00 will be added to transfers less than \$1,000.00.

At this moment, the legal bank account of Med-linket is as bellowing:

- US Correspondent Bank: CITIBANK NA
- Swift BIC: CITIUS33
- Beneficiary Bank: Agricultural Bank of China Shenzhen Branch Longhua Sub-branch
- Swift BIC: ABOCCNBJ410
- Address: Agricultural Bank Building, Renminbei road, Longhua Town, Baoan District, Shenzhen, 518109, P.R.China
- Account No: 41029600040006714
- Account Name: MED-LINKET

All items shipped to MED-LINKET, regardless of purpose, must be clearly marked on the outside of the box or on internal documentation with

the following. Any package that is not marked as specified may be refused delivery or discarded:

- Complete return address
- Contact name
- Contact telephone number
- RMA Number (This Number will be got from Customer Service Dept. Hot-line: +86 755 61120299-834, E-mail: [user02@med-linket.com](mailto:user02@med-linket.com)).

For all warranty return items, prior authorization to return merchandise must be obtained by contacting Med-Linket and requesting an RMA# (Return Material Authorization number). This number must appear on the outside of the shipping container or on the documentation that accompanies the shipment. Once RMA # is issued the items must be returned to MED-LINKET within 30 days, or the RMA# will be cancelled and a new number must be issued.

**Shortages:** MED-LINKET will not be responsible for short-shipped items that are not reported within three (3) business days of delivery.

### Warranty Terms:

- 1) No warranty period for disposable products;
- 2) 6 months after delivery date for Reusable NIBP Cuff, Reusable ECG, EEG Electrodes and EEG Cord, ESU Pencil and Patient Return Plate Cable;
- 3) 12 months after delivery date for Reusable SpO2 Sensors, SpO2 Sensor Extension Cable, Temperature Probes, ECG Patient Cable and Lead wires, IBP Cable, Temp-Pulse Oximeter.

**Freight Charges & Restocking Fee:** Customer is responsible for all transport cost related to the return of items under warranty or for repair. We cannot reimburse freight costs or other related transport costs for any returned goods.

Under no circumstances is any third party authorized to use Med-Linket's DHL, TNT, UPS and Federal Express account numbers without the prior written consent of Med-Linket. Freight collect shipments are not accepted.

- If Med-Linket determines that returned items are covered under warranty, then the items will be shipped back to customer freight prepaid via DHL, TNT, UPS and Federal Express;
- If items are not covered under warranty, customer is responsible for repairing costs and return shipping costs;
- Overstock returns within 90 days will be charged for a 25% or 50% (within 6 months) administration fee;
- Merchandise returned due to customer order error will be charged for 10% (within 15 days) or 20% (within 90days) administration fee;
- Med-Linket will not accept returns after 6 months from the delivery date.

**Credit:** Some items, such as special orders, are not returnable. All returned goods should be in saleable condition and in the original packaging. Credit will only be issued upon receipt and inspection of items, and is subject to Med-Linket approval.

## Shipping

**Terms:** Shipping charges are not included in the published prices and are the responsibility of the purchaser. Shipping charges will be added to your Invoice. For prepaid orders, the items will be shipped upon receipt of balance due. For orders on account, items will be shipped as long as credit limits have not been exceeded and the account is not past due.

**Same Day Shipping:** All in-stock orders received before 1:30 PM (Beijing Time) will be shipped the same day as long as the payment requirements set forth above are met.

**Carrier & Rush Orders:** Our standard carriers are DHL, TNT, UPS and Federal Express. If an alternate carrier is requested, an administrative fee of \$25.00 will be applied to your invoice unless a third party account number is supplied.

**Insurance:** If customer requests that the shipment not be insured, then both UPS and FedEx will only insure the first US \$100.00—MED-LINKET is not responsible for any additional amount and the balance due shown on the Med-Linket invoice must still be remitted in full.

If customer requests that the shipment be insured, the all the insurance fee will be responsible by purchaser.

If a “Commercial Invoice” is requested which excludes such items as taxes or shipping charges, the shipment will be insured for the amount shown on the Commercial Invoice, If the package is lost or damaged, the customer can claim only the amount shown on the Commercial Invoice but will still be held liable for the total amount of the original Med-Linket invoice.